

2555.921 Shown

MODEL NUMBER:

- ❑ **2555.921 Deck-Mount Tub Filler**
FloWise® Personal shower. Metal lever handles.
- ❑ **2555.920 Deck-Mount Tub Filler**
Less personal shower. Metal lever handles.

AVAILABLE ACCESSORY:

- ❑ **8888.900 Deck Mount Tub Filler Flex Hose Kit**

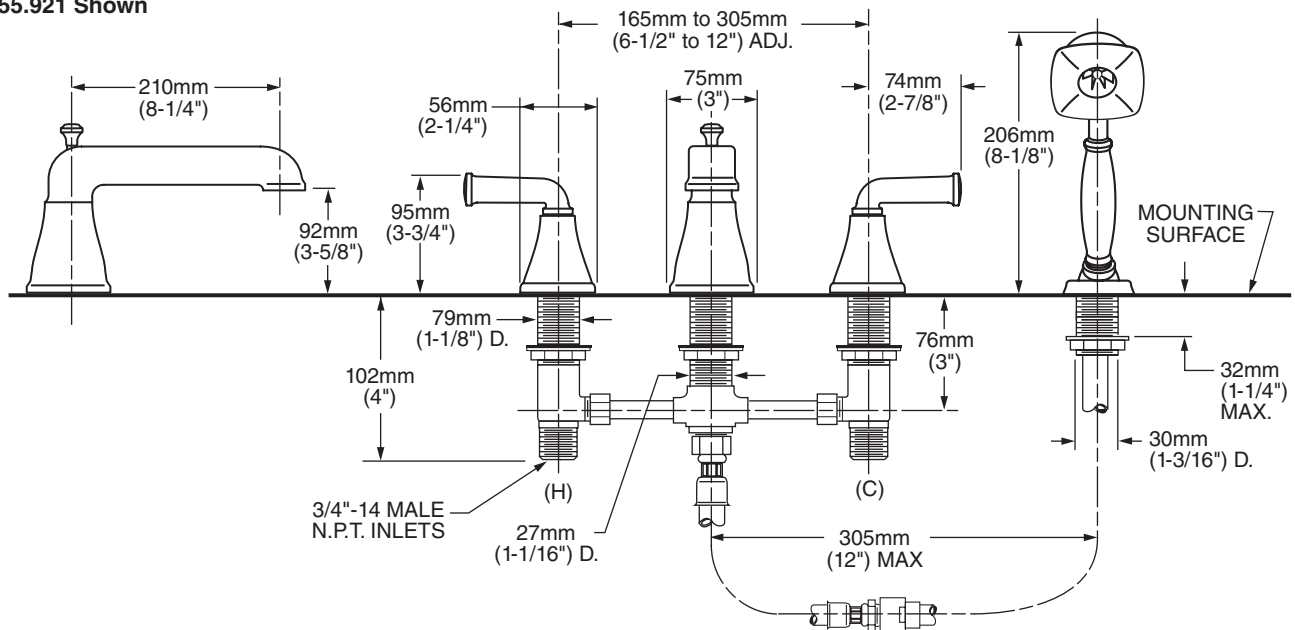

GENERAL DESCRIPTION:

Durable cast brass spout with built-in diverter (on 2555.921). Rigid brass and copper waterway below deck provided for 12" installations (can be cut for 8" installations). Brass valve bodies with 3/4" NPT inlets with brass coupling nuts. 1/4 turn washerless ceramic disc valve cartridges. Personal shower features FloWise® technology, a 6-1/2' long hose (1-1/2' heavy duty hose and 5' decorative hose.) 1.5 gpm/9.5L/min. maximum flow rate.

PRODUCT FEATURES:

- Brass Construction:** Durable. Easy to clean. Ideal for prolonged contact with water.
- Ceramic Disc Valve Cartridges:** Assures a lifetime of smooth handle operation and drip-free performance.
- Choice of Finishes:** Wide range of durable finishes.

SUGGESTED SPECIFICATION:

Two handle deck-mount tub filler shall feature cast brass construction with brass and copper waterway. Shall also feature 1/4 turn washerless ceramic disc valve cartridges. Fitting shall be American Standard Model # 2555.92_._.



CODES AND STANDARDS

These products meet or exceed the following codes and standards:

**ASME A112.18.1
CSA B125**

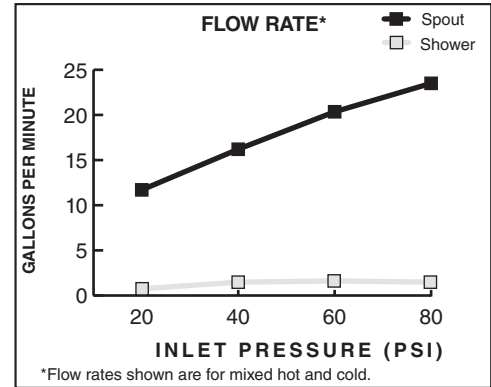
Check local plumbing codes. Some installations may require a vacuum breaker.



Product Number	Description	Finish Options		
		Polished Chrome	Oil Rubbed Bronze	PVD Satin Nickel
		002	224	295
2555.921	Deck-Mount Tub Filler. FloWise® Personal shower. Metal lever handles. 			
2555.920	Deck-Mount Tub Filler. Less personal shower. Metal lever handles. 			
8888.900	Deck-Mount Tub Filler Flex Hose Kit	N/A	N/A	N/A

 Meets the American Disabilities Act Guidelines and **ANSI A117.1** Requirements for the physically challenged.