

American Standard

Installation Instructions

4175.100

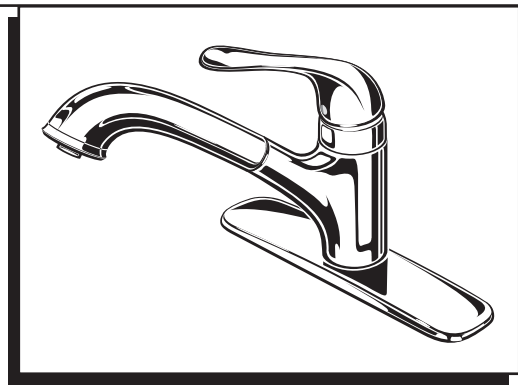

Certified to comply with ANSI A112.18.1M
M968986 Rev. 1.3

COLONY SOFT

SINGLE CONTROL KITCHEN PULL-OUT FAUCET

Thank you for selecting American-Standard...
the benchmark of fine quality for over 100 years.

To ensure that your installation proceeds smoothly...
please read these instructions carefully before you begin.

RECOMMENDED TOOLS



Regular Screwdriver



Phillips Screwdriver



Adjustable Wrench



Plumbers' Putty or Caulking

1 INSTALL FAUCET WITH OR WITHOUT DECK ESCUTCHEON

CAUTION

Turn off water at
main supply.

- **(A) Installation with ESCUTCHEON (1).** Apply a bead of putty to bottom edge of ESCUTCHEON with PUTTY PLATE (1). Insert supply HOSES (2) and SHANK (3) through hole of ESCUTCHEON with PUTTY PLATE (1) and mounting surface. Follow mounting instructions below to secure faucet to mounting surface.
- **(B) Installation less ESCUTCHEON (1).** Discard ESCUTCHEON with PUTTY PLATE (1). Insert supply HOSES (2) and SHANK (3) through mounting hole and seat SPOUT BASE onto sink or mounting surface. Do not use putty.
- Insert HOSES (2) through RUBBER WASHER (4), BRASS WASHER (5), and threaded LOCKNUT (6).
- Assemble RUBBER WASHER (4), BRASS WASHER (5), and threaded LOCKNUT (6) onto SHANK (3) from underside of sink or mounting surface. Hand tighten LOCKNUT (6) and check that rotation of HANDLE (7) from HOT to COLD is centered.
- Use a screwdriver to tighten SCREWS (8) on LOCKNUT (6). Work your way around LOCKNUT (6), tightening the screws slightly each time until all are snug to ensure even pressure.

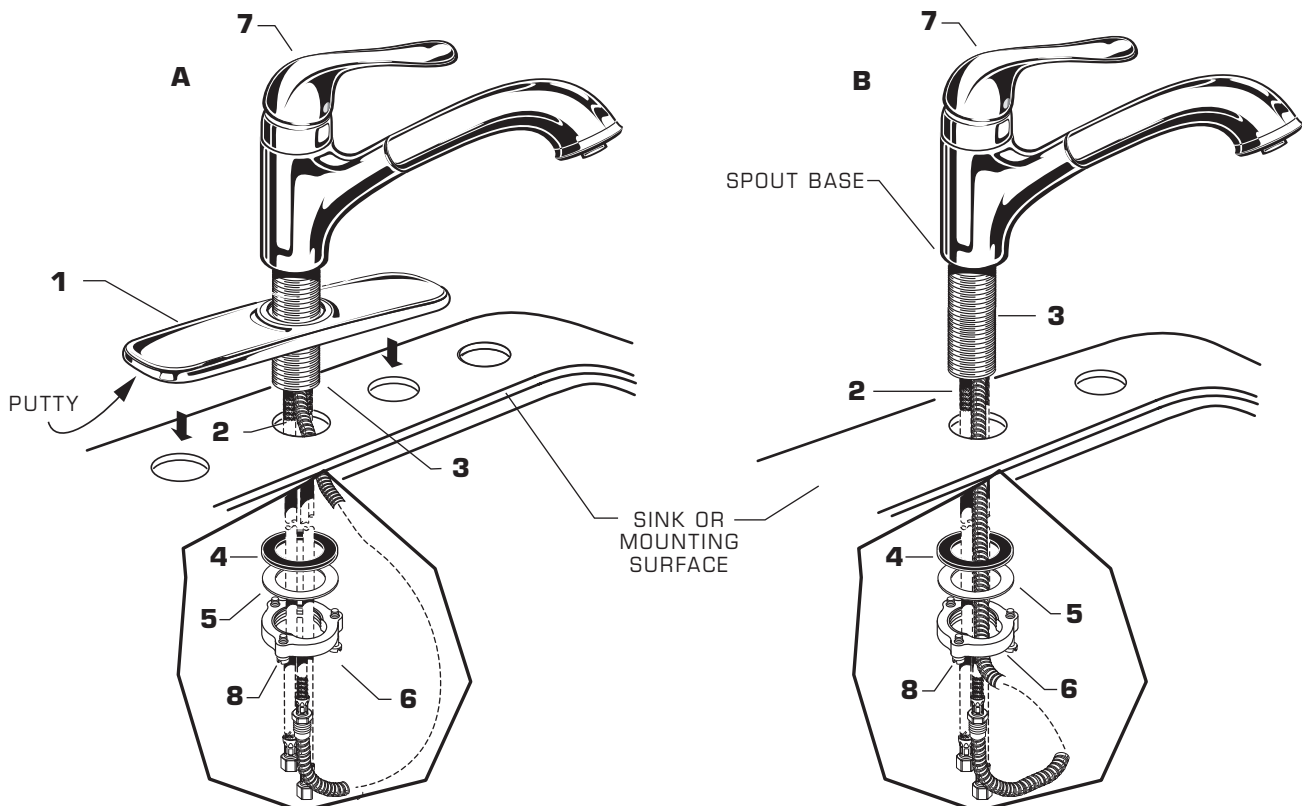

2 MAKE WATER SUPPLY CONNECTIONS

- Turn off hot and cold water supplies before beginning.
- Connect FLEXIBLE SUPPLIES (1, 2) directly to wall supplies. Connection on fitting supplies are 3/8" compression. Connect left supply (Marked with a Red Stripe) to Hot and right supply (Marked with Blue Stripe) to Cold wall supply. Use adjustable wrench to tighten connections. Do not over tighten.
- Faucet supplies are 21" long from faucet base.
- **Note:** If additional supply length is required, installer must purchase additional parts separately.
- **Important:** If SUPPLY HOSES (1, 2) are too long, loop as illustrated to avoid kinking.

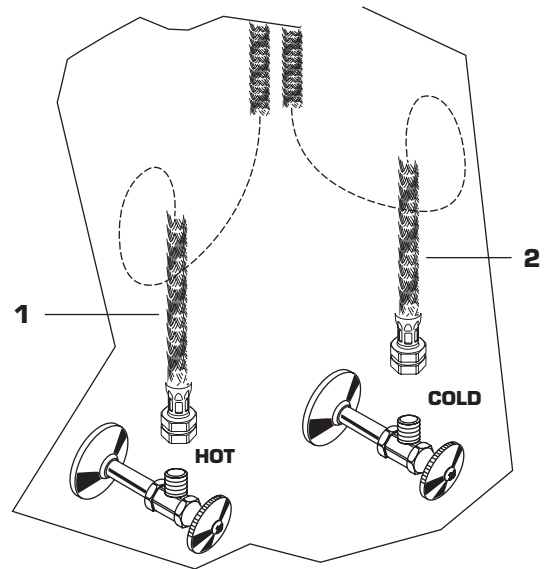

3 INSTALL WEIGHTS

- With HAND SPRAY (1) seated in FAUCET (2), install WEIGHTS (4) onto HOSE (3) using two SCREWS (5). Locate the WEIGHTS (4) two feet (2') from the underside of the sink deck. Tighten SCREWS (5) firmly.
- Install SEAL WASHER (6) into COUPLING NUT (7). Tighten COUPLING NUT (7) to HOSE END (3a).

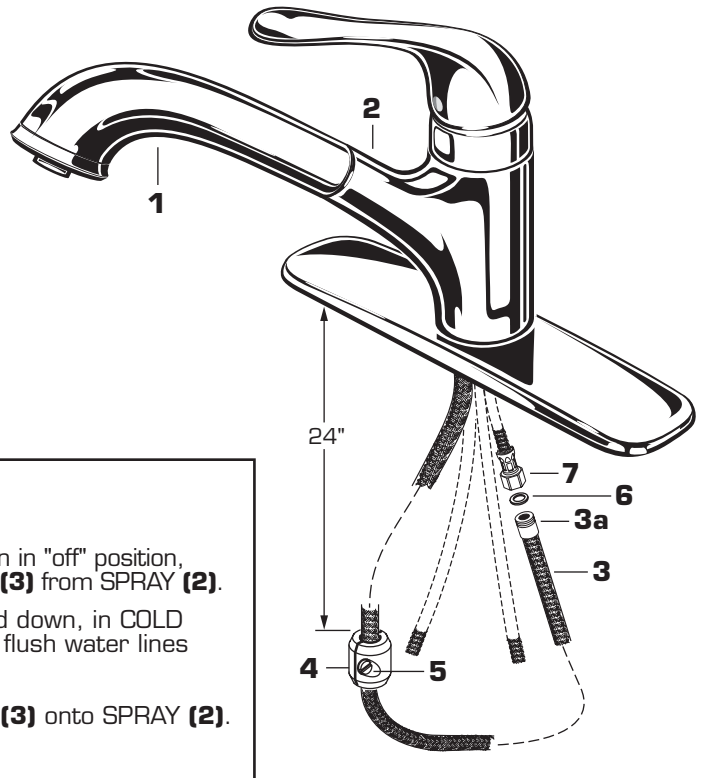

4 TEST INSTALLED FAUCET

- Move HANDLE (1) down into "off" position.
- Turn on water supplies.
- Check connections for leaks. (See Section 5)
- With HANDLE (1) down in "off" position, unthread SPRAY FACE (3) from SPRAY (2).
- Operate handle up and down, in COLD and HOT positions, to flush water lines thoroughly.
- Replace SPRAY FACE (3) onto SPRAY (2).

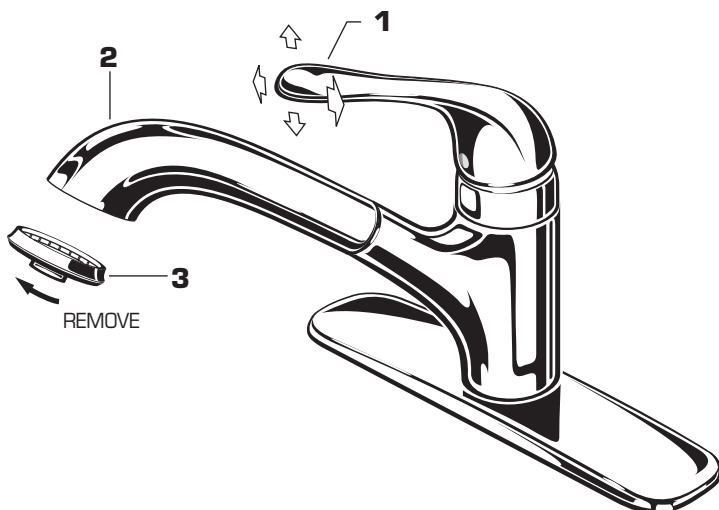

- Check HAND SPRAY (2) operation:
- With faucet on pull SPRAY FACE (3) down to switch from stream to spray.

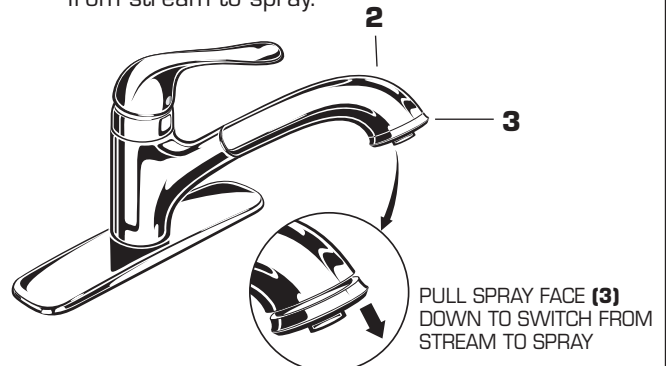

5 CHECK CONNECTIONS FOR LEAKS.

- Move HANDLE down into "off" position.
- Turn on water supplies and check connections for leaks. ➡
- Operate HANDLE (2) up and down, left and right to flush water lines thoroughly.
- Operate HAND SPRAY and check connections for leaks. ➡

CHECK CONNECTIONS FOR LEAKS ➡

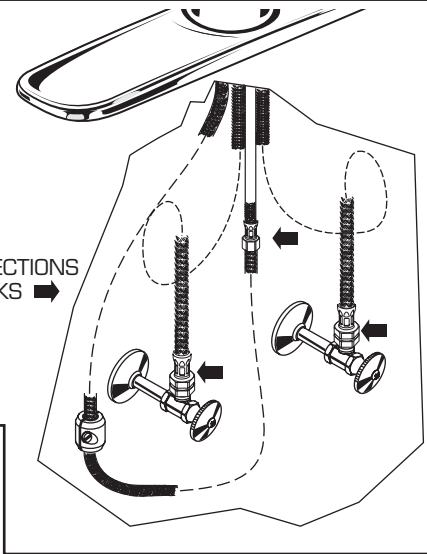

6 SERVICE

- If faucet drips, operate HANDLE several times from "off" to "on." Do not apply excessive force. FLOW CONTROL DEVICE may accumulate dirt. To remove the FLOW CONTROL DEVICE, unthread SPRAY AND HOSE ASSEMBLY and rinse clean FLOW CONTROL DEVICE.

■ Clogged CARTRIDGE outlets or inlets may cause reduced flow.

To clean, first turn off water supply then:

- Remove INDEX BUTTON (1), loosen HANDLE SCREW (2) and remove HANDLE (3).
- Unthread the ESCUTCHEON CAP (4). Unthread three MOUNTING SCREWS (5).
- Lift CARTRIDGE (6) off MANIFOLD (7) and remove CARTRIDGE SEALS (8).
- Clean MANIFOLD (7), CARTRIDGE (6) ports and SEALS (8).
- Place SEALS (8) into CARTRIDGE PORTS (6A).
- Place CARTRIDGE (6) onto MANIFOLD (7) and tighten MOUNTING SCREWS (5) alternately.
- Replace ESCUTCHEON CAP (4), HANDLE (3), tighten HANDLE SCREW (1) and install INDEX BUTTON (2).

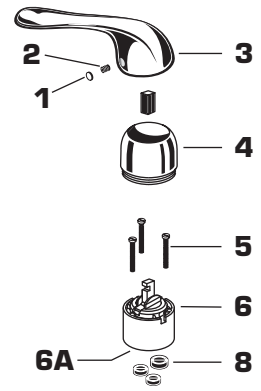

HOT LIMIT SAFETY STOP ADJUSTMENT

By restricting handle rotation and limiting the amount of hot water allowed to mix with the cold, the HOT LIMIT SAFETY STOP reduces risk of accidental scalding. To set the maximum hot water temperature of your faucets, all you need to do is adjust the setting on the HOT LIMIT SAFETY STOP.

- Remove HANDLE BUTTON (1) and loosen SET SCREW (2). Pull HANDLE (3) off valve stem. Pull off CAP (4). Use a flat blade screwdriver or your fingers to pull up and rotate red HOT LIMIT SAFETY STOP (5). Follow **Step "A" or "B"** to adjust min./max. discharge temperature. "0" being the hottest to "7" the coldest temperature setting. Factory set at "0".

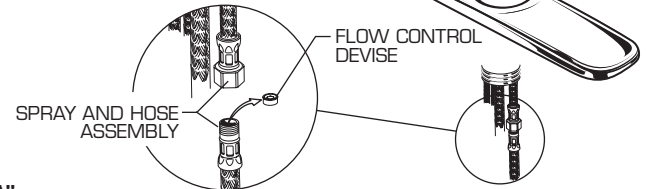

- Replace ESCUTCHEON CAP (4), HANDLE (3), tighten HANDLE SCREW (1) and install INDEX BUTTON (2).

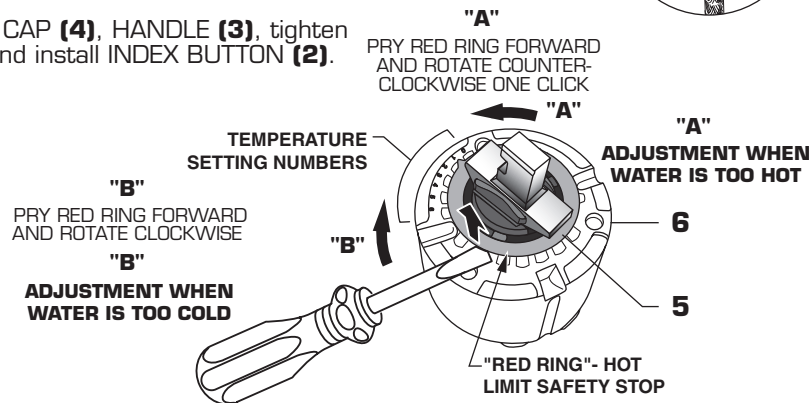

7 CARE:

DO: SIMPLY RINSE THE PRODUCT CLEAN WITH CLEAR WATER. DRY WITH A SOFT COTTON FLANNEL CLOTH.
DO NOT: DO NOT CLEAN THE PRODUCT WITH SOAPS, ACID, POLISH, ABRASIVES, HARSH CLEANERS, OR A CLOTH WITH A COARSE SURFACE.