

Submitted Model No.: _____

Specific Features: _____

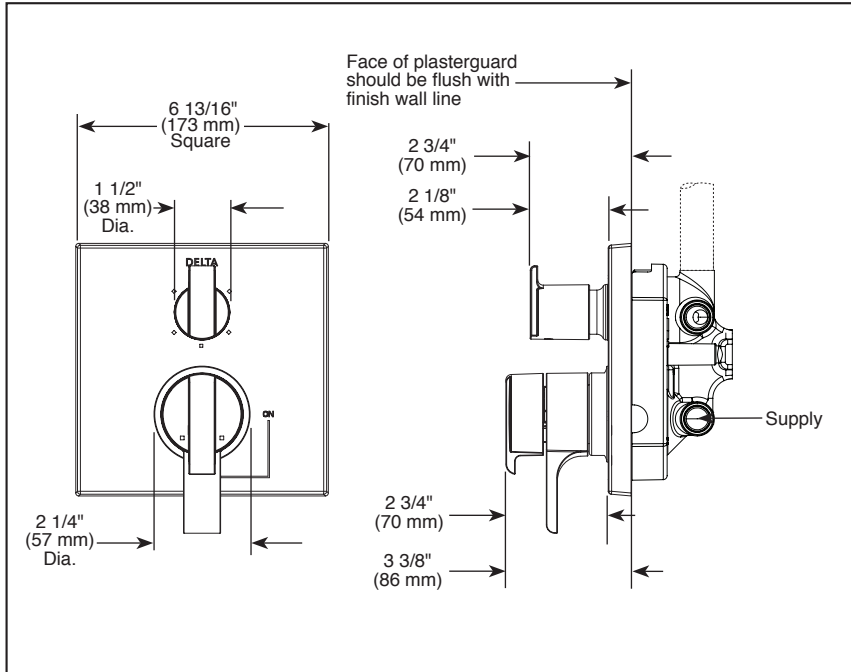

▲ Designate Proper Finish Suffix



INTEGRATED SHOWER DIVERTER TRIM

- Angular Modern Valve Trim with Three Function Diverter (T27867)
- Angular Modern Valve Trim with Six Function Diverter (T27967)
- Three Lever Handles

FEATURES:

- Monitor® 17 Series pressure balanced dual function bath mixing valve trim
- Three or six function diverter

STANDARD SPECIFICATIONS:

- Main control utilizes dual-function pressure balanced cartridge
- Maintains a balanced pressure of hot and cold water even when a valve is turned on or off elsewhere in the system
- For use with MultiChoice® Universal rough valve body (R22000 Series)
- Top handle controls diverter functions
- Bottom handle controls on/off and adjusts volume; dial controls temperature
- Field adjustable to limit handle rotation into hot water zone
- Bottom handle 90° Maximum rotation
- Red/Blue indicator markings
- Three function diverter for 2 individual positions, 1 shared position
- For two individual functions, no shared functions, order additional RP71718
- Six function diverter for 3 individual positions, 3 shared positions
- For three individual functions, no shared functions, order additional RP71718
- Cartridges included
- Standard installation allows up to 1 1/8" finished wall thickness
- Thick wall installation kit (RP90543▲) can be ordered to allow for up to 2 1/8" finished wall thickness
- Not recommended for tub spout applications

WARRANTY

- Lifetime limited warranty on parts (other than electronic parts and batteries) and finishes: or, for commercial users, for 5 years from date of purchase.
- 5 year limited warranty on electronic parts (other than batteries); or, for commercial users, for 1 year from the date of purchase. No warranty is provided on batteries.

COMPLIES WITH:

- ASME A112.18.1 / CSA B125.1
- Indicates compliance to ICC/ANSI A117.1

Maximum Flow Rate Guide

Rough	Cartridge	Outlet	40 psi	60 psi	80 psi
R22000	17S	Shower	4.7 gpm	5.8 gpm	6.7 gpm
R22000-WS	17S	Shower	4.4 gpm	5.4 gpm	6.3 gpm

Based on 6 Setting Diverter



55 E 11th Street, Indianapolis, Indiana 46280
350 South Edgeware Road, St. Thomas, ON N5P 4L1
© 2016 Masco Corporation of Indiana

Delta reserves the right (1) to make changes in specifications and materials, and (2) to change or discontinue models, both without notice or obligation. Dimensions are for reference only. See current full-line price book or www.deltafaucet.com for finish options and product availability.

DSP-B-T27867 Rev. C