

Combustion Air System

**Triple-wall stovepipe system
designed to provide air for combustion
through its components.**

ULC S641.

DVL®

**Double-wall interior
close clearance stovepipe for
connecting woodstoves to chimney.**

ULC S641.

DuraBlack®

**Single-wall interior
stovepipe for connecting
woodstoves to chimney.**



Specifications

Applications

Triple-wall chimney system designed to provide air for combustion through its components. Provides a 3" air intake for the appliance.

Materials and Construction

.016" stainless steel inner wall.
.018" galvalume middle wall.
.018" galvalume outer, painted black.

Clearances

6" clearance to walls. 8" clearance to ceiling on horizontal pipe that runs below the ceiling.

Diameters

6" and 8"

Listing

ULC-S641
c-UL-us



ULC S641 System

Combustion Air System For DuraTech®, DuraTech® Canada and DuraPlus® HTC

The Combustion Air System (CAS) is a system designed to bring in outside combustion air directly to your wood stoves. This eliminates the use of conditioned inside air for combustion, improving the efficiency of central heating systems.

Combustion Air System is a patent-pending design that pre-heats combustion air. Inbound air is circulated through baffles around the heated areas of the support box or wall thimble. For DuraTech and HTC, the pre-heated air is supplied between the stove pipe's 2nd and 3rd wall, while the 1st wall maintains high stove temperatures.

CAS enables outside air to be used as combustion air below grade. The wall thimble for wood stoves provides combustion air to appliances used in below grade (basement) installations. Wood stoves utilize the triple wall stove pipe. CAS also minimizes down-drafts in below grade installations. It does not consume warm indoor air for combustion and not subject to oxygen starvation, poor draft and other problems associated with 'tight' energy efficient homes.

This system simplifies installation with only one wall or ceiling penetration, eliminating the need for a second penetration in the building envelope to introduce combustion air. The design is simple and elegant with decorative black finish. All products are factory finished in matte black.

Combustion Air Systems is also available for pellet stoves, see details in the PelletVent Pro section of the catalog.



Single- and Double-Wall Stovepipe Systems

DVL double-wall or DuraBlack single-wall stovepipe completes the venting system when used with one of DuraVent's chimney products, such as DuraTech, DuraTech Canada, DuraPlus, or DuraPlus HTC.

DVL®

DVL's double-wall, air-insulated design reduces clearances to combustibles from 18" to 6", the closest clearance to a wall of any connector pipe. DVL improves stove performance by maintaining high flue gas temperatures for a strong, steady draft. Because the inner wall is stainless steel the flue heats up faster, stays hot longer, minimizes the formation of creosote, and has the same life expectancy as the chimney. Adjustable lengths eliminate the need for cutting or crimping.

Required for Manufactured Home installations. See appliance manufacturer's installation instructions.

DuraBlack®

For an economical, drip free, single-wall stovepipe, DuraBlack is an excellent choice. Built to DuraVent's high standards, DuraBlack is constructed with die-formed end fittings. Adjustable lengths eliminate the need for cutting and crimping. Available in 24 gauge lock-seam, 22 gauge stainless steel and heavy duty 22 gauge welded seam.



Specifications

DVL

Applications

Double-wall interior stovepipe for connecting wood stoves to manufactured chimney.

Materials and Construction

.016" stainless steel inner wall.
.018" galvanized outer, painted black.

Clearances

6" clearance to walls. 8" clearance to ceilings, including cathedral ceilings.

Diameters

6" - 8"

Listings

c-UL-us listed to ULC S641 (MH14089).



DuraBlack

Applications

Single-wall interior stovepipe for connecting wood stoves to manufactured chimney.

Materials and Construction

DuraBlack: 24-gauge steel construction. Lock-seamed. Painted black.

DuraBlack Welded: 22-gauge steel construction.

DuraBlack Stainless Steel: .020" 430 stainless steel

Diameters

DuraBlack: 6" - 10"

DuraBlack Welded: 6"

DuraBlack Stainless Steel: 6" and 8"

DuraBlack - Single-Wall Stovepipe

DuraBlack Stovepipe Kit



Kit includes: 14" DuraBlack Slip Connector w/Trim and (2) 24" DuraBlack Single-Wall Black Pipe.

Use kit to connect between appliance and chimney for a typical 8' through-the-ceiling installation.

SIZE	6"
ORDER #	6DBK-KSP
STOCK #	810000955

DuraBlack Slip Connector w/ Trim

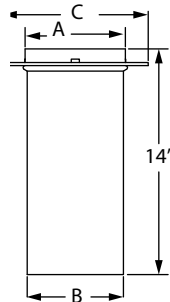

Used to adapt DuraBlack pipe to 6" - 8" Ceiling Support Box, including DuraTech, DuraPlus, and DuraPlus HTC systems. The Slip connector can also be added to 6" - 8" DuraTech finishing collar. Adds 3"-13" of length to rigid pipe. Provides a strong mechanical connection.

SIZE	6"	7"	8"
A	6 1/4"	7 1/4"	8 1/4"
B	6"	7"	8"
C	9"	11"	11"
ORDER #	6DBK-SC	7DBK-SC	8DBK-SC
STOCK #	810000957	810000983	810000997

DuraBlack Slip Connector

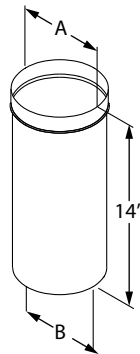

Use to adapt DuraBlack pipe to ceiling support box or finishing collar. Adds 3" - 13" of length to rigid pipe. Allows drip-free installation without cutting the pipe. Can be used in line to create a telescoping combination when used with a straight length of pipe. Requires screws.

SIZE	10"
A	10 3/16"
B	9 15/16"
ORDER #	10DBK-SC
STOCK #	810001019

DuraBlack Telescoping Length w/ Trim

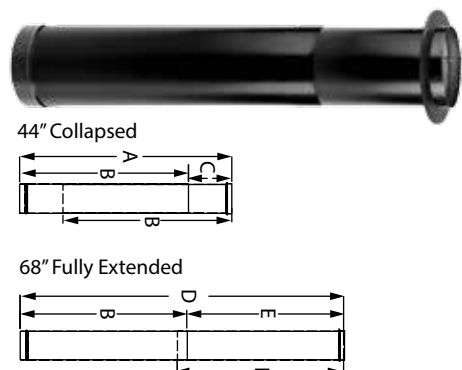

Use for a two-piece installation. Connects directly from stove to ceiling support box or finishing collar. Adjusts from 44" - 68". No cutting required. Available in stainless steel (SS).

SIZE	6"
A	44"
B	35"
C	9"
D	68"
E	33"
ORDER #	6DBK-TL
STOCK #	810000959

Snap-Lock Adapter w/ Trim

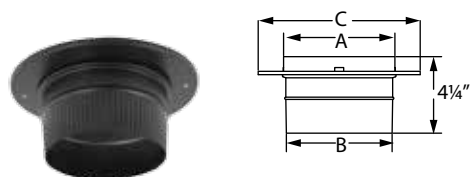

Connects into the ceiling support box or finishing collar and extends down to fit into stovepipe for a drip-free connection to a DuraTech, DuraPlus, DuraPlus HTC, or DuraLiner Chimney system. Provides a strong mechanical connection. Adapter will work with all 6" - 8" DuraPlus, 6" - 8" DuraPlus HTC, and 7" - 8" DuraTech installations. Adapter will work with 5" - 6" DuraTech Ceiling Support Box installations only.

SIZE	5"	6"	7"	8"
A	5 1/4"	6 1/4"	7 1/4"	8 1/4"
B	4 7/8"	5 7/8"	6 7/8"	7 7/8"
C	9"	9"	11"	11"
ORDER #	5DBK-ADSL	6DBK-ADSL	7DBK-ADSL	8DBK-ADSL
STOCK #	810000956	810000961	810000984	810000999

DVL/DuraBlack Chimney Adapter w/ Trim

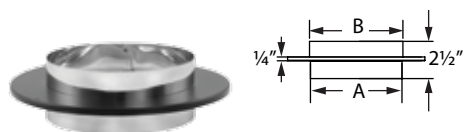

Use to connect from double-wall DVL and/or single-wall DuraBlack to DuraTech, DuraPlus, DuraPlus HTC, and DuraLiner for a through-the-wall or ceiling support installation. Required for proper connection. Made of stainless steel.

SIZE	6"	7"	8"
A	6"	7"	8"
B	6 1/8"	7 1/8"	7 1/8"
ORDER #	6DVL-ADC	7DVL-ADC	8DVL-ADC
STOCK #	810000900	810000919	810000936

DuraBlack Slip Inserter w/ Trim

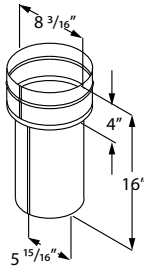

Use to adapt from 6" DuraBlack to 8" DuraTech, DuraPlus, DuraPlus HTC, or DuraLiner at the ceiling support box or finishing collar. Adds 5" - 15" of length.

SIZE	6" - 8"
ORDER #	6DBK-XS8
STOCK #	810000962

DuraBlack Single-Wall Black Pipe

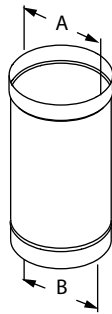

Use for a single-wall connector pipe. Requires 18" clearance to combustibles. Subtract 1 1/4" from length to calculate the installed length.

SIZE		6"	7"	8"	10"
A		6 1/8"	7 1/8"	8 1/8"	10 1/8"
B		6"	7"	8"	10"
12" LENGTH	ORDER #	6DBK-12	7DBK-12	8DBK-12	10DBK-12
	STOCK #	810000963	810000985	810001000	810001020
24" LENGTH	ORDER #	6DBK-24	7DBK-24	8DBK-24	10DBK-24
	STOCK #	810000965	810000986	810001002	810001021
48" LENGTH	ORDER #	6DBK-48	7DBK-48	8DBK-48	--
	STOCK #	810000967	810000988	810001004	--

DuraBlack Inserter

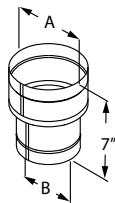

Use to increase from a smaller appliance flue outlet to a larger diameter chimney or stovepipe.

SIZE	5" - 6"	6" - 7"	7" - 8"	8" - 10"	9" - 10"
A	6 1/8"	7 1/8"	8 1/8"	10 1/8"	10 1/8"
B	5"	6"	7"	8"	9"
ORDER #	5DBK-X6	6DBK-X7	7DBK-X8	8DBK-X10	9DBK-X10
STOCK #	810000969	810000987	810001006	810001022	810001023

DuraBlack Tee w/ Clean-Out Cap

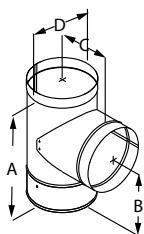

Use with rear exit appliances and appliances that require a barometric damper.

SIZE	6"	7"	8"	10"
A	10 1/2"	11 1/2"	12 1/2"	14"
B	6 3/8"	7"	7 1/4"	8 1/4"
C	5 3/4"	6"	7"	8"
D	6 1/8"	7 1/8"	8 1/8"	10 1/8"
ORDER #	6DBK-T	7DBK-T	8DBK-T	10DBK-T
STOCK #	810000970	810000991	810001007	810001024

DuraBlack 45° Elbow

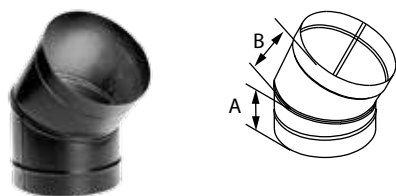

Offsets obstructions as needed. Elbows angles are now adjustable. Adjustable elbows are manufactured drip free so creosote travels back to the stove as intended.

SIZE	6"	7"	8"	10"
A	4"	4"	4 1/2"	4 1/2"
B	3 1/2"	3 3/8"	4 1/2"	3 3/8"
ORDER #	6DBK-E45	7DBK-E45	8DBK-E45	10DBK-E45
STOCK #	810000972	810000989	810001009	810001025

DuraBlack 90° Elbow

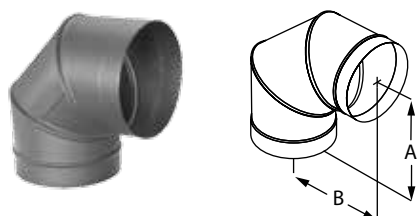

Offsets obstructions as needed or to orient the stovepipe horizontally for through the wall installation. Elbows angles are now adjustable. Adjustable elbows are manufactured drip free so creosote travels back to the stove as intended. Not recommended for rear exit appliances.

SIZE	6"	7"	8"	10"
A	6"	6 1/4"	7"	7 1/2"
B	5 3/4"	6 3/4"	7 1/8"	7"
ORDER #	6DBK-E90	7DBK-E90	8DBK-E90	10DBK-E90
STOCK #	810000974	810000990	810001011	810001026

Offset Chart - DuraBlack

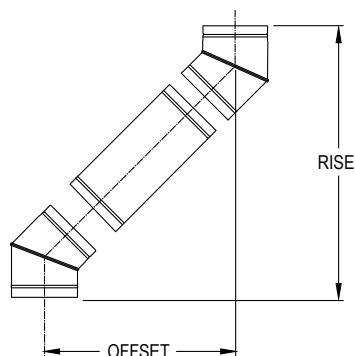

SIZE		6" DIAMETER		7" DIAMETER		8" DIAMETER		10" DIAMETER	
Elbow Degrees	Chimney Section	Offset Inches	Rise Inches	Offset Inches	Rise Inches	Offset Inches	Rise Inches	Offset Inches	Rise Inches
45°	0"	4 1/2"	12 1/2"	4 1/2"	14 3/4"	5 1/2"	14 3/4"	5 3/4"	15"
45°	12"	12"	19"	12"	22 1/4"	13 1/4"	22 1/4"	13 1/4"	22 3/4"
45°	24"	20 1/2"	28"	21 1/2"	30 3/4"	21 3/4"	30 3/4"	21 3/4"	31 1/4"
45°	48"	37 1/2"	45"	37 3/4"	47 3/4"	38 3/4"	47 3/4"	--	--
90°	0"	10 1/2"	11 3/4"	12 1/4"	12 1/2"	13"	14 1/4"	14 1/2"	16 3/4"
90°	12"	21 1/4"	11 3/4"	23"	12 1/2"	25 1/2"	14 1/4"	25 1/4"	16 3/4"
90°	24"	33 1/4"	11 3/4"	35"	12 1/2"	37 1/4"	14 1/4"	37 1/4"	16 3/4"
90°	48"	57 1/4"	11 3/4"	59"	12 1/2"	61 1/2"	14 1/4"	--	--

DuraBlack Damper Section

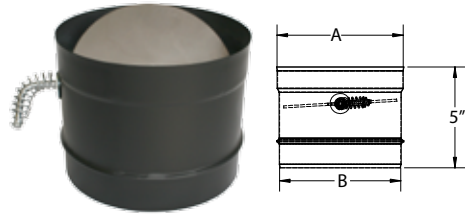

Install at, or close to, the stove outlet in-line. 5" pipe section with the damper pre-installed.

SIZE	6"	7"	8"
ORDER #	6DBK-DS	7DBK-DS	8DBK-DS
STOCK #	810000976	810000992	810001013
A	6 1/8"	7 1/8"	8 1/8"
B	6"	7"	8"

DuraBlack Oval-To-Round Adapter

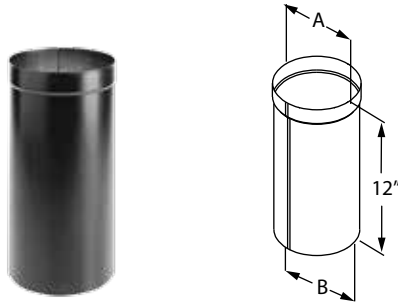

Connects to the oval flue outlet of the appliance. Must be field ovalized.

SIZE	6"	7"	8"
A	6 1/8"	7 1/8"	8 1/8"
B	5 15/16"	6 15/16"	7 15/16"
ORDER #	6DBK-ADOR	7DBK-ADOR	8DBK-ADOR
STOCK #	810000977	810000993	810001014

DuraBlack Double-Skirted Stovetop Adapter

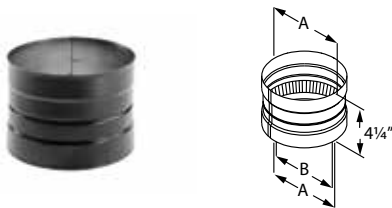

Use to adapt DuraBlack stovepipe to appliance flue outlets. Outer wall covers appliance flue outlet.

SIZE	6"	7"	8"	10"
A	6 1/8"	7 1/8"	8 1/8"	10 1/8"
B	5 5/8"	6 5/8"	7 5/8"	9 5/8"
ORDER #	6DBK-ADDB	7DBK-ADDB	8DBK-ADDB	10DBK-ADDB
STOCK #	810000978	810000994	810001015	810001027

DuraBlack Stovetop Adapter

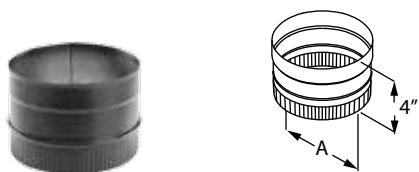

Use to adapt DuraBlack stovepipe to appliance flue outlet.

SIZE	6"	7"	8"
A	5 15/16"	6 15/16"	7 15/16"
ORDER #	6DBK-AD	7DKB-AD	8DBK-AD
STOCK #	810000979	810000995	810001016

METRIC ADAPTER 6 1/8"	
A	4 3/8"
ORDER #	6DBK-ADM
STOCK #	810000981

DuraBlack Trim Collar

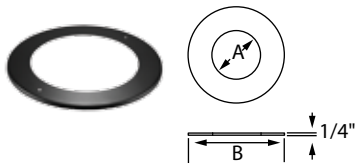

Use as a decorative Trim Collar for DuraBlack connection to chimney.

SIZE	6"	7"	8"	10"
A	6 1/8"	7 1/8"	8 1/8"	10 1/8"
B	9"	10"	11"	13"
ORDER #	6DBK-TC	7DBK-TC	8DBK-TC	10DBK-TC
STOCK #	810000982	810000996	810001018	810001028

DuraBlack Stainless Steel - Single-Wall Stovepipe

DuraBlack SS Slip Connector w/ Trim

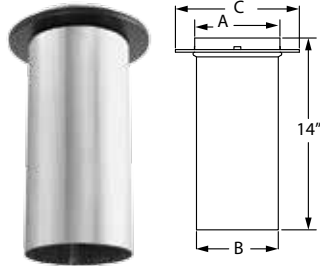

Use to adapt DuraBlack pipe to ceiling support box or finishing collar. Adds 3" - 13" of length to rigid pipe. Allows drip-free installation without cutting the pipe. Can be used in line to create a telescoping combination when used with a straight length of pipe.

SIZE	6"	8"
A	6 3/16"	8 3/16"
B	5 15/16"	7 15/16"
ORDER #	6DBK-SCSS	8DBK-SCSS
STOCK #	810000958	810000998

DuraBlack SS Telescoping Length w/ Trim

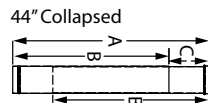

44" Collapsed

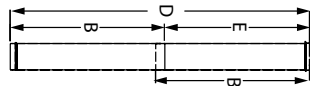

68" Fully Extended

Use for a two-piece installation. Connects directly from stove to ceiling support box or finishing collar. Adjusts from 44" - 68". No cutting required.

SIZE	6"
A	44"
B	35"
C	9"
D	68"
E	33"
ORDER #	6DBK-TLSS
STOCK #	810000960

DuraBlack SS Single-Wall Pipe

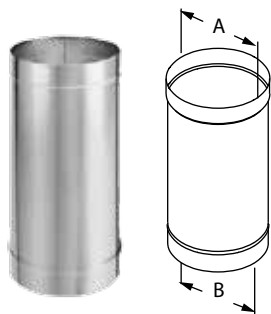

Use for a single-wall connector pipe. Requires 18" clearance to combustibles. Subtract 1 1/4" from the length to calculate the installed length.

SIZE		6"	8"
A		6 1/8"	8 1/8"
B		6"	8"
12" LENGTH	ORDER #	6DBK-12SS	8DBK-12SS
	STOCK #	810000964	810001001
24" LENGTH	ORDER #	6DBK-24SS	8DBK-24SS
	STOCK #	810000966	810001003
48" LENGTH	ORDER #	6DBK-48SS	8DBK-48SS
	STOCK #	810000968	810001005

DuraBlack SS Tee w/ Clean-Out Cap

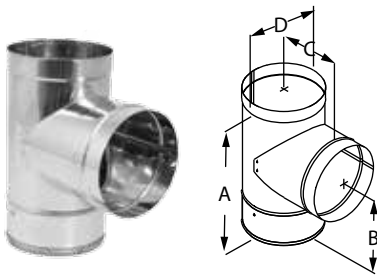

Use with rear exit appliances and appliances that require a barometric damper.

SIZE	6"	8"
A	10 1/2"	12 1/2"
B	6 3/8"	7 1/4"
C	5 3/4"	7"
D	6 1/8"	8 1/8"
ORDER #	6DBK-TSS	8DBK-TSS
STOCK #	810000971	810001008

DuraBlack SS 45° Elbow

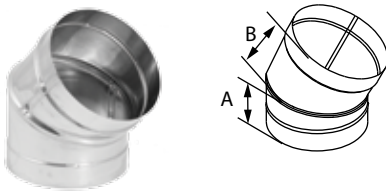

Offsets obstructions as needed. Adjustable.

SIZE	6"	8"
A	4"	4 1/2"
B	3 1/2"	4 1/2"
ORDER #	6DBK-E45SS	8DBK-E45SS
STOCK #	810000973	810001010

DuraBlack SS 90° Elbow

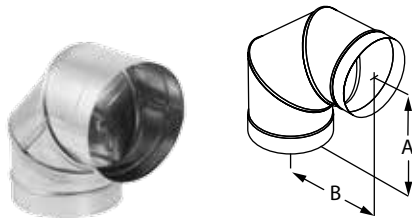

Offsets obstructions as needed. Adjustable. Not recommended for rear exit appliances.

SIZE	6"	8"
A	6"	7"
B	5 3/4"	7 1/8"
ORDER #	6DBK-E90SS	6DBK-E90SS
STOCK #	810000975	810001012

DuraBlack SS Stovetop Adapter

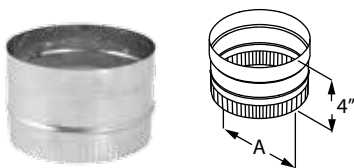

Use to adapt DuraBlack stovepipe to appliance flue outlet.

SIZE	6"	8"
A	5 15/16"	7 15/16"
ORDER #	6DBK-ADSS	8DBK-ADSS
STOCK #	810000980	810001017

DuraBlack Welded - Single-Wall Stovepipe 22 Gauge

DuraBlack Welded Slip Connector w/ Trim

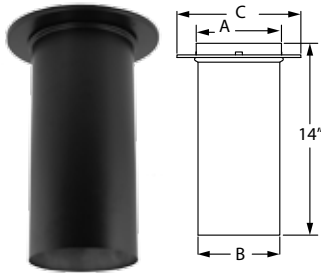

Use to adapt DuraBlack pipe to ceiling support box or finishing collar. Adds 3" - 13" of length to rigid pipe. Allows drip-free installation without cutting the pipe. Can be used in line to create a telescoping combination when used with a straight length of pipe. Requires screws.

SIZE	6"
A	6 3/16"
B	5 15/16"
ORDER #	6DBK-SCW
STOCK #	810008023

DuraBlack Welded Telescoping Length w/ Trim

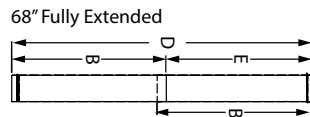
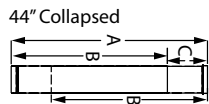

Use for a two-piece installation. Connects directly from stove to ceiling support box or finishing collar. Adjusts from 44" - 68". No cutting required. Available in stainless steel (SS).

SIZE	6"
A	44"
B	35"
C	9"
D	68"
E	33"
ORDER #	6DBK-TLW
STOCK #	81000804

DuraBlack Welded Single-Wall Black Pipe

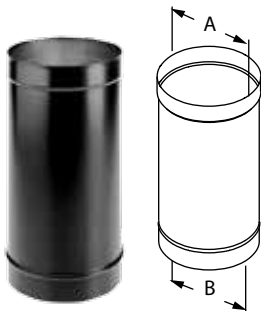

Use for a single-wall connector pipe. Requires 18" clearance to combustibles. Subtract 1 1/4" from length to calculate the installed length.

SIZE	6"	
A	6 1/8"	
B	6"	
12" LENGTH	ORDER #	6DBK-12W
	STOCK #	810008016
24" LENGTH	ORDER #	6DBK-24W
	STOCK #	810008017
48" LENGTH	ORDER #	6DBK-48W
	STOCK #	810008018

DuraBlack Welded Tee w/
Clean-Out Cap

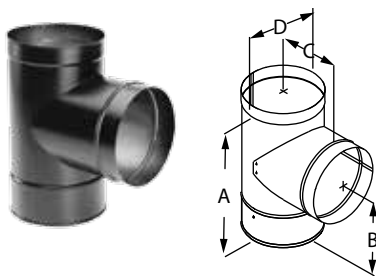

Use with rear exit appliances and appliances that require a barometric damper.

SIZE	6"
A	10 1/2"
B	6 3/8"
C	5 3/4"
D	6 1/8"
ORDER #	6DBK-TW
STOCK #	810008025

DuraBlack Welded 45° Elbow

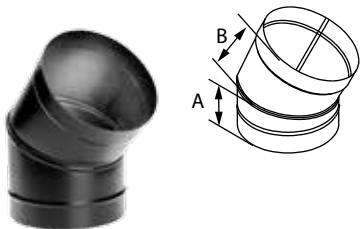

Offsets obstructions as needed. Adjustable.

SIZE	6"
A	4"
B	3 1/2"
ORDER #	6DBK-E45W
STOCK #	810008021

DuraBlack Welded 90° Elbow

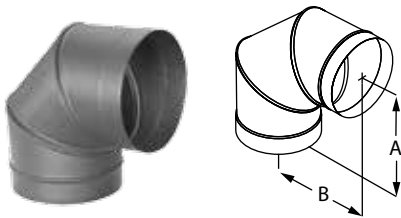

Offsets obstructions as needed. Adjustable. Not recommended for rear exit appliances.

SIZE	6"
A	6"
B	5 3/4"
ORDER #	6DBK-E90W
STOCK #	810008022

DuraBlack Welded Damper Section

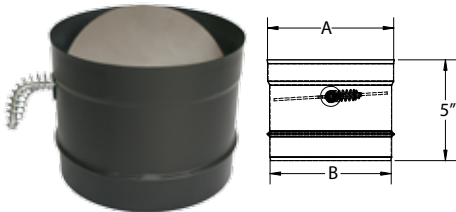

Install at, or close to, the stove outlet in-line. 5" pipe section with the damper pre-installed.

SIZE	6"
A	6 1/8"
B	6"
ORDER #	6DBK-DSW
STOCK #	810008020

DuraBlack Welded Stovetop Adapter

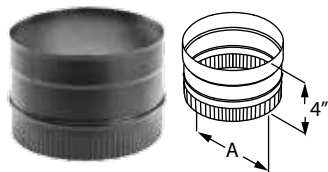

Use to adapt DuraBlack stovepipe to appliance flue outlet.

SIZE	6"
A	5 15/16"
ORDER #	6DBK-ADW
STOCK #	810008019