



# PELLETVENT PRO® PELLET & CORN VENT SYSTEM

VENTING PRODUCTS FOR STOVES FUELED BY PELLET OR CORN



## ENGINEERED EXCELLENCE®

PelletVent Pro is a new, patent-pending product, for venting both pellet- and corn-burning stoves and inserts. As a result of Simpson Dura-Vent's cutting-edge manufacturing process and commitment to innovation, PelletVent Pro is uncompromising in attention to detail and performance.

Since the introduction of pellet stoves in 1984, Simpson Dura-Vent has been recognized as the industry leader in venting systems for pellet stoves. Today, approximately 3 out of every 4 pellet stoves in the US and Canada are vented with a Simpson Dura-Vent pellet system.

## INNOVATION, NOT IMITATION

Simpson Dura-Vent has again set a new benchmark with PelletVent Pro. No gaskets or sealants are required to achieve leak-resistant connections. This perfect fit and finish is made possible with laser-welded 304 stainless steel inner walls and galvalume outer walls. The double-wall system provides superior heat and corrosion resistance for safe, long-lasting performance. The result is a clean, streamlined appearance when installed. The precise fit of the twist-lock connection is fast, safe, and secure.

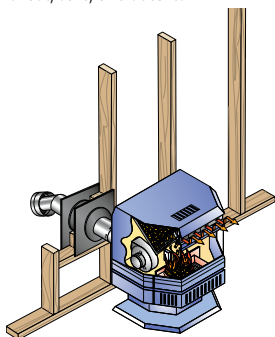

## EASE OF INSTALLATION

With only a 1" clearance to combustibles required for PelletVent Pro venting products,\* more options for installation, in a variety of situations, are possible. In fact, it is the only L Vent UL listed for 1" clearance to combustibles in the USA.

PelletVent Pro elbows swivel 360° at the connection, allowing accurate positioning by bringing the installation to plumb. Rotates as needed to get the job done much more precisely. Tee branches swivel for easy alignment and access for cleaning the vent.

A wide range of components are available to make your pellet chimney system safe, convenient, and efficient. Select components are available in black. PelletVent Pro is tested and listed to the ULC S609 and ULC/ORD-C441 standards, file #CMH1439 and #CMH1440.

## APPLICATIONS

The PelletVent Pro system, offered in 3" and 4" diameters, is designed for use with pellet stoves, low-temperature venting systems, and it is also designed to withstand corrosive flue gasses of corn-burning appliances. PelletVent Pro is rated for continuous flue temperatures up to, but not exceeding, 570°. PelletVent Pro is not interchangeable with standard PelletVent or CornVent.

\* In Canada, a 3" clearance to combustibles is required for pellet- and corn-burning appliances.

Limited Lifetime warranty.



## DESIGNED FOR PROFESSIONALS

Simpson Dura-Vent designed PelletVent Pro with the installer in mind. The precise fit of the twist-lock connection is fast, secure, and leak-resistant without the use of gaskets or sealants.

- No gaskets or sealants required.
- 1" clearance to nearby combustibles\*.
- The perfect fit and finish results in a clean, streamlined appearance.
- One product for both pellet- and corn-burning appliances.
- Laser-welded seams.
- Select components also available in black.
- Swivel Elbow connections.

## LISTED BY UNDERWRITERS LABORATORIES

- PelletVent Pro is approved by UL and ULC.
- Tested and listed to UL 641 Standard, file #MH8381 and #MH14420.
- Tested and listed to the ULC S609 and ULC/ORD-C441 standards, file #CMH1439 and #CMH1440.

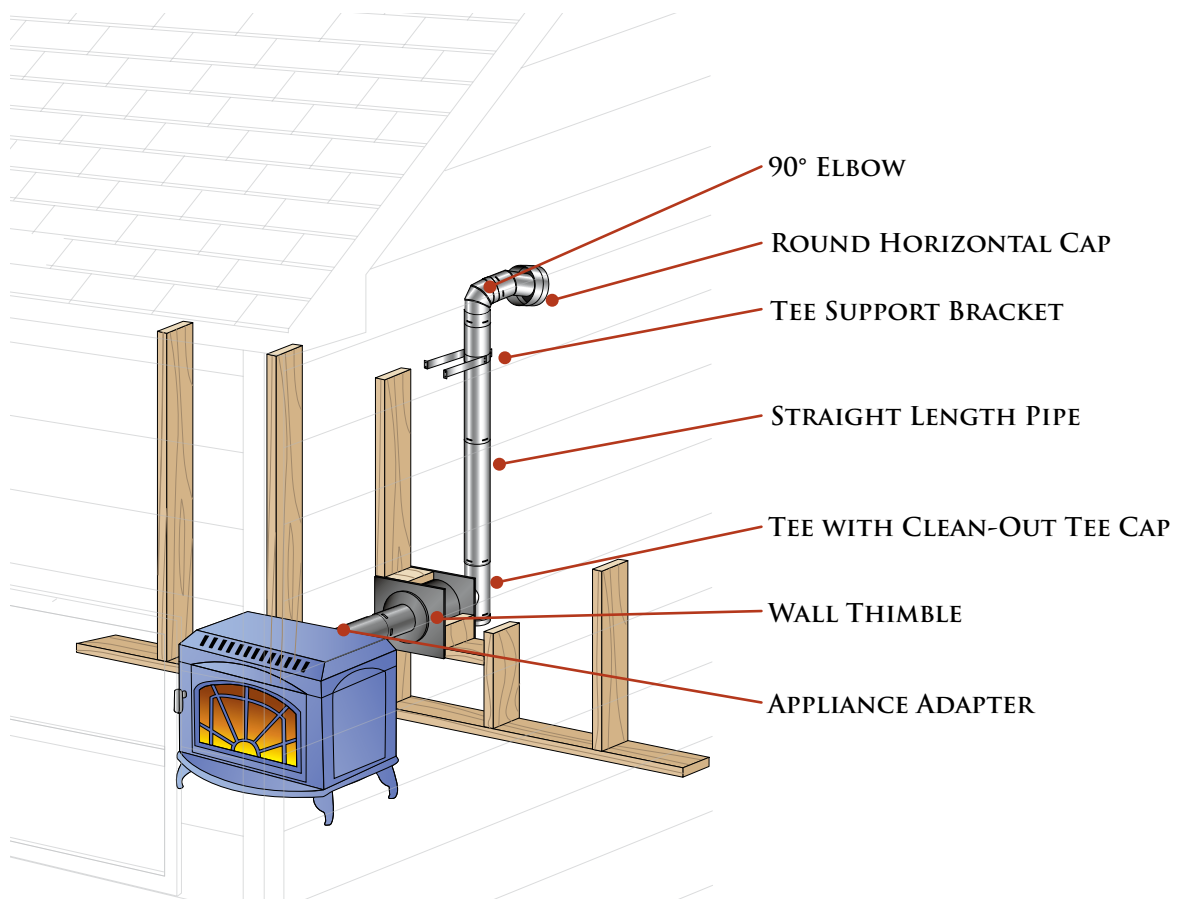

| ILLUSTRATION KEY |                                 |
|------------------|---------------------------------|
| 1                | Vertical Cap                    |
| 2                | Storm Collar                    |
| 3                | Flashing                        |
| 4                | Cathedral Ceiling Support Box   |
| 5                | Straight Length Pipe            |
| 6                | 45° Elbow                       |
| 7                | Appliance Adapter               |
| 8                | 60" Flexible Length             |
| 9                | 90° Elbow                       |
| 10               | Round Horizontal Cap            |
| 11               | Wall Thimble                    |
| 12               | Ceiling Support Firestop Spacer |
| 13               | Tee w/Clean-Out Tee Cap         |
| 14               | Wall Strap                      |
| 15               | Attic Insulation Shield         |

### Typical Installations

- Refer to our Typical Venting Installation drawings to select the appropriate component parts for your installation.
- The inner pipe diameter should match the outlet size of the appliance.
- Check the appliance manufacturer's installation instructions to confirm which types of vent configurations are permitted (i.e. horizontal, vertical, chimney reline, etc.). Also, check for any venting restrictions such as maximum horizontal run, minimum and maximum vertical rise, maximum offset, etc.
- Be fire-safe! Maintain the minimum clearances (air-space) between the vent pipe and nearby combustibles, as specified in the appliance manufacturer's installation instructions. Use proper support and bracing. Follow local building codes and have your venting system inspected.

### PELLET INSERT

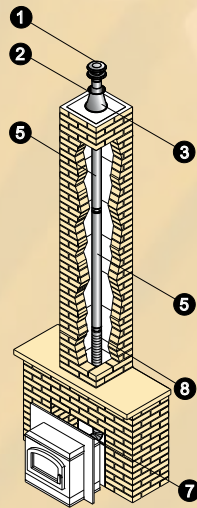

### CATHEDRAL CEILING (STOVE INSTALLATION)

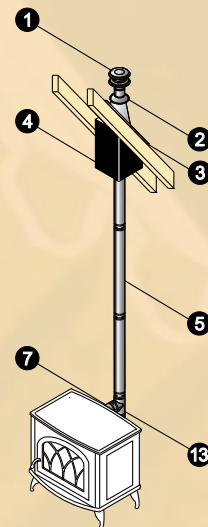

### THROUGH-THE-WALL

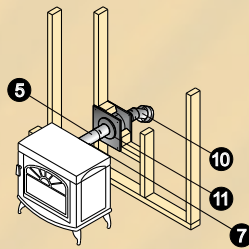

### THROUGH-THE-WALL (VERTICAL RISE)

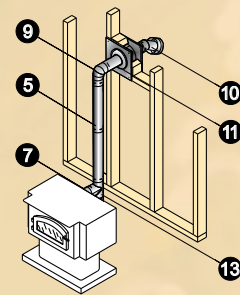

### MASONRY CHIMNEY RELINING

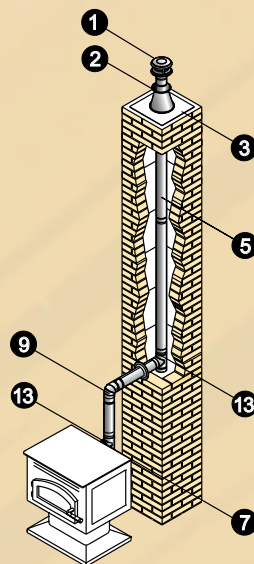

### ATTIC OFFSET

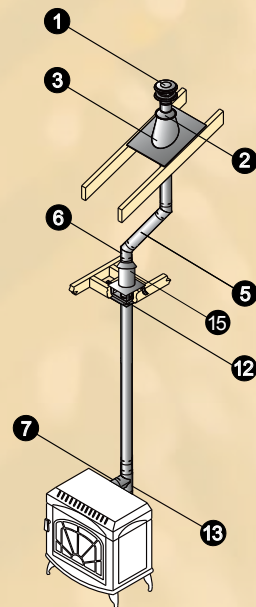

## HOW TO PLAN YOUR CHIMNEY INSTALLATION

|         |  |
|---------|--|
| Step 1. | Refer to the Typical PelletVent Pro Installations diagram, on the opposite page, to be familiar with some of the standard PelletVent Pro installations and the required component parts.   |
| Step 2. | For a horizontal termination, you will need a Wall Thimble and a Round Horizontal Cap. The cap must be installed with a 6" clearance to the outside wall and a 12" clearance off the ground.   |
| Step 3. | For a vertical termination, you will need a Cathedral Ceiling Support Box or a Flat Ceiling Support, a Flashing, a Storm Collar, and a Vertical Cap.   |
| Step 4. | Determine the length of PelletVent Pro pipe required. For a vertical termination, measure the pitch of the roof and select the proper flashing. The required minimum height above the roof is 12".   |
| Step 5. | Pellet stove inserts in masonry fireplaces will require a flex pipe to snake the vent past the smoke shelf. For transition from PelletVent Pro to an existing DuraPlus, DuraPlus HTC, or DuraTech Chimney, a Chimney Adapter is available. |
| Step 6. | For vertical rise of PelletVent Pro on the outside of the house, Wall Straps should be used at 4' intervals to provide proper support.   |
| Step 7. | Important! Check to be sure that the appliance and the venting system are in compliance with all minimum clearance to combustible requirements.  |

## CHIMNEY DESIGN RECOMMENDATIONS

The following design recommendations are intended only as a general guideline to assist in the design and selection of venting components for your installation. Read and follow the PelletVent Pro installation instructions before installing your venting system.

- Size the vent to meet the appliance manufacturer's specifications.
- Avoid long runs and excessive use of elbows. Refer to the appliance manufacturer for minimum rise and maximum run configurations for the venting system.
- Use a Appliance Adapter to ensure a proper connection to the appliance.
- Use a Single or Double Tee with Clean-Out Tee Cap to facilitate easy cleaning. Do not use a 90° elbow off the back of the appliance, unless authorized by the appliance manufacturer.
- Maintain the minimum 1" clearance\* (air space) from vent pipe to combustibles. Use proper support and bracing. Follow local building codes and have your venting system inspected. Be fire-safe!

\* In Canada, a 3" clearance is required to combustibles for pellet- and corn-burning appliances.

