

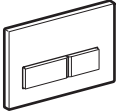
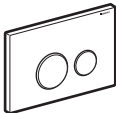
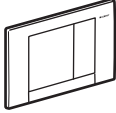
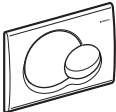

Flush Plate Actuators

Dual-Flush Actuator Plates for 111.335.00.X Toilet Carrier (UP320, UP300 flush tanks)

Style	Material	Finish	Model No.	List Price
Sigma50 	Zinc die cast	Customer defined	115.788.00.1	\$300.00
		Alpine White	115.788.11.1	300.00
		Black	115.788.DW.1	300.00
		Pergamon	115.788.EP.1	300.00
		White Pattern Glass	115.788.SC.1	386.00
		Smoke Glass	115.788.SD.1	386.00
		Green Satin Glass	115.788.SE.1	386.00
Sigma20 	Plastic	Gloss-Matte-Gloss*	115.778.KH.1	149.00
		White-Gloss-White*	115.778.KJ.1	104.00
		White-Gold-White*	115.778.KK.1	480.00
		White-Matte-Matte*	115.778.KL.1	128.00
		Black-Gloss-Black*	115.778.KM.1	128.00
		Matte-Gloss-Matte*	115.778.KN.1	149.00
		Bolero 	Plastic	Alpine White
Polished Chrome	115.777.21.1	128.00		
Matte Chrome	115.777.46.1	128.00		
Pergamon	115.777.EP.1	99.00		
Satinox	115.777.GM.1	300.00		
Samba 	Plastic	Alpine White	115.770.11.1	73.00
		Polished Chrome	115.770.21.1	99.00
		Matte Chrome	115.770.46.1	99.00
		Pergamon	115.770.EP.1	73.00
		Satinox	115.770.GM.1	300.00

Dual-Flush Actuator Plates for 111.255.00.1 Toilet Carrier (UP200 flush tank)

Kappa50 	Stainless Steel	Brushed SS	115.258.00.1	202.00
	Zinc die cast	Alpine White	115.260.11.1	202.00
		Polished Chrome	115.260.21.1	202.00
		Matte Chrome	115.260.46.1	202.00
		Palladium Matte	115.260.HC.1	480.00
Kappa20 	Plastic	Alpine White	115.228.11.1	83.00
		Polished Chrome	115.228.21.1	113.00
		Matte Chrome	115.228.46.1	113.00
		Pergamon	115.228.EP.1	83.00
		Satinox	115.228.GM.1	300.00

Single-Flush Actuator Plates for 111.335.00.X Toilet Carrier (UP320, UP300 flush tanks)

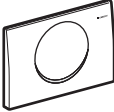
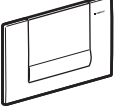
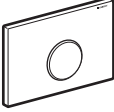
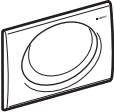
Style	Material	Finish	Model No.	List Price
Mambo 	Stainless Steel	Brushed SS	115.751.00.1	\$202.00
Tango 	Zinc die cast	Alpine White	115.760.11.1	202.00
		Polished Chrome	115.760.21.1	202.00
		Matte Chrome	115.760.46.1	202.00
		Pergamon	115.760.EP.1	202.00
		ForeverShine™	115.760.GG.1	350.00
		PVD Bright Brass		
		Satinox	115.760.GM.1	300.00
		Palladium Matte	115.760.HC.1	480.00
		Oil Rubbed Bronze	115.760.HM.1	350.00
		ForeverShine™	115.760.IB.1	350.00
PVD Polished Nickel				
ForeverShine™	115.760.ID.1	350.00		
PVD Brushed Nickel				
Gloss-Matte**	115.760.KA.1	202.00		
Sigma10 	Plastic	Gloss-Matte-Gloss*	115.758.KH.1	149.00
		White-Gloss-White*	115.758.KJ.1	104.00
		White-Gold-White*	115.758.KK.1	300.00
		White-Matte-Matte*	115.758.KL.1	128.00
		Black-Gloss-Black*	115.758.KM.1	128.00
		Matte-Gloss-Matte*	115.758.KN.1	149.00
		Rumba 	Plastic	Alpine White
Polished Chrome	115.750.21.1	99.00		
Matte Chrome	115.750.46.1	99.00		
Pergamon	115.750.EP.1	73.00		
Satinox	115.750.GM.1	300.00		

Dimensions Information

Dual-Flush	Sigma50	9.69" (24.6 cm) x 6.46" (16.4 cm)
	Sigma20	
	Bolero	
	Samba	
	Kappa50	
Single-Flush	Mambo	9.69" (24.6 cm) x 6.46" (16.4 cm)
	Tango	
	Sigma10	
Rumba		

* Colors follow this pattern = Plate/Ring/Button

**Colors follow this pattern = Frame/Button

Gloss = Polished Chrome
Matte = Matte Chrome

Replacement Parts for Bolero and Samba Actuators

115.770



115.777



Item No.		Model No.	Description	List Price
1	1	240.935.00.1	Mounting Frame	\$30.00
2	2	241.875.00.1	Actuator bolt and rod kit	12.00
3	3	240.938.00.1	Extension set for actuator plates compatible with UP320, UP300, UP200	19.00
4		813.514.00.1	Spring for actuator plate	2.00
	5	241.295.00.1	Spring for actuator plate, 10 pcs	9.00
6	6	241.873.00.1	Conversion kit for tool-free assembly (converts units manufactured prior to 04.01.2008)	26.00
6.1	6.1	241.874.00.1	Actuator bolt and rod kit, Tool-free assembly	11.00
6.2	6.2	241.876.00.1	Mounting Frame, Tool-free assembly	12.00

115.770

115.777

Through 04.2008

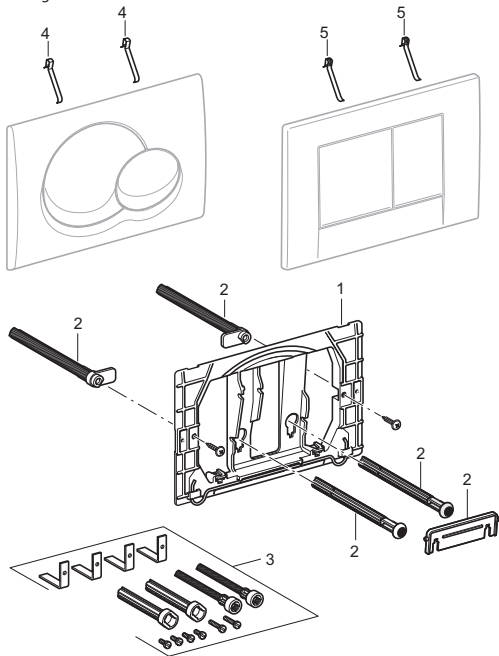

After 04.2008

