

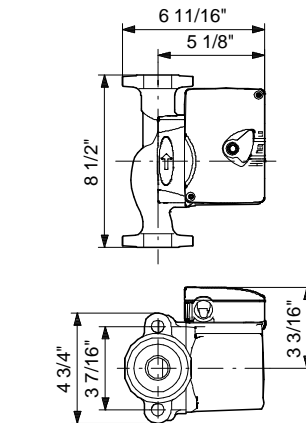

Position	Count	Description	Unit price
	-1	<p>UPS 43-44 BFC</p>  <p>Product photo could vary from the actual product</p> <p>Product No.: 52722521 The pump is of the canned rotor type, i.e. pump and motor form an integral unit without shaft seal and with only two gaskets for sealing. The bearings are lubricated by the pumped liquid. The pump is characterized by:</p> <ul style="list-style-type: none"> * Ceramic shaft and radial bearings. * Carbon axial bearing. * Stainless steel rotor can and bearing plate. * Corrosion-resistant impeller, Composite, PES. * Bronze pump housing. <p>The motor is a 1-phase motor. No additional motor protection is required.</p> <p>Liquid: Liquid temperature range: 35.6 .. 230 °F Density: 62.4 lb/ft³</p> <p>Technical: Maximum operating pressure: 145 psi Approvals on nameplate: UL, CSA</p> <p>Materials: Pump housing: Bronze DIN W.-Nr. 2.1176.01 Impeller: Composite, PES</p> <p>Installation: Maximum ambient temperature: 104 °F Ambient max at 176°F liquid: 176 °F Maximum operating pressure: 145 psi Flange standard: USA Oval Type of connection: Bronze Flange Pipe connection: 2 - Bolt Flange Pressure stage: 10 Port-to-port length: 8 1/2 in</p> <p>Electrical data:</p>	On request

Position	Count	Description	Unit price
		Number of poles: 2 Power input in speed 1: 157 W Power input in speed 2: 190 W Max. power input: 203 W Rated power - P2: 0.161 HP Main frequency: 60 Hz Rated voltage: 1 x 230 V Current in speed 1: 0.7 A Current in speed 2: 0.8 A Current in speed 3: 0.9 A Capacitor size - run: 5 µF/400 V Insulation class (IEC 85): F Others: Gross weight: 13.5 lb	

Description	Value
Product name:	UPS 43-44 BFC
Product Number:	52722521
EAN number:	5700834891069
Technical:	
Speed Number:	3
Max flow:	63 US gpm
Head max:	14.1 ft
Maximum operating pressure:	145 psi
Approvals on nameplate:	UL, CSA
Valve:	pump with built-in isolating and non-return valves
Materials:	
Pump housing:	Bronze
	DIN W.-Nr. 2.1176.01
Impeller:	Composite, PES
Installation:	
Maximum ambient temperature:	104 °F
Ambient max at 176°F liquid:	176 °F
Maximum operating pressure:	145 psi
Flange standard:	USA Oval
Type of connection:	Bronze Flange
Pipe connection:	2 - Bolt Flange
Pressure stage:	10
Port-to-port length:	8 1/2 in
Liquid:	
Liquid temperature range:	35.6 .. 230 °F
Density:	62.4 lb/ft³
Electrical data:	
Number of poles:	2
Power input in speed 1:	157 W
Power input in speed 2:	190 W
Max. power input:	203 W
Rated power - P2:	0.161 HP
Main frequency:	60 Hz
Rated voltage:	1 x 230 V
Current in speed 1:	0.7 A
Current in speed 2:	0.8 A
Current in speed 3:	0.9 A
Capacitor size - run:	5 µF/400 V
Insulation class (IEC 85):	F
Motor protection:	CONTACT
Thermal protec:	internal
Controls:	
Pos term box:	9H
Others:	
Gross weight:	13.5 lb

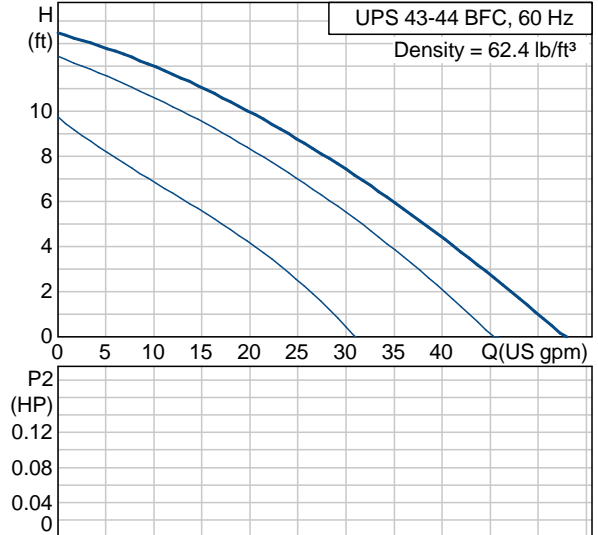

52722521 UPS 43-44 BFC 60 Hz

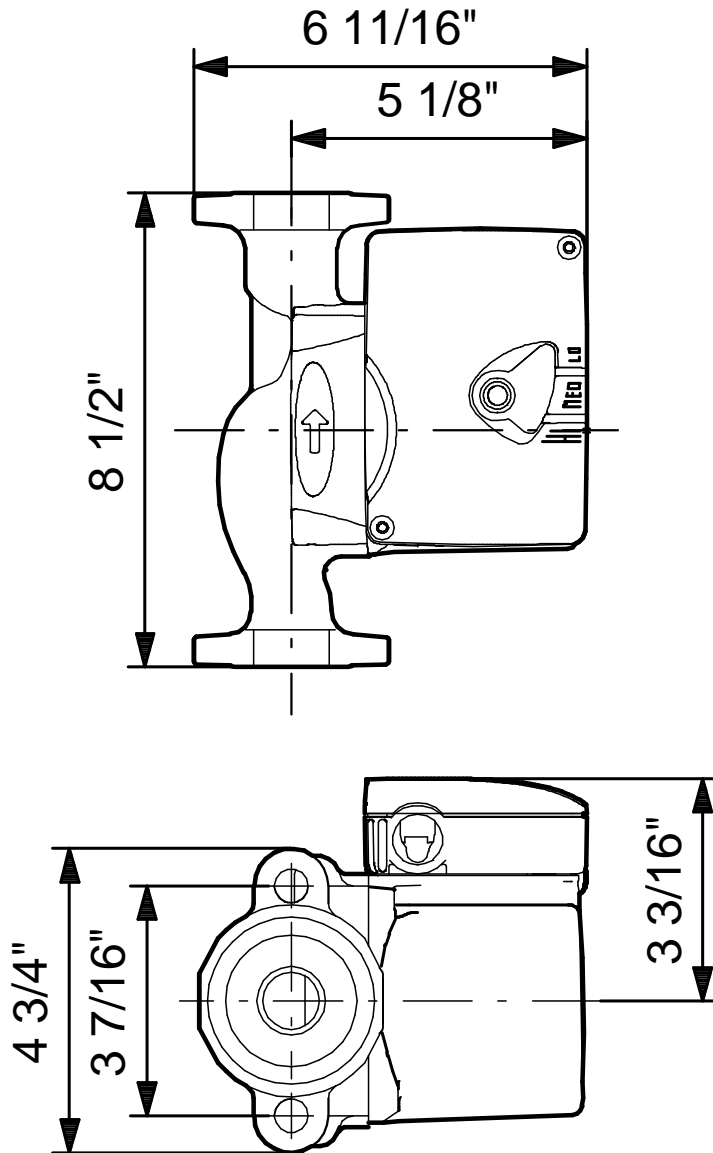

Note! All units are in [mm] unless others are stated.
Disclaimer: This simplified dimensional drawing does not show all details.