



Position	Count	Description	Unit price
	-1	<p>UP 15-42 B7</p>  <p>Product photo could vary from the actual product</p> <p>Product No.: 59896149 The pump is of the canned rotor type, i.e. pump and motor form an integral unit without shaft seal and with only two gaskets for sealing. The bearings are lubricated by the pumped liquid. The pump is characterized by:</p> <ul style="list-style-type: none"> * Ceramic shaft and radial bearings. * Carbon axial bearing. * Stainless steel rotor can and bearing plate. * Corrosion-resistant impeller, Composite, PES. * Bronze pump housing. <p>The motor is a 1-phase motor. No additional motor protection is required.</p> <p>Liquid: Liquid temperature range: 35.6 .. 230 °F Density: 62.4 lb/ft³</p> <p>Technical: Maximum operating pressure: 145 psi Approvals on nameplate: UL, CSA</p> <p>Materials: Pump housing: Bronze DIN W.-Nr. 2.1176.01 Impeller: Composite, PES</p> <p>Installation: Maximum ambient temperature: 104 °F Ambient max at 176°F liquid: 176 °F Maximum operating pressure: 145 psi Flange standard: USA Sweat Type of connection: Bronze Sweat Pipe connection: 3/4" Sweat Pressure stage: 10 Port-to-port length: 6 3/8 in</p> <p>Electrical data:</p>	On request



Company name: -
Created by: -
Phone: -
Fax: -
Date: -

Position	Count	Description	Unit price
		Number of poles: 2 Max. power input: 95 W Rated power - P2: 0.04 HP Main frequency: 60 Hz Rated voltage: 1 x 230 V Current in speed 3: 0.41 A Capacitor size - run: 2 µF/400 V Insulation class (IEC 85): F	
		Others: Gross weight: 6.7 lb	

Description	Value
Product name:	UP 15-42 B7
Product Number:	59896149
EAN number:	5700391412622
Technical:	
Speed Number:	1
Max flow:	17.2 US gpm
Head max:	15.1 ft
Maximum operating pressure:	145 psi
Approvals on nameplate:	UL, CSA
Materials:	
Pump housing:	Bronze
	DIN W.-Nr. 2.1176.01
Impeller:	Composite, PES
Installation:	
Maximum ambient temperature:	104 °F
Ambient max at 176°F liquid:	176 °F
Maximum operating pressure:	145 psi
Flange standard:	USA Sweat
Type of connection:	Bronze Sweat
Pipe connection:	3/4" Sweat
Pressure stage:	10
Port-to-port length:	6 3/8 in
Liquid:	
Liquid temperature range:	35.6 .. 230 °F
Density:	62.4 lb/ft³
Electrical data:	
Number of poles:	2
Max. power input:	95 W
Rated power - P2:	0.04 HP
Main frequency:	60 Hz
Rated voltage:	1 x 230 V
Current in speed 3:	0.41 A
Capacitor size - run:	2 µF/400 V
Insulation class (IEC 85):	F
Motor protection:	CONTACT
Thermal protec:	internal
Controls:	
Pos term box:	9H
Others:	
Gross weight:	6.7 lb

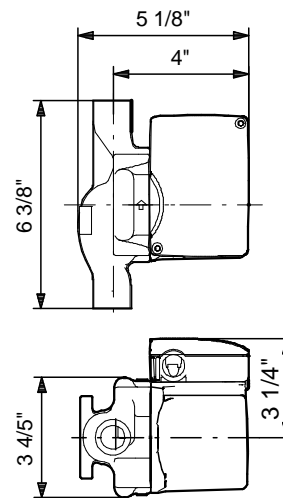
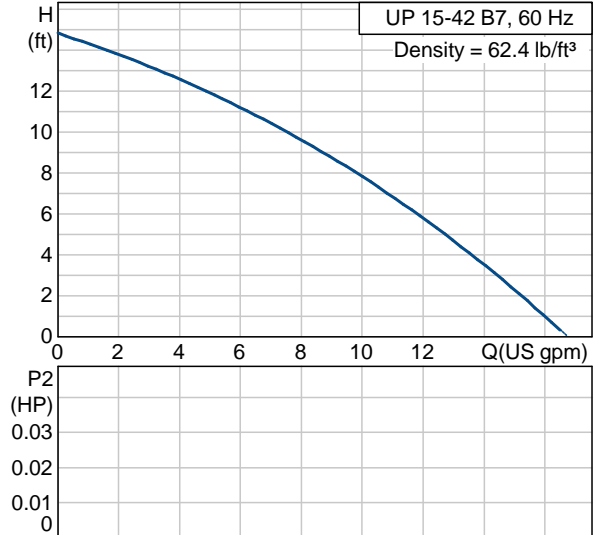

59896149 UP 15-42 B7 60 Hz

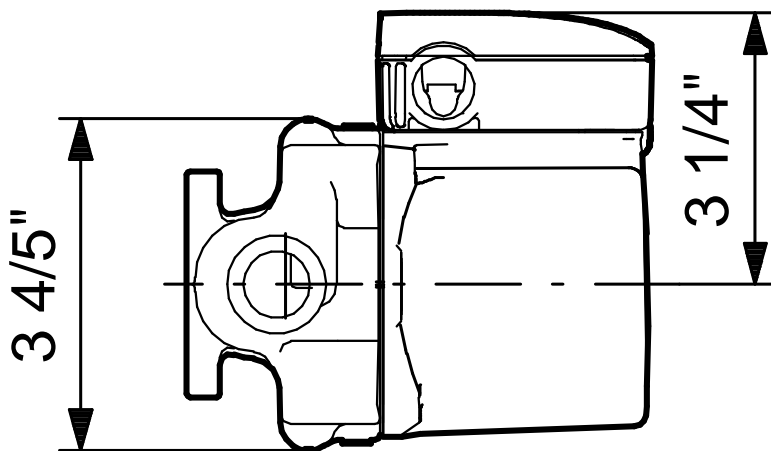
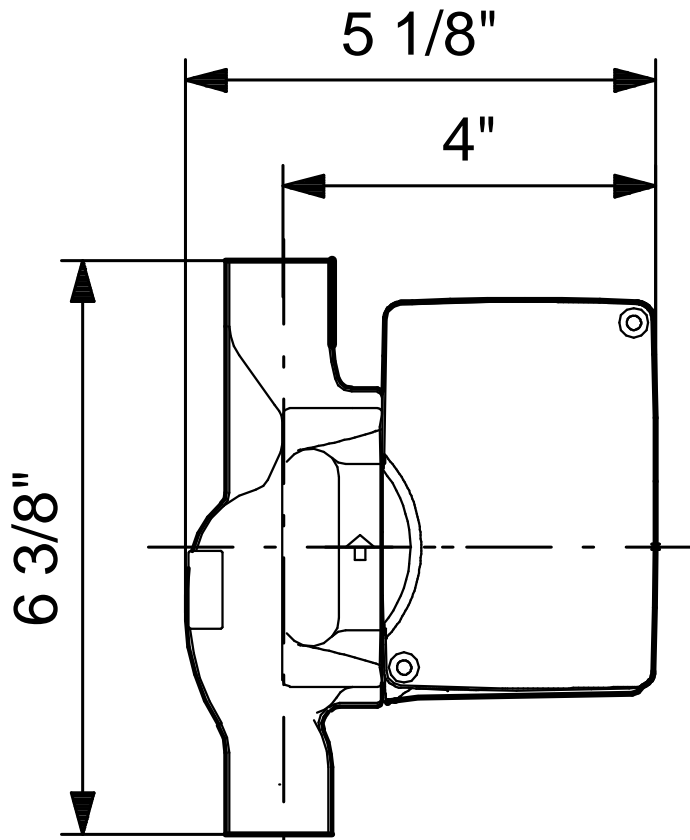

Note! All units are in [mm] unless others are stated.
Disclaimer: This simplified dimensional drawing does not show all details.