

146-119

EcoQuantum®

Round Front, Vitreous China, Two-Piece Toilet



Features

- High performance, high efficiency (HET), pressure-assist, dual flush technology
- “Dual action” trip lever
 - Push down for high efficiency flush 1.1 gpf / 4.0 lpf
 - Pull up for full flush 1.6 gpf / 6.0 lpf
- SAVES up to 40% more water than conventional 1.6 gpf flushing systems
- Round front bowl
- 12" rough-in
- 2-1/8" glazed trapway
- Model 50 and Model 50RH chrome-plated metal trip lever
- The Mansfield® limited lifetime warranty
- Available in White and Standard Colors: Biscuit, Bone





Round Front



Model 146-119
Toilet seat not included

Components

Model #	Description	Codes/Standards
146-119	Round front, dual flush, two-piece, pressure-assist toilet. Less toilet seat and supply. Specify color.	  
146	Round front, toilet bowl only. Less toilet seat. Specify color.	
119	Dual Flush, pressure-assist tank and cover only with left hand, chrome-plated metal trip lever. Less supply. Specify color.	
119RH	Same as model 119, except with right hand chrome-plated, metal trip lever.	
119CL	Same as model 119, except with cover lock.	



MADE IN USA



146-119

EcoQuantum®

Round Front, Vitreous China, Two-Piece Toilet



Specifications

Model #	Description	Codes/Standards
146-119	Round front, dual flush (1.1 or 1.6 gpf) two-piece toilet	  

Specification	Description	Specification	Description
Material	Vitreous China	Trap Diameter	2-1/8"
Water Pressure Range	35 to 80 PSI	Trap Seal	2-1/8"
Flush System	Pressure Assist Vessel with Dual Flush Technology	Rough-in	12"
Water Usage	1.1 gpf / 4.0 lpf or 1.6 gpf / 6.0 lpf	Shipping Weight	Model 146 - 51 lbs. (23 kg) Model 119/119RH/119CL - 42 lbs. (19 kg)
Water Surface Area	10" X 12"	Warranty	Vitreous China - Limited Lifetime Tank Trim - Limited One Year
MaP Rating	1000 grams		

Technical Information

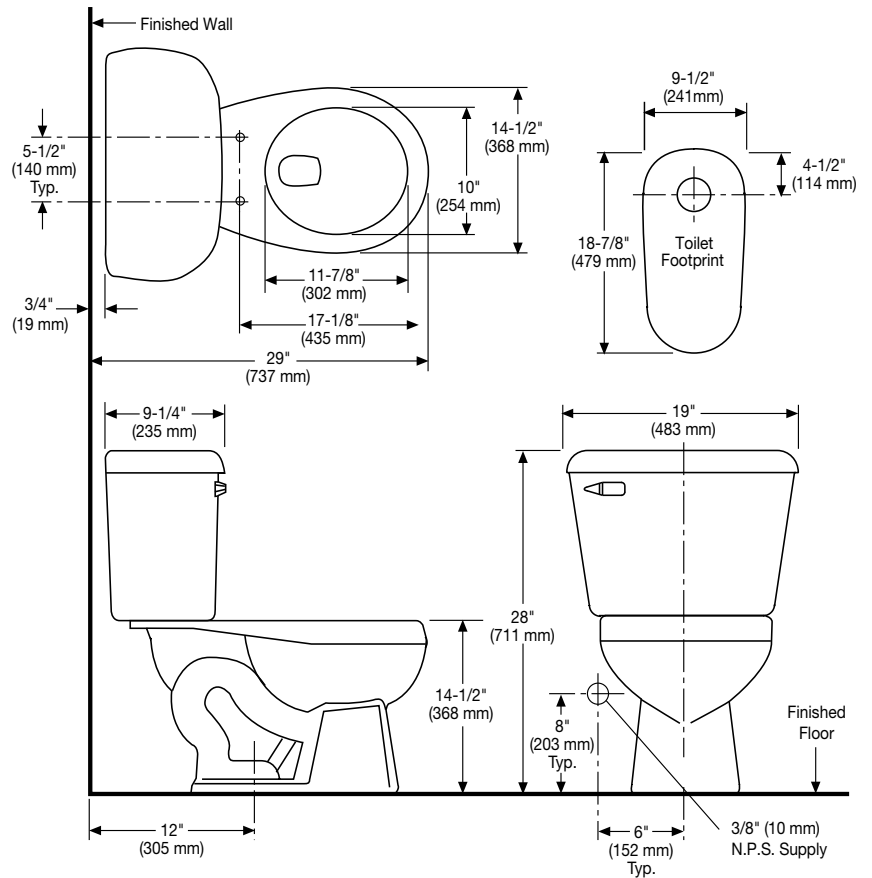

See our complete line of acrylic and vitreous china bathroom fixtures, plastic tank trim and plumbing products.

These dimensions are nominal and subject to change without notice.

Fixture performance and specifications meet or exceed ASME A112.19.2-2008/CSA B45.1-08 standards, and other state and local codes.



MADE IN USA