

388-387

Summit™ RD SmartHeight™ 1.28

Round Front, SmartHeight™, Vitreous China, Two-Piece Toilet



Features

- Round front, 16-3/4" SmartHeight™ bowl
- 1.28 Gpf / 4.86 Lpf
- 3 bolt tank-to-bowl connection
- High performance MagnaFlush™ flushing technology
- 3" flush valve
- Pilot operated anti-siphon fill valve
- 12" rough-in
- Front-mount, chrome-plated, metal trip lever
- 2" glazed trapway
- The Mansfield® limited lifetime warranty
- Available in white and standard colors: biscuit and bone





Model 388-387
Toilet seat not included



*Also available as a complete toilet package.

Components

Model #	Description	Codes/Standards
388-387	Round front, SmartHeight™ two-piece toilet. Less toilet seat and supply. Specify color.	  
388	Round front, SmartHeight™ toilet bowl only. Less toilet seat. Specify color.	
387	Tank and cover only with left hand, front-mount, chrome-plated, metal trip lever. Less supply. Specify color.	
387RH	Same as above, with right hand trip lever.	
*4388CTK	Round front, SmartHeight™ complete toilet kit. Includes toilet seat, tank and bowl, flange bolts, wax ring with polyethylene flange and instructions.	



MADE IN USA



388-387

Summit™ RD SmartHeight™ 1.28

Round Front, SmartHeight™, Vitreous China, Two-Piece Toilet



Specifications

Model #	Description	Codes/Standards
388-387	Round front, SmartHeight™ (1.28 Gpf / 4.86 Lpf) two-piece, toilet.	  

Specification	Description	Specification	Description
Material	Vitreous china	Trap Diameter	2"
Water Pressure Range	20 to 80 PSI	Trap Seal	2-1/4"
MaP Rating	800 grams	Rough-in	12"
Water Usage	1.28 Gpf / 4.86 Lpf	Shipping Weight	Model 388 - 57 lbs.; Model 387 - 34 lbs.; Model 4388CTK - 94 lbs.
Water Surface Area	8" X 9"	Warranty	Vitreous China - Limited Lifetime Tank Trim - Limited One Year
Flush System	3" flush valve - MagnaFlush™ Flushing Technology		

Technical Information

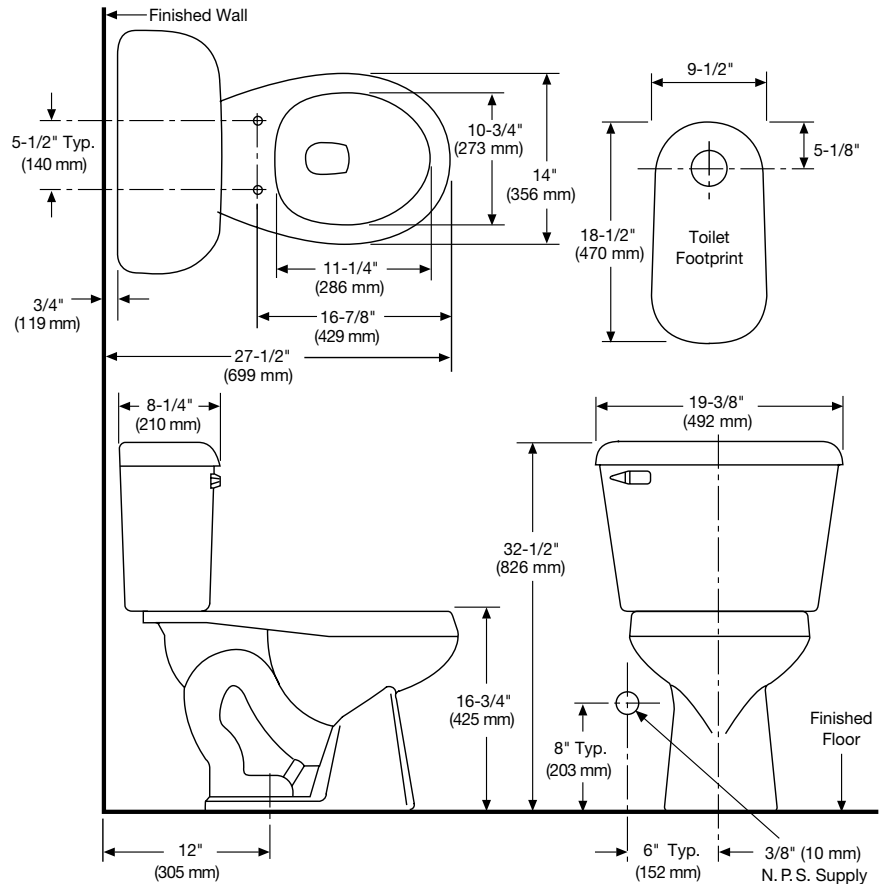

See our complete line of acrylic and vitreous china bathroom fixtures, plastic tank trim and plumbing products.

These dimensions are nominal and subject to change without notice.

Fixture performance and specifications meet or exceed ASME A112.19.2-2008/CSA B45.1-08 standards, and other state and local codes.



MADE IN USA