

Installation Support • Soporte de instalación • Support d'installation

Personal Assistance, Product Specs, & "How-to" Questions:

Asistencia personal, especificaciones del producto y preguntas sobre "cómo hacerlo":

Aide personnelle, spécifications du produit et questions « pratique-pratiques » :

1-800-PFAUCET (732-8238)

pfisterfaucets.com/support

Installation Videos Available
Vídeos de instalación a disposición
Vidéos d'installation disponibles



pfisterfaucets.com/videos

▲ WARNING / ADVERTENCIA / AVERTISSEMENT

To reduce the risk of injury or property damage, read all instructions before installing product. Wear safety goggles. Product must be installed in accordance with all state & local plumbing & building codes. Call a professional if you are uncertain about installing this product.

This product has been designed for use with the Pfister™ OX8 Series Pressure Balancing Valve. It will not work with any other product valve. Please review the OX8 valve installation instructions before installing this product.

Para disminuir el riesgo de lesiones o daños a la propiedad, lea todas las instrucciones antes de instalar el producto. Utilice gafas de seguridad. El producto deberá instalarse de acuerdo con la normativa de plomería y construcción estatal y local. Llame a un profesional si no está seguro sobre cómo instalar este producto. Este producto ha sido diseñado para usar con la válvula de equilibrio de presión de la Serie OX8 de Pfister™. No funcionará con cualquier otra válvula. Revise las instrucciones de instalación de la válvula OX8 antes de instalar este producto.

Pour réduire le risque de blessures ou de dommages, lire toutes les instructions avant d'installer l'appareil. Porter des lunettes de sécurité. Il faut installer l'appareil en respectant tous les codes de construction et de plomberie locaux et d'État. Appelez un professionnel si vous n'êtes pas certain de la façon d'installer cet appareil. Cet appareil a été conçu pour être utilisé avec la valve d'équilibrage de pression Pfister™ OX8. Il ne fonctionnera pas avec la valve d'un autre appareil. Veuillez lire les instructions d'installation de la valve OX8 avant d'installer ce produit.

**Required Tools
Herramientas necesarias
Outils nécessaires**



Teflon Tape
Cinta de teflón
Ruban en téflon



Adjustable Wrench
Llave ajustable
Clé réglable



Phillips Screwdriver
Destornillador de estrella
Tournevis Phillips



Safety Goggles
Anteojos de seguridad
Lunettes de sûreté

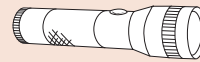

Flashlight
Linterna
Lampe-torche



Cloth
Paño de limpieza
Chiffon

Parts in the Box • Piezas en la caja • Pièces dans la boîte



A

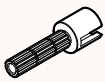

B



C



D



E

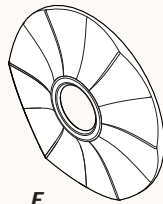

F

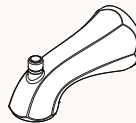

G



H

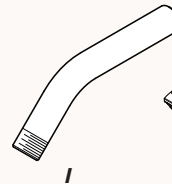

I



J



Supplied Hex Wrench
Proveído Llave hexagonal
Fourni Clé hexagonale

1 Turn Off Water Supply • Cierre el suministro de agua • Couper l'alimentation en eau

Locate water supply inlets and shut off the water supply valves. These are usually found under the sink or near the water meter. If you are replacing an existing faucet, remove the old faucet from the sink and clean the sink surface thoroughly.

Ubique las entradas del suministro de agua y cierre las válvulas de suministro de agua. Generalmente se encuentran debajo del fregadero o cerca del medidor de agua. Si se trata de un reemplazo de grifo, quite el grifo viejo y limpie completamente la superficie del fregadero.

Repérer les arrivées d'eau et fermer leurs robinets. Ces robinets se trouvent généralement sous le lavabo ou à côté du compteur d'eau. En cas de remplacement d'un robinet existant, le déposer du lavabo et nettoyer soigneusement la surface de ce dernier.

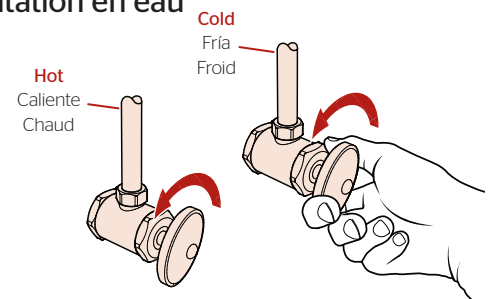

2 Prepare for Installation

Preparación para la instalación

Préparez pour installer

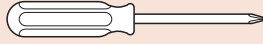

Phillips Screwdriver
Destornillador de estrella
Tournevis Phillips

No Parts Required for This Step
No se necesitan piezas para este paso
Aucune pièce nécessaire pour cette étape

2A

Work Area Inspection Inspección del área de trabajo Contrôle de la zone de travail

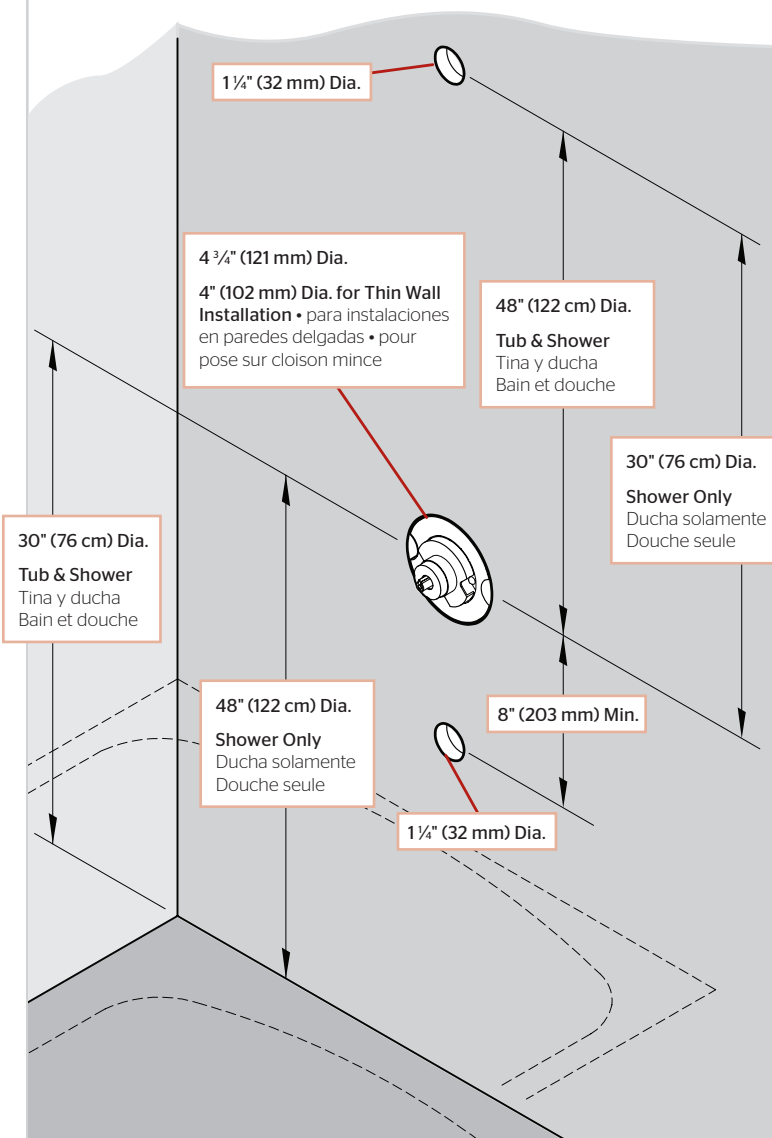

2B

Plasterguard Options Opciones para cubierta protectora para yeso Options de para-plâtre

Thin Wall Installation (1 3/8" Max)

Instalación en pared delgada (35 mm)

Installation avec mur mince (35 mm)

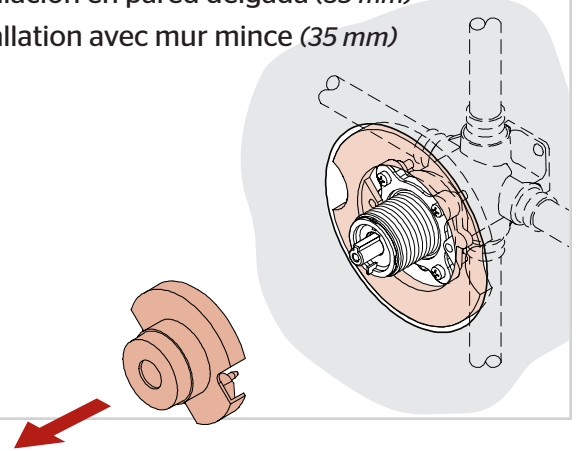

Thick Wall Installation (2 3/4" Max)

Instalación en pared gruesa (41 mm - 70 mm)

Installation avec mur épais (41 mm - 70 mm)

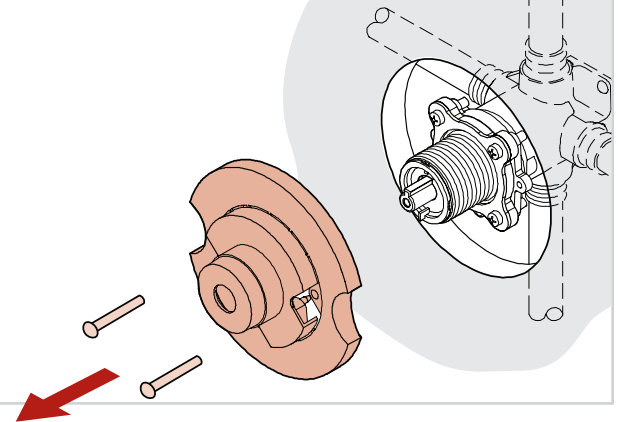

3 Install Retainer and Stem - Instale el anillo de retención y el tallo - Installez retenue et la tige

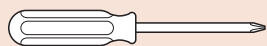

Phillips Screwdriver
Destornillador de estrella
Tournevis Phillips

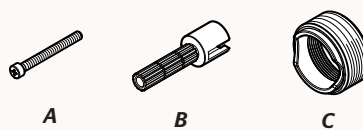

3A

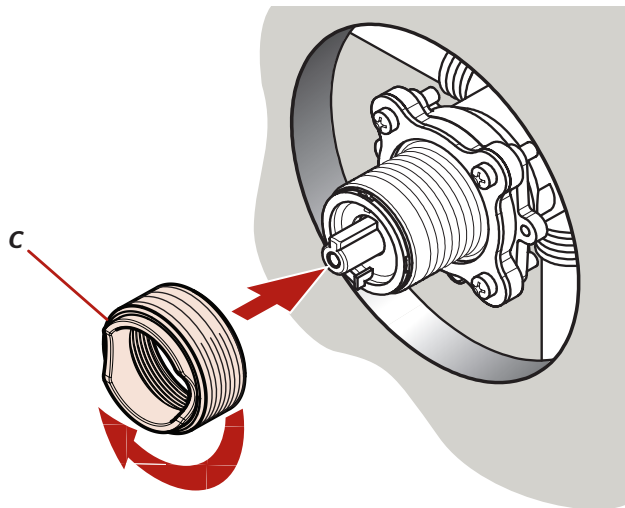

3B

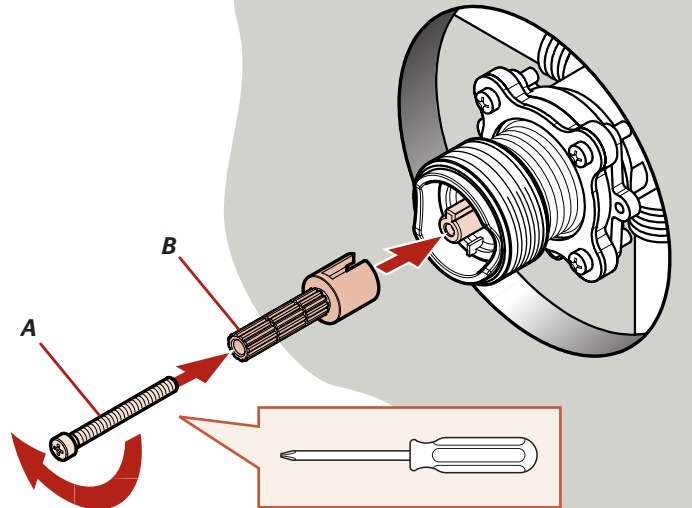

4 Install Flange and Handle - Instale la brida y el mango - Installez la bride et gérer

No Tools Required for This Step
No se necesitan herramientas para este paso
Aucun outil n'est nécessaire pour cette étape

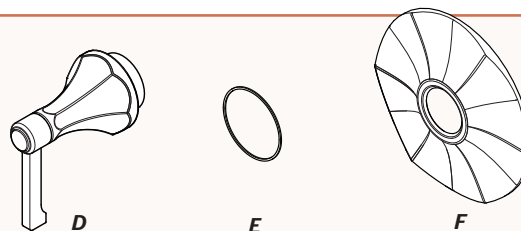

4A

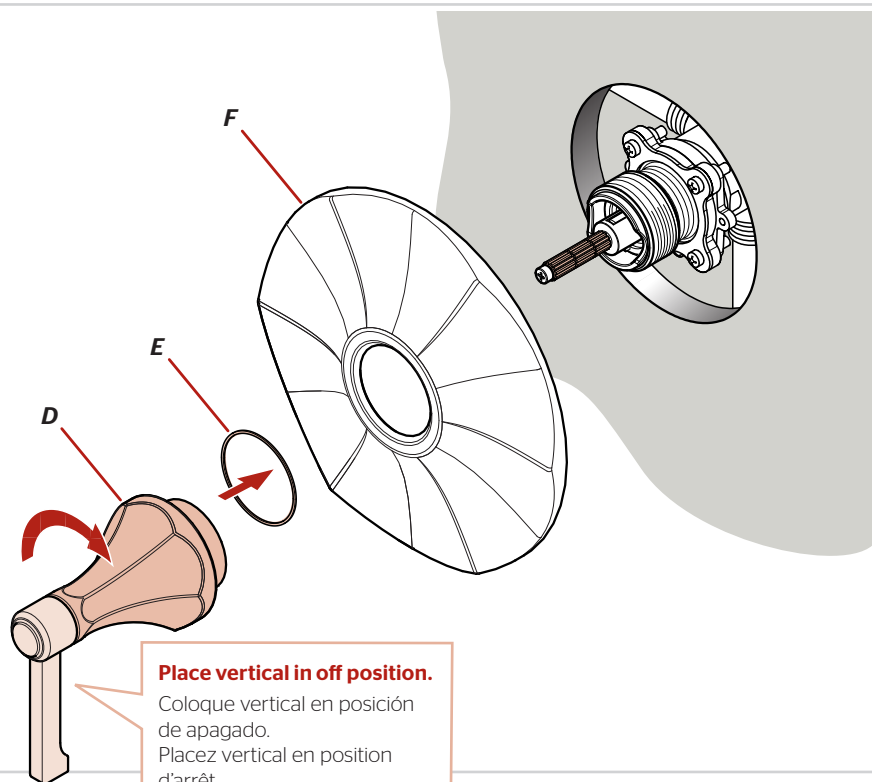

Place vertical in off position.

Coloque vertical en posición de apagado.
Placez vertical en position d'arrêt.

5 Connect Shower Arm & Spout

Conecte el brazo de la ducha y el surtidor
Branchez le bras de douche & le bec

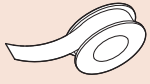

Teflon Tape
Cinta de teflón
Ruban en téflon



Supplied Hex Wrench
Proveído Llave hexagonal
Fourni Clé hexagonale

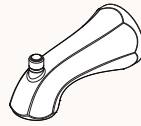

G



H

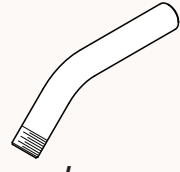

I

5A

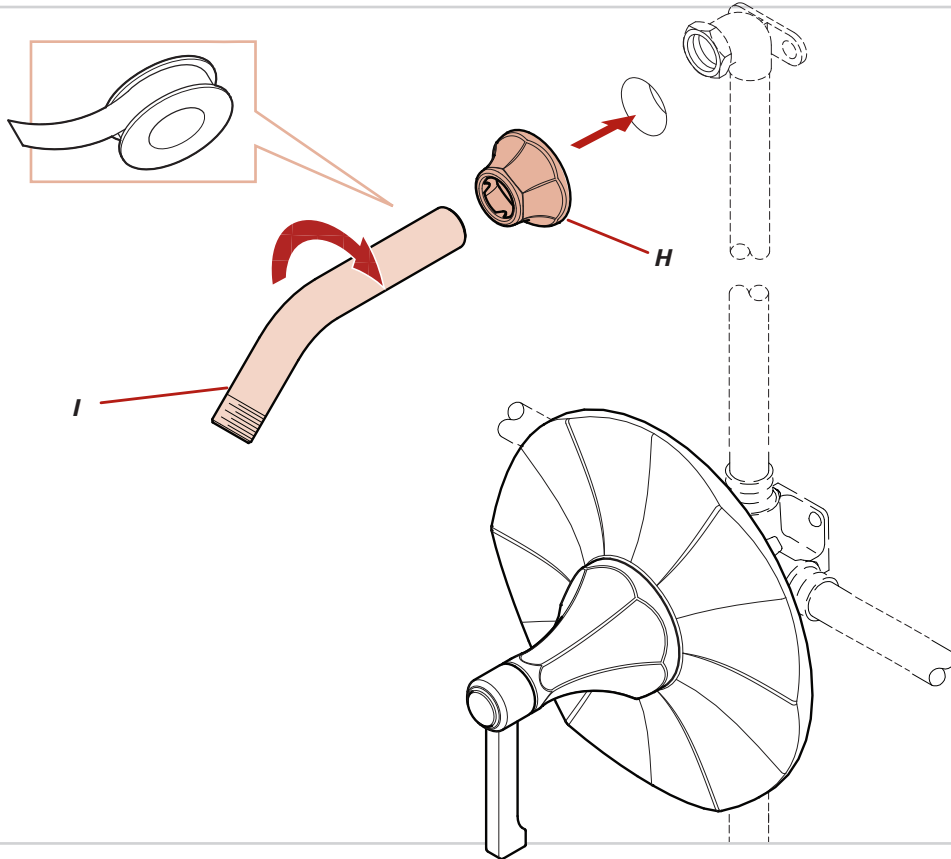

5B

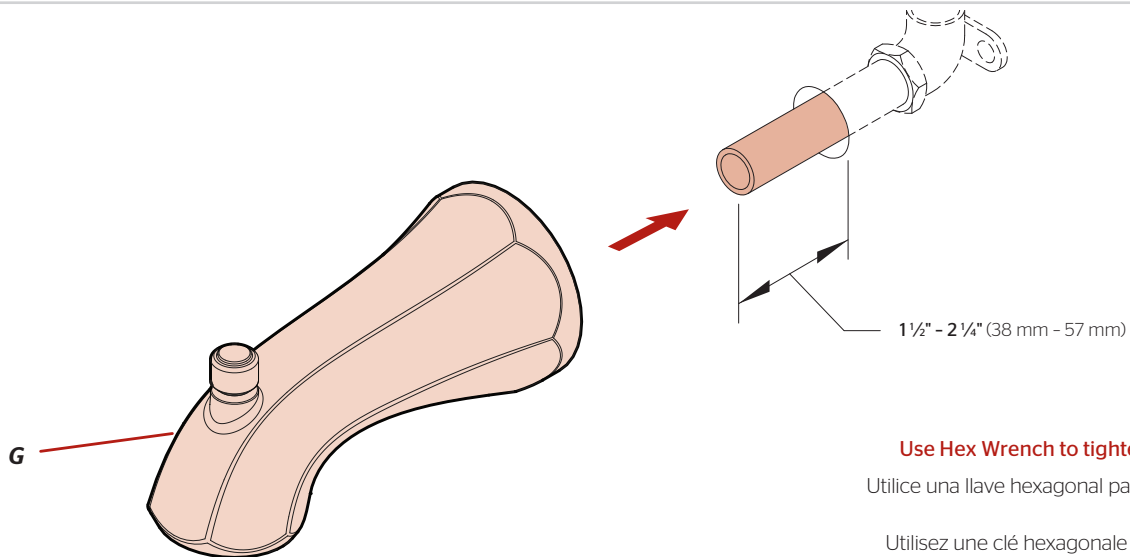

6 Turn On Water & Flush

Active el suministro de agua y enjuague

Ouvrez l'eau et vidangez

No Tools Required for This Step
No se necesitan herramientas para este paso
Aucun outil n'est nécessaire pour cette étape



J

Shower Functions • Funciones de la ducha • Fonctions de la douche

Pull up to turn on shower.

Hale hacia arriba para activar la ducha.

Tirez vers le haut pour mettre la douche en marche.

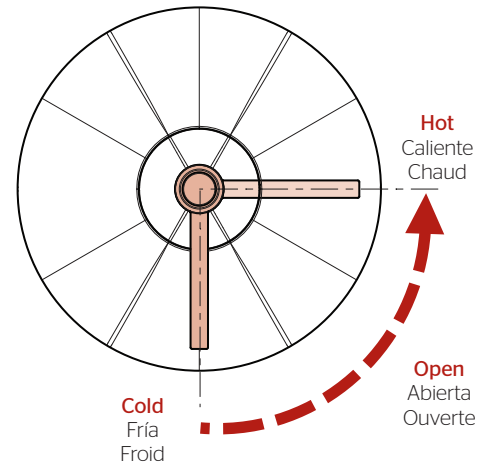
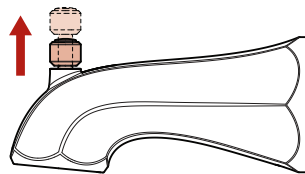

6A

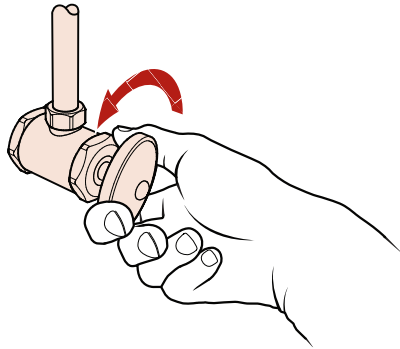

Turn on your water supply & check for any leaks.

Active el suministro de agua y revise si hay fugas.

Rétablissez l'alimentation en eau et vérifiez s'il y a des fuites.

6B

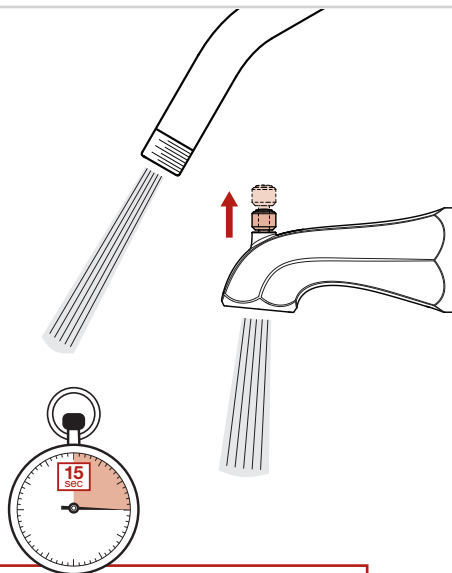

Allow full hot & full cold water to run for at least 15 seconds each.

Deje correr el agua caliente y fría durante al menos 15 segundos cada una.

Permettez à l'eau chaude et l'eau froide de couler au moins 15 secondes chacun.

6C

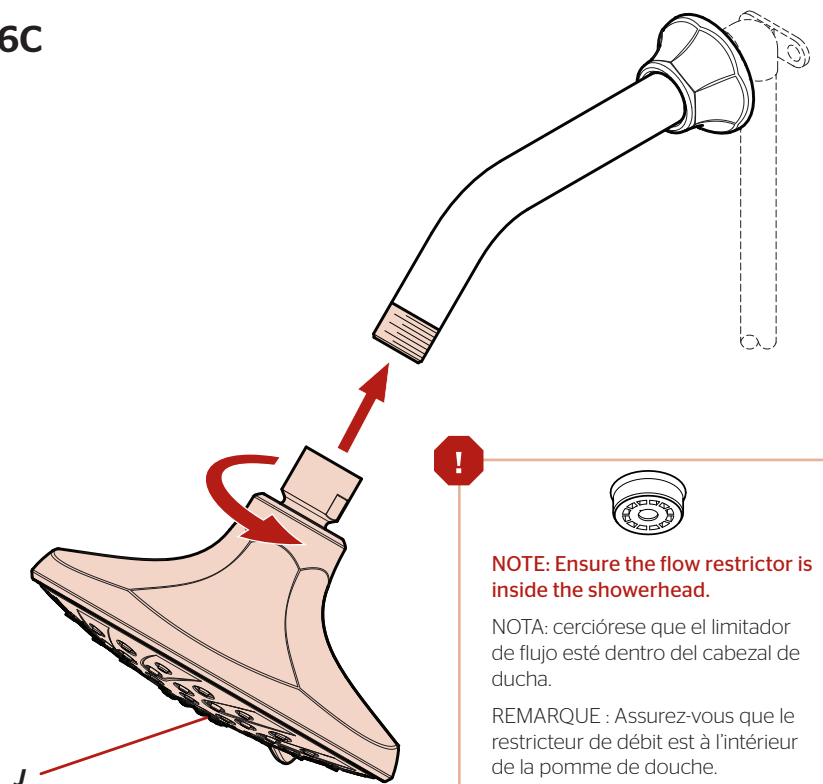

NOTE: Ensure the flow restrictor is inside the showerhead.

NOTA: cerciórese que el limitador de flujo esté dentro del cabezal de ducha.

REMARQUE : Assurez-vous que le restricteur de débit est à l'intérieur de la pomme de douche.

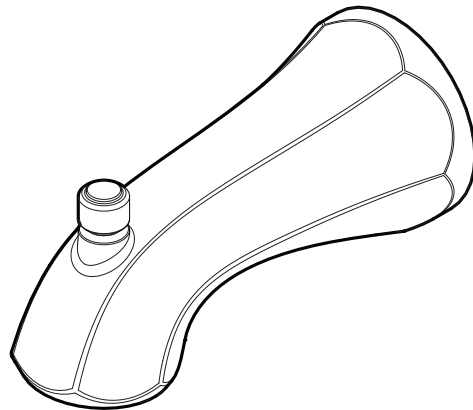
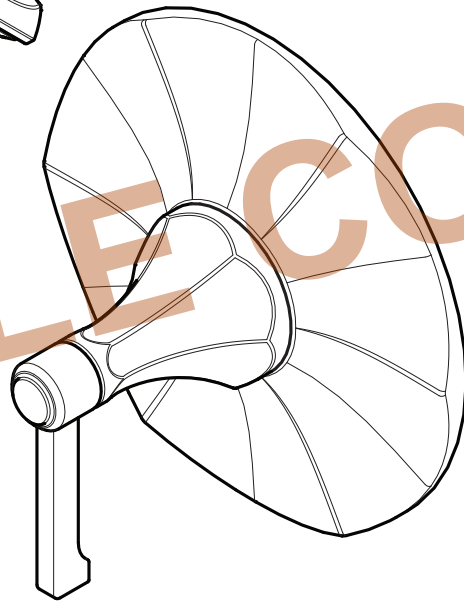
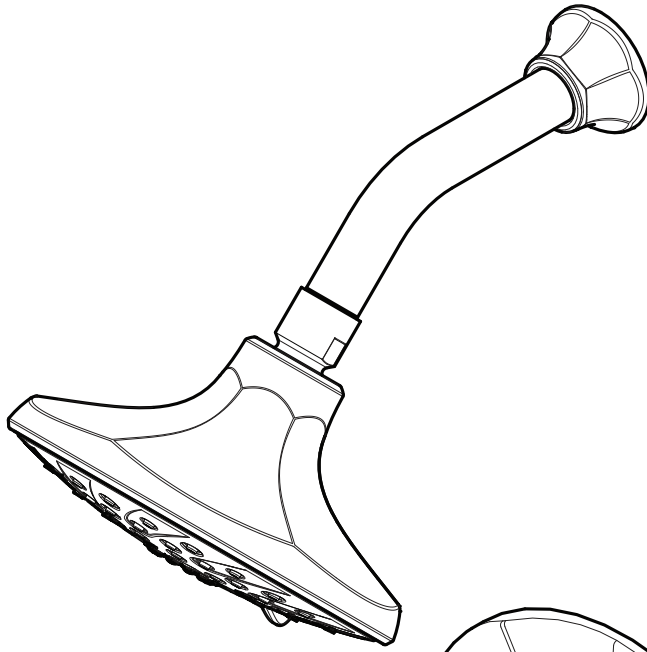

SAMPLE COPY

For Additional Installation Help:

Para la instalación adicionales de ayuda:

Pour aider à l'installation supplémentaires:

PfISTER

1-800-PFAUCET (732-8238)
pfisterfaucets.com