



ENGINEERING EXCELLENCE

Installation Guide

Single Handle Tub & Shower Trim Set:





- | | | |
|------------|------------|------------|
| • 4LG100T* | • 4AM100T* | • 4BR310T* |
| • 4LG300T* | • 4AM200T* | • 4BR410T* |
| • 4BL100T* | • 4AM300T* | • 4BR120T |
| • 4BL200T* | • 4AM400T* | • 4BR220T |
| • 4BL300T* | • 4BR100T* | • 4BR320T |
| • 4BL400T* | • 4BR200T* | • 4BR420T |
| • 4DM100T* | • 4BR300T* | • 4BR130T* |
| • 4DM200T* | • 4BR400T* | • 4BR230T* |
| • 4DM300T* | • 4BR110T* | • 4BR330T* |
| • 4DM400T* | • 4BR210T* | • 4BR430T* |

This product meets the following standards:

- ASME A112.18.1
- ANSI A117.1
- CUPC / IAPMO LISTED / ADA COMPLIANT

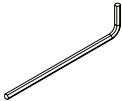
Thank you for purchasing this pioneer quality product.

Tools Required

				
Teflon Tape	3/32" Allen Wrench	Strap Wrench	Thermometer	Plumbers Putty

Prior to Installation

- Observe all local plumbing and building codes before you begin installation.
- The finished wall and tub/shower valve(4020B) must be installed prior to installing this trim.
- Pioneer reserves the right to make changes in the design of faucets without notice as specified in the pricebook.

Caution: (1). These products may cause personal injury due to scalding if the temperature is set too high. We recommend that temperature is set below 120 ° F (49 ° C).

Trim Installation

- Remove the temporary nipple.
- **For Slip-Fit Installation (For 4LG100T,4BR1X0T, 4BR2X0T Only):-**
- The 1/2" nominal copper tube must be cut with a minimum length of A to maximum length of B from finished wall.
- The end of copper tube should be chamfered free of burrs to prevent cutting or nicking o-ring inside the tub spout. The outside surface may be sanded free from nicks and scratches.
- For tub spout with the tub spout escutcheon slide the spout escutcheon along the copper pipe. Press and twist the spout over copper tube flush with the spout escutcheon on the finished wall.
- Tighten the set screw, do not over-tighten.
- **For IPS Installation (For All Installation):-**
- The 1/2" threaded pipe nipple must be kept with the minimum length of C to maximum length of D from finished wall.
- Remove the octagonal nut (For 4LG100T, 4BR1X0T, 4BR2X0T) inside the spout by using nose plier.
- For tub spout with tub spout escutcheon slide the spout escutcheon along threaded pipe nipple. Apply teflon tape at the threaded connection. Screw tub spout onto the threaded pipe nipple flush with the spout escutcheon on the finished wall and tighten by strap wrench.

Trim Installation

For 4LG100T, 4BR1X0T And 4BR2X0T
Slip Fit Installation

Item#	A	B
4LG100T	1-7/8"	2-3/4"
4BR1X0T	2-1/8"	2-7/8"
4BR2X0T		

A Minimum to
B Maximum

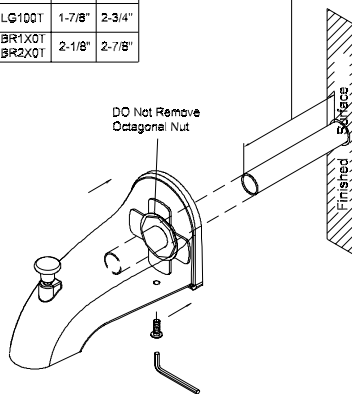

For All Installation

1/2" IPS Installation

Item#	C	D
4LG100T	3/4"	1-3/16"
4BR1X0T	1-1/4"	1-5/8"
4BR2X0T		
4BW100T/4BW200T 4BK100T/4BK200T 4AN100T/4AN200T	1-3/8"	1-5/8"

C Minimum to
D Maximum

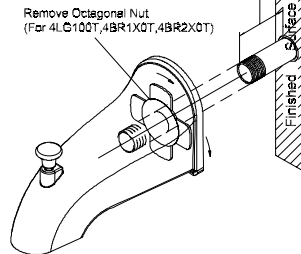

Trim Installation

- Caution:- To avoid plugging the shower head spray outlet it is recommended to use teflon tape on the shower arm threads.
- Remove temporary nipple from the shower elbow.
- Use silicon to caulk the back of the shower arm flange(C).
- Slide the shower arm flange(C) over the shower arm(D).
- Apply the teflon tape on both threaded ends of shower arm(D) and install the shower arm(D) to the shower elbow.
- Carefully tighten with a clean strap wrench.
- press the shower arm flange(C) against the finished wall.
- Flush out the system.
- Thread the shower head(E) to the shower arm(D).

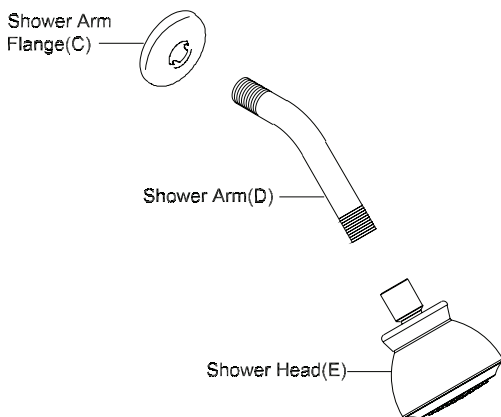

Trim Installation

1. Turn off the main water supply
2. Remove test cap (F) with the help of 1-11/32" socket, ensure all the debris are flushed out of the system. relieve the water pressure.
3. Thread sleeve (G) to the valve body. Insert the cartridge (H) to the valve body. Ensure the 'UP' symbol on the cartridge is on the top. Ensure the two notches underneath of the cartridge seats properly in the valve body. Hold the cartridge (H) and thread the locknut(I) to sleeve(G). Thread retainer cap (J) to locknut (I).
4. For back to back installation:- Rotate the cartridge 180 degree. Ensure 'B-B UP' symbol on the cartridge is on the top. Follow the instruction on 3 to install sleeve (G), locknut (I) and retainer cap (J).
5. Turn on the water supply. Check for any leak. Turn the cartridge (H) counterclockwise to the full open position. Allow water to run for some time until the hot water comes out. Check the temperature with thermometer for the hot water.
6. If necessary to reduce the hot water temperature then, turn off water supply. Remove the cartridge by removing retainer cap(J) and locknut (I). Turn red temperature adjusting ring (K) clockwise to decrease the temperature. Follow instruction 3 or 4 to reassemble the cartridge(H). Ensure the hot water temperature is set below 120 ° F.

Trim Installation

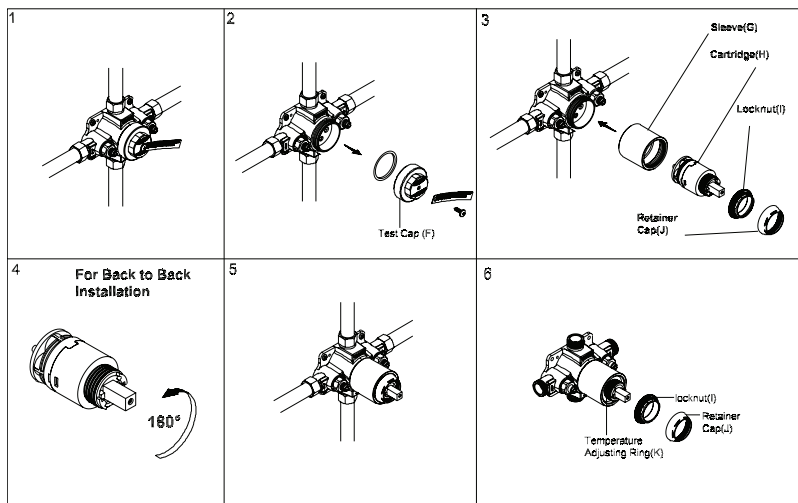

Trim Installation

- Slide the face plate(L) on the valve. Ensure the rubber gasket is placed behind the face plate (L) to form water tight seal.
- Secure the face plate(L) on the valve with the help of face plate screws (M). Use silicon to caulk around the face plate (L).
- Place the handle (N) on the stem. Secure the handle by tightening the allen screw (O). For 4DM100T,4DM200T & 4DM300T use 3/32" allen wrench and for 4LG100T & 4LG300T use 1/8" allen wrench.

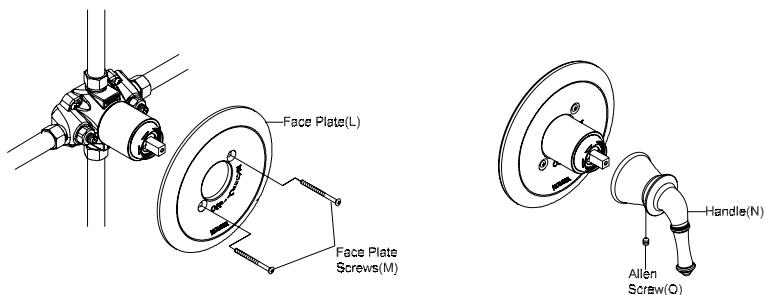

For more care information or trouble shooting inquiries about your Pioneer Product, please see the contact information on the back page.



ENGINEERING EXCELLENCE

3325 S. Garfield Ave. | Commerce, CA 90040
Telephone: (800) 338-9468 | (323) 888-8873 | Fax: (323) 888-9515
Hours: M - F, 7:30am to 5:00pm PST
www.pioneerind.com