



ENGINEERING EXCELLENCE

Installation Guide

Single Handle Kitchen Faucet:





- 2VL160
- 2VL161
- 2VL260
- 2VL261

This product meets the following standards:

- ASME A112.18.1
- ANSI A117.1
- ANSI / NSF 61, SECTION 9
- CUPC / IAPMO LISTED / ADA COMPLIANT
- CONTAINS NO MORE THAN 0.25% WEIGHTED AVERAGE LEAD CONTENT

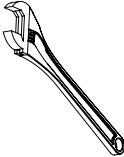
Thank you for purchasing this Pioneer quality product.

Tools Required

				
Adjustable Wrench	Teflon Tape	Rags	3/32" Allen Wrench	

Prior to Installation

- Observe all local plumbing and building codes before you begin installation.
- Carefully shut off both hot and cold water supplies.
- Plug the sink drain with a soft cloth to prevent intrusion of debris or the loss of any parts.
- Pioneer reserves the right to make changes in the design of faucets without notice.

Faucet Installation

- Note:- For 2VL160, 2VL161 the faucet escutcheon is supplied with rubber washer (B) to form watertight seal. Do not use plumbers putty on marble countertop As it may leave stain on the surface.
- For three hole - place deck cover plate (A) underneath of the faucet.
- For Single hole -place rubber washer (B) underneath of the escutcheon.
- Slide Inlet flex hoses (C) through Faucet Hole
- Slide mounting bracket (D) to the mounting bolt from underneath of the sink.
- Thread mounting nut (E) to the mounting bolt.
- Clean the surface if necessary.

Faucet Installation Drawing

For 3-Hole Installation

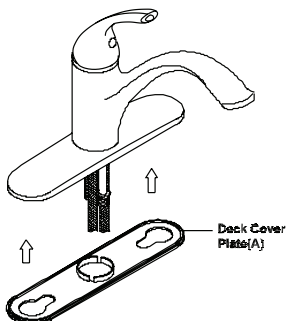

For 1-Hole Installation

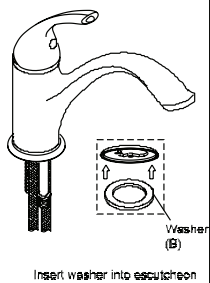

For 1 or 3-Hole Installation

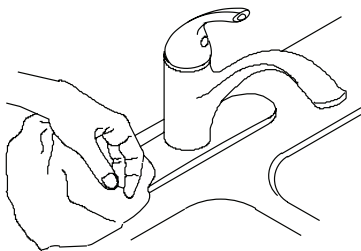
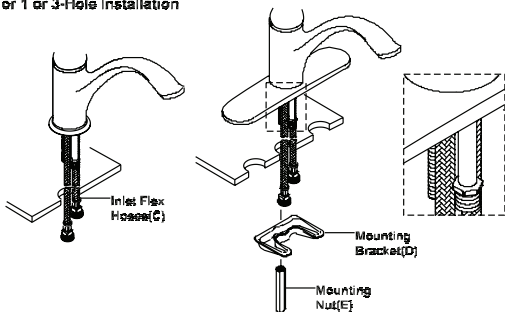

Faucet Installation

- **For faucet with side spray (2VL161 and 2VL261):-** Apply plumbers putty at the edge of the hose guide (F). Place the hose guide through mounting hole.
- Thread the mounting nut (G) to the hose guide (F) from underneath of the sink. Do not overtighten.
- Lead the side spray hose (I) through hose guide (F). Connect side spray hose (I) to the side spray port (H).

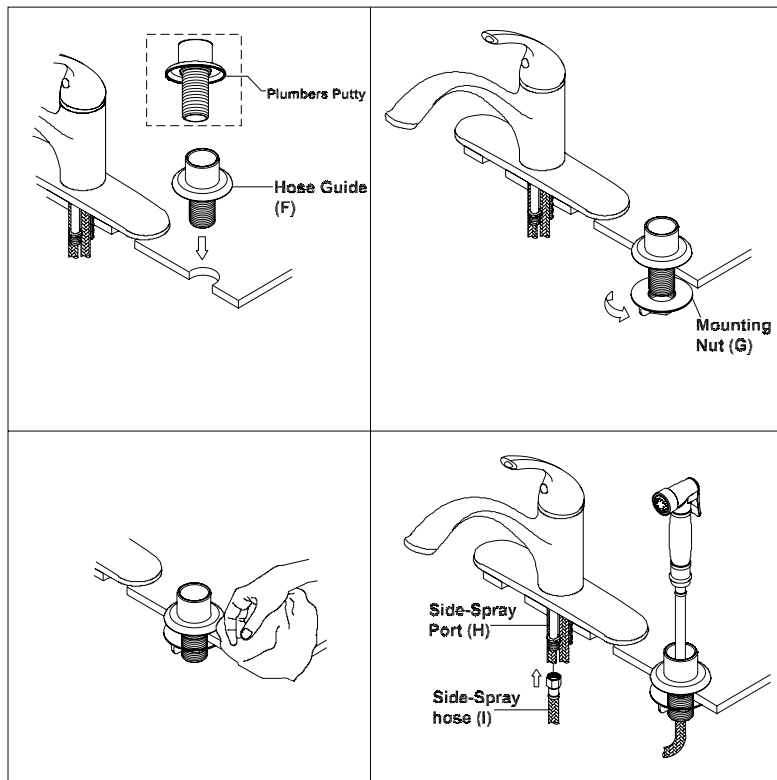

Faucet Installation

- Use main supply hoses (J) to connect inlet flex hoses (C) to the main supply stops (K). Tighten with adjustable wrench. Do not overtighten. Conventionally left is hot and right is cold.
- Turn on water. Check of any leaks. Make sure all the connection are secure.
- Remove the aerator (L) from the spout by turning counterclockwise. as shown.
- Turn on the handle.
- Flush and allow water to run at full flow for at least one minute.
- Turn off water. Replace aerator (L) by turning clockwise.

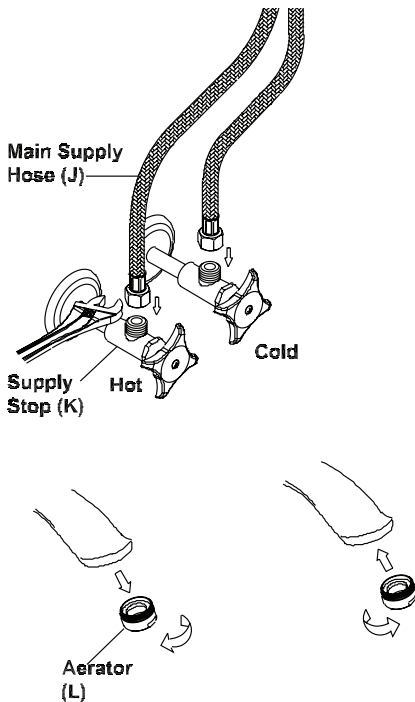

To Set or Adjust Temperature Limit Stop

Caution: Valve is preset at the factory test at maximum. Adjust as necessary. Please see the instructions below:

- Turn off main supply stops and relieve the pressure.
- Remove handle (M) by removing hole cover (N) and loosening set screw (P) lift off.
- Unscrew retainer sleeve (Q) and retaining nut (R) counterclockwise.
- Use two fingers raise the red adjustment ring (S).
- Turn adjustment ring counterclockwise to decrease the temperature setting and clockwise to increase the temperature. Replace the adjustment ring (S).
- Reassemble and test until desired safe temperature is reached. (Note: Ensure proper alignment of cartridge with notch in valve body.)

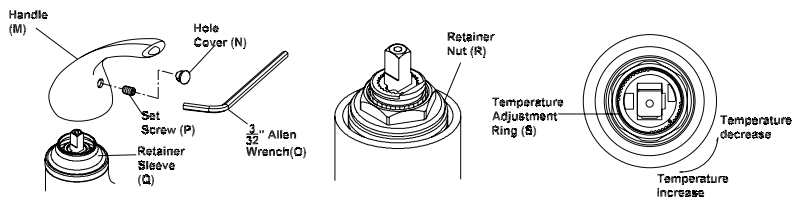

For more care information or trouble shooting inquiries about your Pioneer Product, please see the contact information on the back page.



ENGINEERING EXCELLENCE

3325 S. Garfield Ave. | Commerce, CA 90040
Telephone: (800) 338-9468 | (323) 888-8873 | Fax: (323) 888-9515
Hours: M - F, 7:30am to 5:00pm PST
www.pioneerind.com