

MS854114SL

MS854114SL
CST854SL

Ultramax®
1.6 Gpf Toilet, Elongated,
G-Max®, ADA, 12" Rough-In

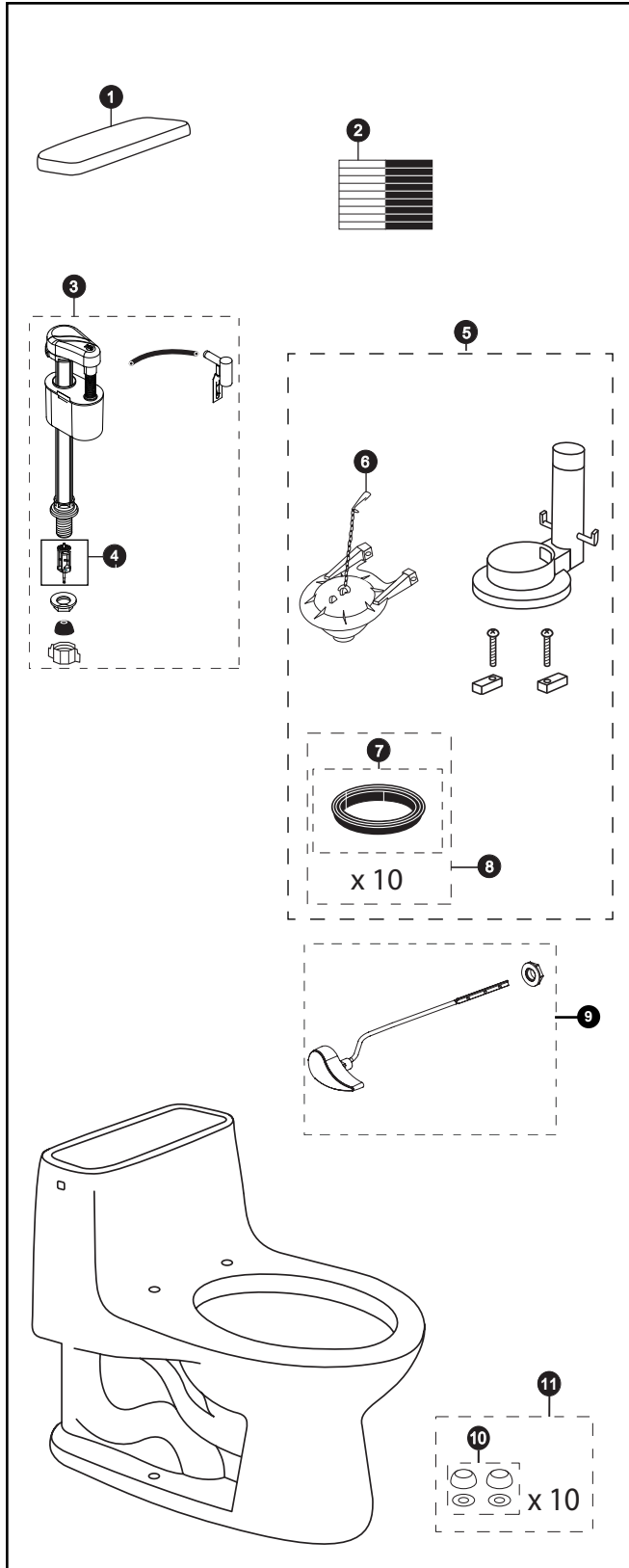

Item	Part	Description
1	TCU854CRS#01	Tank Lid w/ Velcro Tape
	TCU854CRS#03	Tank Lid w/ Velcro Tape
	TCU854CRS#04	Tank Lid w/ Velcro Tape
	TCU854CRS#11	Tank Lid w/ Velcro Tape
	TCU854CRS#12	Tank Lid w/ Velcro Tape
	TCU854CRS#51	Tank Lid w/ Velcro Tape
2	THU107	Velcro Tape
3	TSU18A	Fill Valve
4	THU229	Fill Valve Filter
5	THU013W	Flush Valve Assembly w/ Flapper
6	THU175S	Flapper w/ Chain
7	9BU002E	Flush Valve Gasket (1 Piece)
8	THU097	Flush Valve Gasket (10 Pieces)
9	THU004#01	Trip Lever
	THU004#03	Trip Lever
	THU004#04	Trip Lever
	THU004#11	Trip Lever
	THU004#12	Trip Lever
	THU004#51	Trip Lever
	THU004#CP	Trip Lever
	THU004#BN	Trip Lever
THU004#PN	Trip Lever	
10	THU098#01	Bolt Cap & Base - Cotton
	THU098#03	Bolt Cap & Base - Bone
	THU098#04	Bolt Cap & Base - Gray
	THU098#11	Bolt Cap & Base - Colonial White
	THU098#12	Bolt Cap & Base - Sedona Beige
	THU098#51	Bolt Cap & Base - Ebony
11	THU044S#01	Bolt Cap Set - Cotton
	THU044S#03	Bolt Cap Set - Bone
	THU044S#04	Bolt Cap Set - Gray
	THU044S#11	Bolt Cap Set - Colonial White
	THU044S#12	Bolt Cap Set - Sedona Beige
	THU044S#51	Bolt Cap Set - Ebony

Product Number Explanations

One-Piece Toilet

(MS) Toilet & Seat Combination
(854) Toilet Model
(114) Seat Model
(S) G-Max®
(L) ADA Compliant

One-Piece Toilet

(CST) Gravity Type Toilet
(854) Model
(S) G-Max®
(L) ADA Compliant

Colors

(#01) Cotton
(#03) Bone
(#04) Gray
(#11) Colonial White
(#12) Sedona Beige
(#51) Ebony

Finishes

#CP - Chrome Plated
#BN - Brushed Nickel
#PN - Polished Nickel

Actual product may differ slightly from illustration