



LAVATORY FAUCET

- **Z Collection**
- **Two-Handle Widespread Deck Mount**
- **3-Hole Installation**
- **6" to 10" Centers**

STANDARD SPECIFICATIONS

- Ceramic disc cartridge
- Metal pop-up assembly
- Copper tube inlet with 1/2" male NPSM connection
- NEOPERL® aerator 1.5gpm max @ 60psi

FINISHES INCLUDE

- Chrome (UF55710)
- Brushed nickel (UF55713)

WARRANTY

- Limited lifetime warranty on workmanship and materials to the original purchaser

COMPLIES WITH

- NSF 61-9
- ASME A112.18.1
- CSA B125.1
- cUPC
- AB1953
- WaterSense
- CALGreen

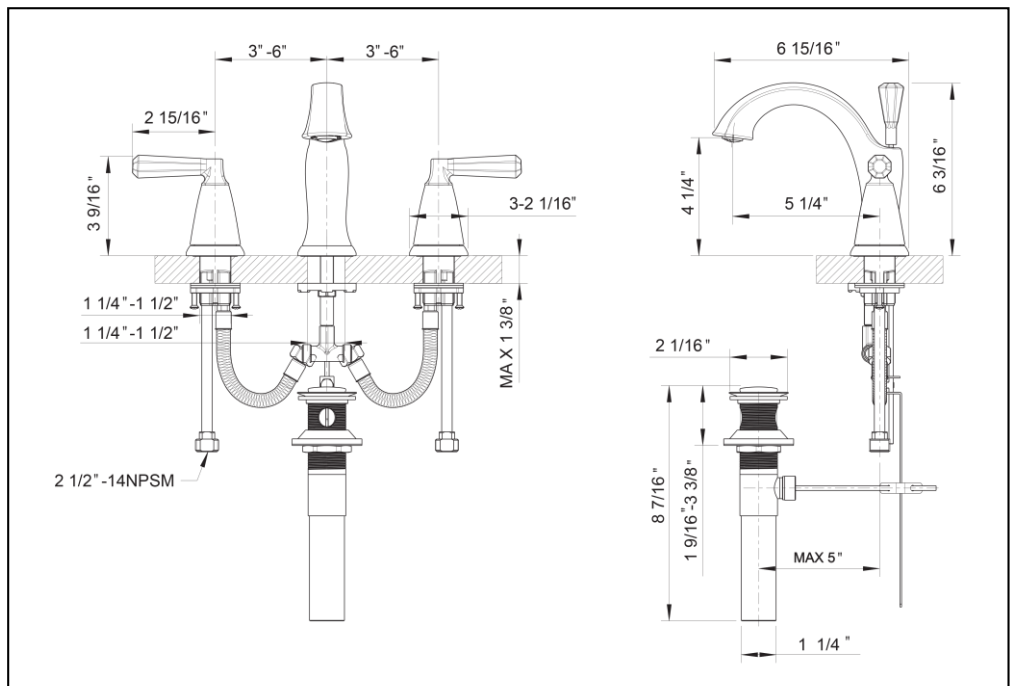

tel. 888-OK-ULTRA (658-5872) • fax. 949-225-6099 • <http://www.ultrafaucets.com>

This specification is provided for reference only. Ultra Faucets reserves the right to modify specifications and materials without notice or obligation.