



## Precision™ Soil Sensor System User's Guide

### Introduction

Leveraging the same Toro soil-sensing technology used on high-end commercial sites and world-class golf courses, the Toro Precision™ Soil Sensor continuously monitors the soil moisture and determines when watering is actually needed – greatly increasing the efficiency of your sprinkler , reducing wasteful over-watering, while promoting the overall health and beauty of your landscape.

The Precision Soil Sensor system consists of a wireless soil moisture sensor and digital receiver, making installation quick and simple. The compact receiver installs alongside the timer, either indoors or out, and connects directly to the timer's power and sensor terminals, or simply taps into the valve common wire circuit. The sensor is placed in a suitable lawn area where it sends soil moisture and air temperature readings to the receiver every 10 minutes. When automatic watering is scheduled to start, the Precision Soil Sensor allows the sprinklers to run only if the soil moisture has dropped below the minimum moisture setting, and the air temperature is favorable for watering.

The sensor simply plugs into the soil – so there's no holes to dig or wires to bury. All you'll need to complete the installation is a small Phillips screwdriver, three AA alkaline batteries and a bit of do-it-yourself enthusiasm.

*💧 The Precision Soil Sensor system is designed to help grow and maintain healthy landscape vegetation while reducing water use by improving the operation of your sprinkler control timer. It cannot improve or remedy a sprinkler system that's improperly designed, installed or maintained. So, to gain the maximum benefit afforded by the addition of the Precision Soil Sensor, it is vitally important to make certain your automatic sprinkler system is in good working order; capable of providing proper sprinkler coverage—where and when it's needed.*

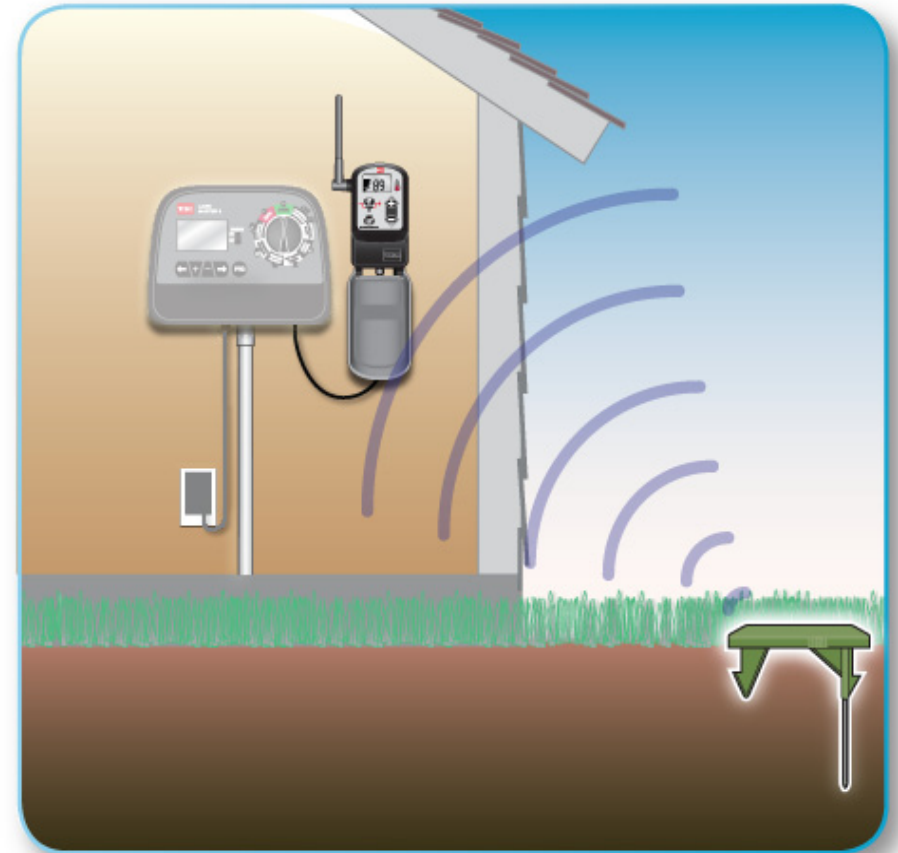

# Table of Contents

<b>Introduction</b> .....	1	<b>System Calibration and Learn Modes</b> .....	7
<b>System Component Overview</b> .....	3	• System Calibration Mode .....	7
<b>System Operating Modes</b> .....	4	• Sensor Learn Mode .....	7
• Normal Operating Modes .....	4	<b>Installation and Setup Procedures</b> .....	8
• Watering Permitted .....	4	• Install Receiver .....	8
• Watering Restricted .....	4	• Connect Receiver to Timer .....	8
• Smart Bypass Mode .....	4	• Select Sensor Installation Site .....	8
• Freeze Shut-off Mode .....	4	• Install Sensor Batteries .....	8
<b>System Status Indicators</b> .....	5	• Install Sensor .....	8
• Warning Mode Indicator .....	5	• Adjust the Automatic Watering Schedule .....	9
• Restoring Operation .....	5	<b>Troubleshooting</b> .....	10
• Battery and Signal Strength Indicators .....	5	<b>Specifications</b> .....	11
<b>Soil Moisture Adjustment</b> .....	5	<b>Toro Commitment to Quality</b> .....	11
• Fine-tuning the Soil Moisture Level .....	5	<b>Warranty</b> .....	11
<b>Advanced System Operations Menu</b> .....	6	<b>FCC Part 15 Rules</b> .....	12
• Smart Bypass Timer .....	6	<b>System Operations Menu - Quick Reference</b> .....	12
• Freeze Shut-off Temperature .....	6		
• Watering Completion Time .....	6		
• Signal Strength .....	6		
• Battery Voltage .....	6		
• Sensor ID Code .....	6		
• Air Temperature .....	6		
• Temperature Format .....	6		
• Calibration Mode .....	6		

## System Component Overview

### Receiver

- 1 - Antenna
- 2 - Bypass Sensor Button
- 3 - Bypass Sensor LED Indicator
- 4 - Setup Menu Access Button
- 5 - Cover
- 6 - Connection Wire Cable
- 7 - Setup Menu Adjustment Buttons
- 8 - Watering Status LED Indicators
- 9 - LCD Display Symbols
- A - Soil Moisture Control Indicator
- B - Watering Suspended
- C - Watering Completion Time
- D - Smart Bypass Mode Active
- E - Warning Mode (*communication error*)
- F - System Setup Mode
- G - Freeze Setting Indicator
- H - Temperature Display Format Indicators
- I - Alpha-numeric Display Characters
- J - Battery Status Indicator
- K - Signal Status Indicator
- L - Bar Graph Status Indicator

### Sensor

- 10 - Sensor Signal LED Indicator
- 11 - Soil Moisture Probes
- 12 - Size AA Alkaline Batteries - (*not provided*)
- 13 - Battery Compartment Cover w/Screws

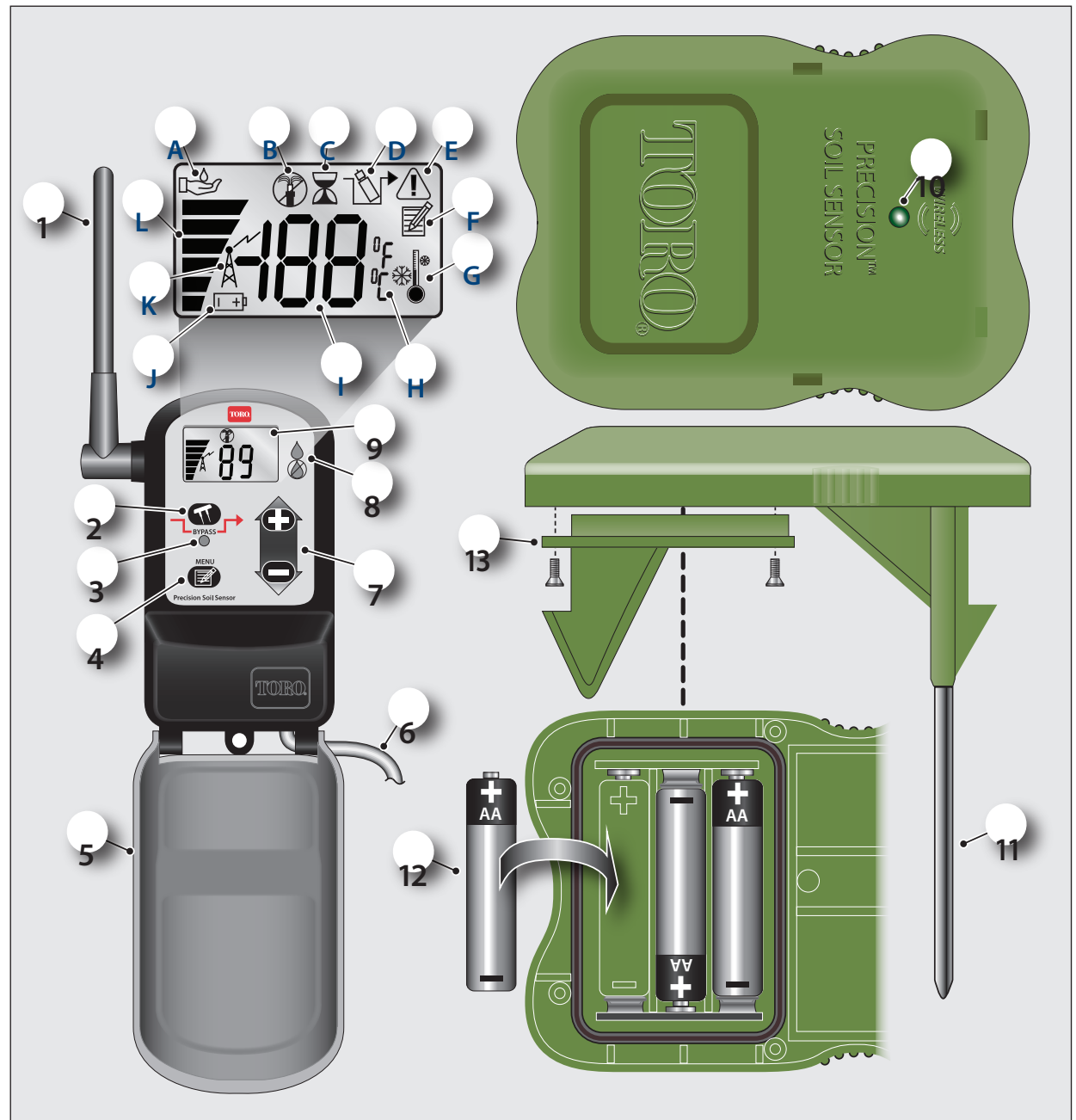

Receiver

Sensor

## System Operating Modes

**Note:** If installation of the Precision Soil Sensor system has not been completed or the system is not yet operational, refer to System Installation and Setup procedures beginning on page 8.

### Normal Operating Modes

#### Watering Permitted

When the Precision Soil Sensor is in the Watering Permitted mode, the current soil moisture % value is displayed, and the Green LED is on. In this example, the current soil moisture level is 42%, which is below the \*50% soil moisture maintenance level, and watering is allowed.

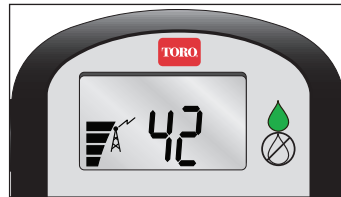

#### Watering Restricted

When the soil moisture is above the \*50% soil moisture maintenance level, the Precision Soil Sensor switches to the Watering Restricted mode. A delay period of \*4 hours begins counting down before watering is actually shut off. The delay period allows any remaining sprinkler zones in the watering cycle to operate. The display will toggle between displaying the current soil moisture % value and the amount of time remaining in the current watering cycle completion period.

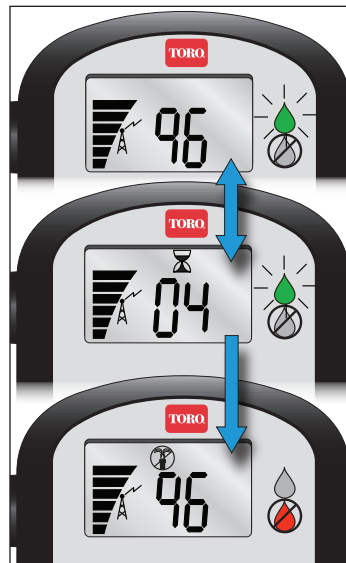

In this example, the moisture level is 96%, and the Green LED is on since watering will be allowed to continue for 4 hours. The Watering Restricted mode will begin immediately following the watering cycle completion period. While in the Watering Restricted mode, the current soil moisture % value with the No Watering  symbol will be displayed, and the Red LED will remain on.

**Note:** Ideally, one watering cycle should replenish the moisture level to 100%. Watering program changes may be required to achieve this condition. Refer to your control timer user's guide for information regarding programming options.

**\*Note:** A value shown with an asterisk (\*) indicates that it is the factory default setting within an adjustable range. Refer to Advanced System Operations Menu beginning on page 6 for detailed information regarding system settings and adjustment options.

#### Smart Bypass Mode

The Smart Bypass feature enables the sprinkler system to operate while the Precision Soil Sensor is in the Watering Restricted mode.

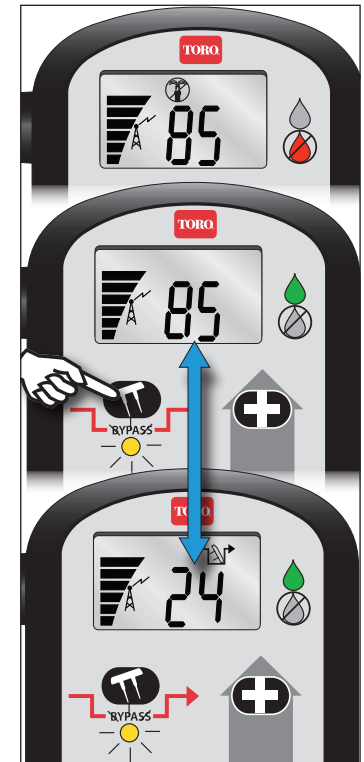

Pressing the Bypass  button toggles the Smart Bypass feature on and off. When switched on, the Bypass mode will be automatically canceled in \*24 hours, or it can be manually canceled at any time.

While the Precision Soil Sensor is in the Smart Bypass mode, the Green LED will be on and the Yellow LED will blink continuously. The display will toggle between the current soil moisture % value and the amount of time remaining until the Watering Restricted mode resumes. In this example the moisture level is 85% and the Green LED is on. There are 24 hours remaining in the Smart Bypass mode.



#### Freeze Shut-off Mode

If the sensor detects that air temperature has dropped to near freezing, the Precision Soil Sensor automatically switches to the Freeze Shut-off mode to restrict watering. When the temperature rises, the Freeze Shut-off mode is canceled. Normal Operation mode will resume after the delay period set by the Smart Bypass Timer.

In this example, air temperature is detected at the minimum setting of \*39°F and watering has been canceled. The Freeze temperature  and No Watering  symbols are displayed, and the Red LED will blink continuously.

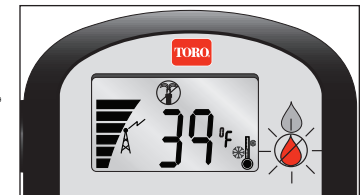

## System Status Indications

### Warning Mode Indication

If the sensor does not communicate with receiver within a 24-hour period, the Precision Soil Sensor switches to the Warning mode, indicated by all three LEDs blinking continuously. Watering will be permitted until the loss of communication has been corrected.

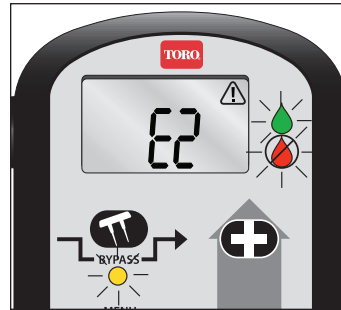

### Restoring Operation









Loss of communication can be caused by a damaged sensor, relocating the sensor to different area of the yard, or a temporary obstruction, such as a car or truck parked in the signal path. However, the most likely cause is the sensor batteries have become too weak to provide adequate signal strength.

If the sensor appearance and location is unchanged, and the signal path is unobstructed, replace the sensor batteries with three new AA alkaline batteries. Press the Bypass  button to cancel the Warning mode. If communication is reestablished, the Precision Soil Sensor will automatically resume normal operating mode within a short time.

**Note:** If the above measures do not restore normal operation, contact Toro Customer Service for assistance at 1-877-345-8676.

### Battery and Signal Strength Indications

The receiver display provides current battery and signal strength status during all normal operating modes. The number of stacked bars that appear with the corresponding antenna and battery display symbols, indicate the current conditions as shown in the chart below.

 Signal	 Battery
 6 Bars = Excellent	 6 Bars = Excellent
 4 Bars = Acceptable	 4 Bars = Acceptable
 2 Bars = Weak - Check Sensor	 2 Bars = Weak - Replace Batteries

## Soil Moisture Adjustment

Landscape plants are the heartiest when their roots become established several inches down where water is stored for the longest period of time. Watering often, for short periods of time, promotes root growth near the top of the soil, where the moisture evaporates quickly.

 *The key to maintaining healthy plants with minimum water waste is to water thoroughly—only when it's needed.*

The Precision Soil Sensor is preset to restrict watering until the soil moisture level drops to 50% of capacity, or 1/2 of the total moisture that can be retained in the soil. If you were



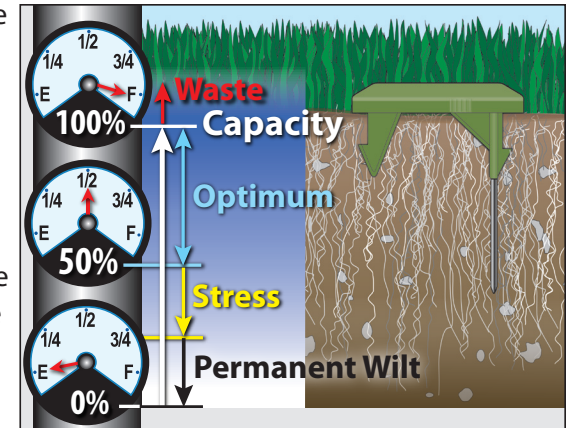

to draw a comparison to a car's fuel tank, 50% of the soil moisture capacity would be similar to using 1/2 of the fuel in the tank before stopping to refill. A 50% setting restricts the sprinklers from refilling the soil to capacity until 1/2 of the moisture has been lost; causing the roots to go deeper for water. With the capability to



adjust the setting incrementally from 0% to 100%, the Precision Soil Sensor can be fine-tuned for virtually any soil condition.

### Fine-tuning the Moisture Level

Changes to the 50% setting should be made initially in 5% increments in order to see results within a few days. The objective is to find the moisture setting that results in a mild stress condition in the lawn, indicated by slight wilting and dryness. At that point, adjust the setting 5% in the opposite direction. This should result in moisture maintenance level that's very close to optimum.

- Press and release the Plus  button to display the current setting (50 % by default).
- Press the Plus  button to increase, or the Minus  button to decrease the setting.
- Press Menu  button to return to the Normal Operating mode.

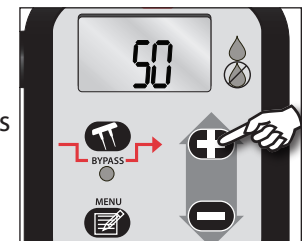













## Advanced System Operations Menu

The Advanced System Operations Menu lists a variety of operational settings and system status indicators. For most residential landscape applications, the default settings will provide good results. Each setting has a range of adjustment enabling its function to be tailored as preferred.

- Press and release the Menu  button to step through the menu sequence shown in the table below.

**Note:** If you step past a specific menu item, continue pressing the Menu button to repeat the menu sequence.

Precision System Menu Item	Default Setting	Range
 System Calibration Mode	Automatic	Manual Reset
 Watering Completion Time	4 Hours	0–24 Hours
 Smart Bypass Timer	24 Hours	1–199 Hours
 Freeze Shut-off Mode Temp	39°F	35–45°F (2–7°C)
 Signal Strength Indicator	Review Only	0.0–10.0+
 Battery Voltage Indicator	Review Only	0.0–4.5+
 Sensor Identification Code	Review Only	00 00 00–99 99 99
 Temperature Format Indicator	°F	°F or °C
 Sensor Temperature	Review Only	14° F –140° F+

- Where applicable, press the Plus  or Minus  buttons to adjust the setting value.
- To exit the Advanced System Operations Menu, either press the Menu  button to display the Operating Mode screen, or allow the receiver to idle for 10 seconds and exit automatically.

### System Calibration Mode

Enables the sensor system to be manually calibrated for current maximum soil moisture content.



### Watering Completion Time (0–24 Hours)

Determines the amount of time allowed for a watering cycle to be completed before the Watering Restricted mode takes effect.



### Smart Bypass Timer (1–199 Hours)

Determines the amount of time the system remains in Smart Bypass mode (and after Freeze Shut-off mode) before returning to the Normal Operating mode.



### Freeze Shut-off Mode Temp (35–45°F or 2–7°C)

Determines the temperature that initiates the Freeze Shut-off mode to suspend watering operation.

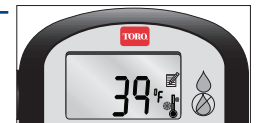

### Signal Strength

Indicates signal strength in a digital format.



### Battery Voltage

Indicates total voltage output of the sensor batteries.



### Sensor ID Code

The Sensor Identification Code is displayed in three number pairs, accessed by repeatedly pressing the Plus or Minus button.



### Temperature Format

Enables temperature format to be displayed in degrees Fahrenheit or Centigrade.



### Sensor Temperature

Indicates the sensor temperature.



## Sensor System Calibration and Learn Modes



### System Calibration Mode

The sensor system will be automatically calibrated within 24–48 hours after the initial installation. Calibration is required to establish the maximum amount of usable moisture in the soil. The sensor system will then recognize this soil moisture level as the maximum capacity. From this fixed reference point, the sensor system can decide when the soil moisture has dropped enough to allow watering.

To manually calibrate the Precision Soil Sensor at any time, for example, if the sensor has been moved to a different location in the landscape, or has been replaced since the initial installation, use the following procedure:

- Approximately 2 to 4 hours prior to performing calibration, run an automatic or manual watering operation to thoroughly irrigate the sensor zone.

**Note:** The objective is to apply as much water as possible to the sensor zone – up to the point of runoff, then allow the soil drain down 2 to 4 hours to establish the maximum moisture-retention capacity.

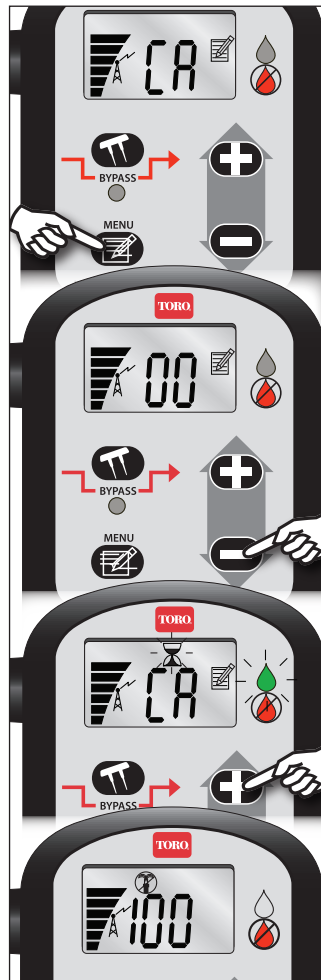

- Press the Menu  button to display CA (system calibration mode).
- Press the Minus  button to display 00.
- Press and hold the Plus  button (several seconds) until the Green LED indicator and hourglass symbol begins flashing. The Red LED will be on.
- The new calibrated moisture % value will be displayed automatically within 10 minutes.



### Sensor Learn Mode

The Precision Soil Sensor receiver has been paired (matched) at the factory to a unique sensor identification code, to prevent communication with other sensors that may be installed within reception range. If either the receiver or sensor is replaced, the frequency pairing procedure is required to enable wireless communication. The receiver Learn mode is provided to accomplish the pairing procedure.

To pair the receiver to the sensor, use the following procedure:

- Press and hold the Bypass  button (without releasing) until the receiver switches to the Learn mode and the display shows LE. The Green LED will turn on, and the Red and Yellow LEDs will begin blinking.
- If the sensor is operational (batteries installed), pairing will occur automatically the next time a signal is sent from the sensor (within 10 minutes). The receiver will automatically return to the Normal Operating mode when communication is established.
- If the sensor batteries have not been installed, automatic pairing will occur upon battery installation. Press the Bypass  button to return to the Normal Operating mode.

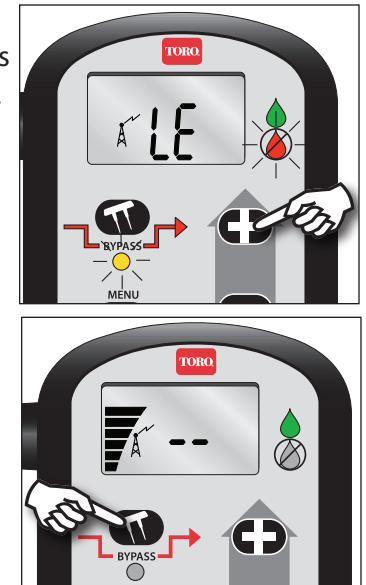

# Installation and Setup Procedures

## Install Receiver

- Position the receiver next to the timer (on the side opposite the timer's hinged cover).
- The receiver can be installed indoors using the mounting tape provided. For outdoor installation, attach the receiver using the two stainless steel screws provided.
- When installed outdoors, the receiver cover should remain closed when access is not required.

1. Drive the top mounting screw into the wall, leaving about 1/8" from flush.
2. Place the receiver on the screw using the key-hole slot.
3. Install and tighten the lower mounting screw.
4. Route the connection cable through the bottom of the timer, into the wire connection area.

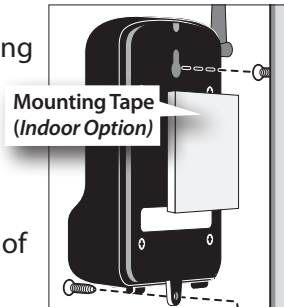

## Connect Receiver to Timer

**Note:** If the timer is equipped with sensor terminals, continue at **Step 1** below. If the timer is **not** equipped with sensor terminals, continue at **Step 1a**. Refer to your timer's user guide for specific information regarding sensor installation and Sensor control switch operation.

**Note:** When the receiver is connected to the timer's sensor terminals, **Rain Hold** will be indicated when the Precision Soil Sensor is actively restricting irrigation. **The Precision Soil Sensor does not replace or function as a Rain Sensor.**

**⚠ Caution:** Ensure the timer's power source is disconnected prior to connecting the receiver wires.

## Setup for Timer With Sensor

1. Locate the Sensor connection terminals. If the timer has (or requires) a jumper wire on the Sensor terminals connect the receiver for **Normally Closed (NC)** operation. If a jumper wire is not required, connect the receiver for **Normally Open (NO)** operation.

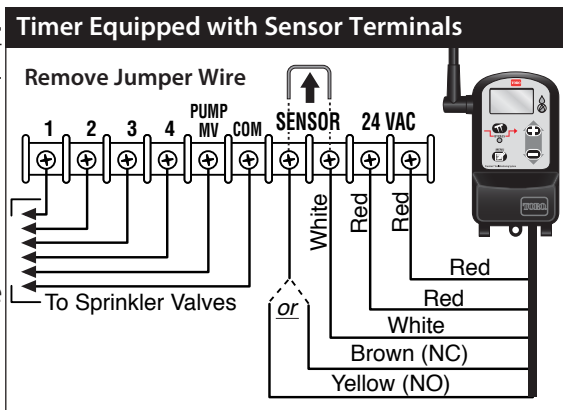

## 2. For a Normally Closed Sensor:

Remove the jumper wire, and connect the **Brown** and **White** wires to the Sensor terminals (in either position). *The Yellow wire is not used.*

## For a Normally Open Sensor:

Connect the **Yellow** and **White** wires to the sensor terminals (in either position). *The Brown wire is not used.*

## 3. Continue to Step 4 below.

## Setup for Timer Without Sensor

- 1a. Remove the wire(s) connected to the field Common terminal (labeled COM or C).

- 2a. Using a twist-on wire connector, attach the **Brown** wire to the wire(s) removed from the Common terminal. *The Yellow wire is not used.*

- 3a. Attach the **White** wire to the Common (COM) terminal.

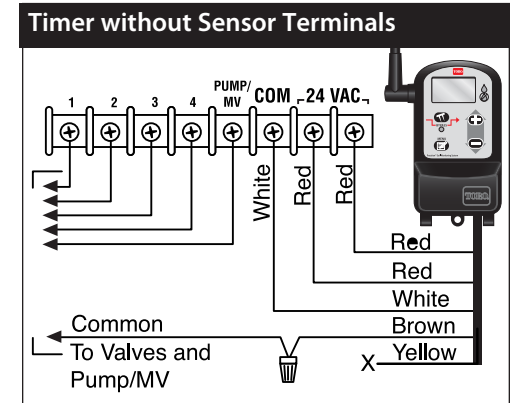

## Common Setup (continued)

4. Attach the **Red** wires to the timer's 24 VAC power terminals.

**⚠ Caution:** The receiver requires a source of 24 VAC continuous power for operation. Severe damage will result if wired directly to 110/120 VAC.

5. Apply power to the timer.

**Note:** When the receiver is initially powered up, the green LED will light, and the display will show two bars with alternating Signal and Battery symbols.

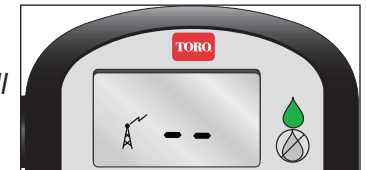

## Adjust Watering Program

Review the timer's automatic watering program and adjust as necessary to provide the following watering schedule:

- Set watering to run every day of the week – *with the exception of restricted watering days.*
- Set a run time duration for each zone that will provide thorough watering – *without causing pooling or runoff.*
- Ensure an automatic watering cycle will run within 16 hours after initial installation of the Precision Soil Sensor.



## Select the Sensor Installation Site

Choosing the right location for the sensor is very important for the overall effectiveness of the Precision Soil Sensor system.

The illustration below represents a typical residential landscape. The blue sections indicate the areas that will receive the most direct sunlight throughout the day and may be considered for sensor placement.

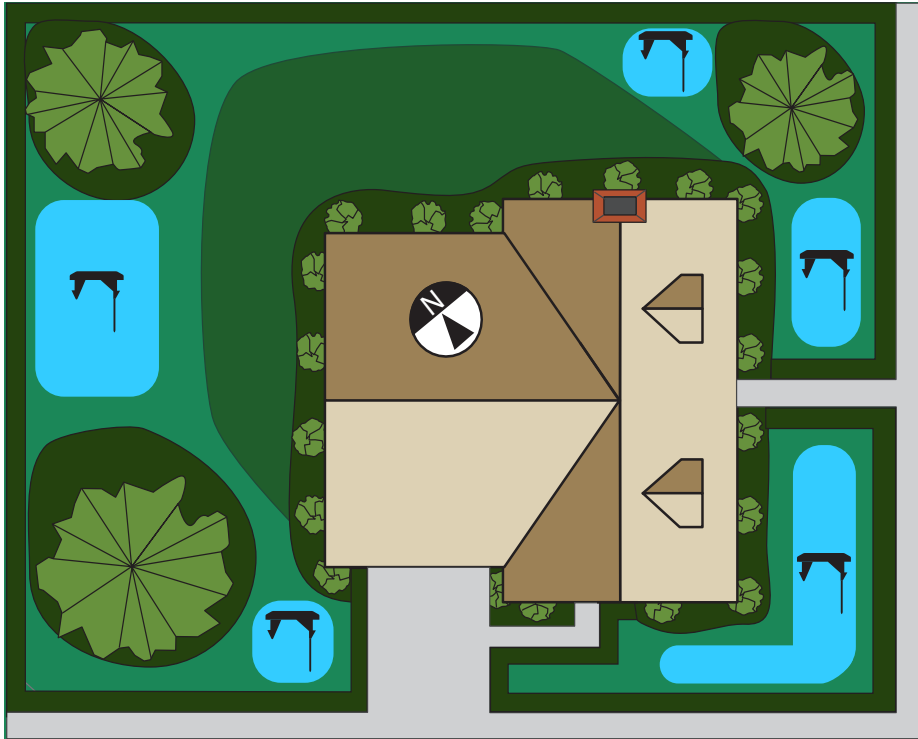

From among the prospective lawn areas, select an installation site with the following characteristics

- Is representative of the overall soil type and condition
- Is the highest elevation
- Is not over a septic tank or drain field
- Is well within receiver communication range (500' line-of-sight)
- Is at least 4 feet away from a driveway, roof overhang or downspout
- Is not in a footpath or recreational area
- Is not exposed to overspray from nearby watering zones

## Install Sensor Batteries

- Remove four stainless Phillips screws securing the sensor battery compartment cover. Place cover aside.

**Note:** The sensor requires three size AA alkaline batteries for operation. Batteries are not included.

- Install the batteries as shown.
- Install the battery compartment cover.

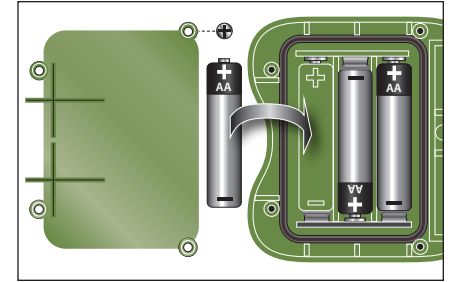

**Note:** When the sensor batteries are initially installed, the LED signal indicator is Red. When the receiver links with the sensor, the LED changes to Green. The LED will remain on for 30 minutes to facilitate sensor installation.

## Install Sensor

- Move the sensor to the proposed installation site. Signal strength is indicated by the LED color as follows:

- Green = Excellent
- Yellow = Acceptable
- Red = Not Acceptable - Relocate Sensor

- With a suitable installation site selected, thoroughly irrigate the sensor location and surrounding landscape area by running a manual watering cycle.
- Trim the grass close to ground level where the sensor will be placed.

**⚠ Caution:** For close-cut turf varieties, such as Hybrid Bermuda, the top of the sensor must be installed at grade level to prevent damage by mowing equipment.

- Applying even, downward pressure on top of the sensor, insert the sensor probes and retention spikes completely into the soil.
- At the receiver, press the **Bypass**  to place the Precision Soil Sensor in the Normal Operating mode.

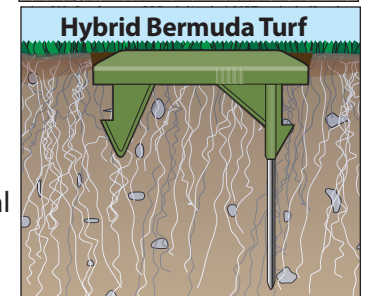
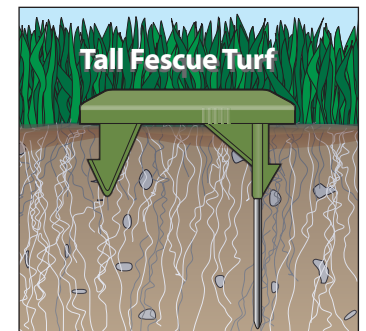
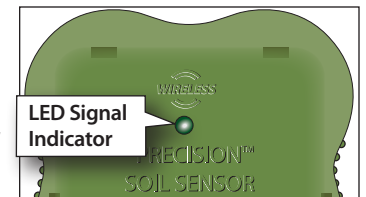

## Troubleshooting

### Solving Reception Problems

The Precision Soil Sensor system operates under Part 15 of the FCC rules. This means that it has to comply with certain standards and is only allowed to transmit up to a certain power level. In rating transmitters of any form, typically a Line-of-Sight (LOS) value is used to show the relative effectiveness of a transmitter and allow a transmitter and receiver to be compared to one another using a fair (apples to apples) method. The Precision Soil Sensor has an effective operating range up to 500 feet LOS - meaning in an open field, with no obstructions, the system will have a successfully communication range of up to 500 feet. However, in almost all installations, there are obstacles between the sensor and receiver such as walls, floors, etc. These obstacles will affect the signal reception and typically reduce the radiated signal strength sent to the receiver. Different objects affect the transmitted signal differently depending on the construction material, geometry, and size. Typically, most residential construction materials do not reduce the effective transmitted signal enough to pose problems under normal installation conditions. However there are some indoor installations with very thick walls, or where radio frequency interference is high due to a nearby pump motor or large electrical appliance.

To help resolve wireless communication problems:

- Install the sensor as close to the receiver location as possible to reduce the potential for interference and signal reduction. If the signal strength is not good in one location, try another appropriate location nearby - just moving the sensor a few feet can greatly improve signal strength.
- Interior locations where cell phones or cordless phones have trouble with reception may indicate areas with poor RF signal transmission. The receiver can be installed outdoors and connected to the timer with extended wire leads.

## Specifications

### Receiver

- Receiver Mounting Options: Indoor or Outdoor (stainless steel screws and double sided tape provided)
- Operating Temperature: 14° F –140° F
- Receiver Connection Cable: 36", 24 AWG, 5-conductor, color-coded cable
- Receiver Power Input: 22–28 VAC/VDC, 100mA, from existing timer with Class 2, UL-approved transformer
- Output Relay Contacts: Normally Open (NO) and Normally Closed (NC), 3A @ 24 VAC
- Receiver Material: High-impact ABS
- Operating Frequency: 915Mhz, DSSS (Direct Sequence Spread Spectrum)
- Agencies Approvals: UL and FCC

### Sensor

- Power Supply: 4.5 VDC supplied by three size-AA alkaline batteries
- Housing Material: High-impact ABS
- Moisture Protection: Electronic circuitry encased in solid epoxy; battery compartment sealed by O-ring
- Signal Quality Indicator: Tri-colored (Red, Yellow, Green) LED
- Stainless steel electrodes
- Built-in installation anchor stakes

## Toro Commitment to Quality - Warranty

### Toro Commitment to Quality

Toro is committed to developing and producing the highest quality, best performing, most dependable products on the market. Because your satisfaction is our first priority, we have provided the Toro Helpline to assist you with any questions or problems that may arise. If for some reason you are not satisfied with your purchase or have questions, please contact us toll free at 1-800-367-8676.

### Warranty

The Toro Company and its affiliate, Toro Warranty Company, pursuant to an agreement between them, jointly warrants, to the owner, against defects in material and workmanship for a period of one year from the date of purchase.

Neither The Toro Company nor Toro Warranty Company is liable for failure of products not manufactured by them, even though such products may be sold or used in conjunction with Toro products.

During such warranty period, we will repair or replace, at our option, any part found to be defective.

Return the defective part to the place of purchase.

Our liability is limited solely to the replacement or repair of defective parts. There are no other express warranties.

This warranty does not apply where equipment is used, or installation is performed, in any manner contrary to Toro's specifications and instructions, nor where equipment is altered or modified.

Neither The Toro Company nor Toro Warranty Company is liable for indirect, incidental or consequential damages in connection with the use of equipment, including but not limited to: vegetation loss, the cost of substitute equipment or services required during periods of malfunction or resulting non-use, property damage or personal injury resulting from installer's negligence.

Some states do not allow the exclusion or limitation of incidental or consequential damages, so the above limitation or exclusion may not apply to you.

All implied warranties, including those of merchantability and fitness for use, are limited to the duration of this express warranty.

Some states do not allow limitations of how long an implied warranty lasts, so the above limitation may not apply to you. This warranty gives you specific legal rights and you may have other rights which vary from state to state.

## FCC Part 15 Rules









This equipment has been tested and found to comply with the limits for a Class B digital device, pursuant to Part 15 of the FCC Rules. These limits are designed to provide reasonable protection against harmful interference in a residential installation. This equipment generates, uses and can radiate radio frequency energy and, if not installed and used in accordance with the instructions, may cause harmful interference to radio communications. However, there is no guarantee that interference will not occur in a particular installation. If this equipment generates interference to radio or television reception, which can be determined by turning the equipment on and off, the user is encouraged to try to correct the interference by one or more of the following measures:

1. Reorient or relocate the receiving antenna.
2. Increase the separation between the equipment and receiver.
3. Connect the equipment into an outlet on a circuit different from that to which the receiver is connected.
4. Consult the dealer or an experienced radio/TV technician for help.

The user may find the following booklet prepared by the Federal Communications Commission helpful: "How To Identify and Resolve Radio-TV Interference Problems". This booklet is available from the U.S. Government Printing Office, Washington, DC 20402. Stock No. 004-000-00345-4

 *The table below is provided to use as a quick reference guide for the various Precision Soil Sensor menu options. Simply clip out and tape next to receiver or inside the timer cover (if applicable).*

Press and release the Menu  button to step through the menu sequence.

	Precision System Menu Item	Default Setting	Range
	System Calibration Mode	Automatic	Manual Reset
	Watering Completion Time	4 Hours	0–24 Hours
	Smart Bypass Timer	24 Hours	1–199 Hours
	Freeze Shut-off Mode Temp	39°F	35–45°F (2–7°C)
	Signal Strength Indicator	Review Only	0.0–10.0+
	Battery Voltage Indicator	Review Only	0.0–4.5+
	Sensor Identification Code	Review Only	00 00 00–99 99 99
	Temperature Format Indicator	°F	°F or °C
	Sensor Temperature	Review Only	14° F –140° F+





