

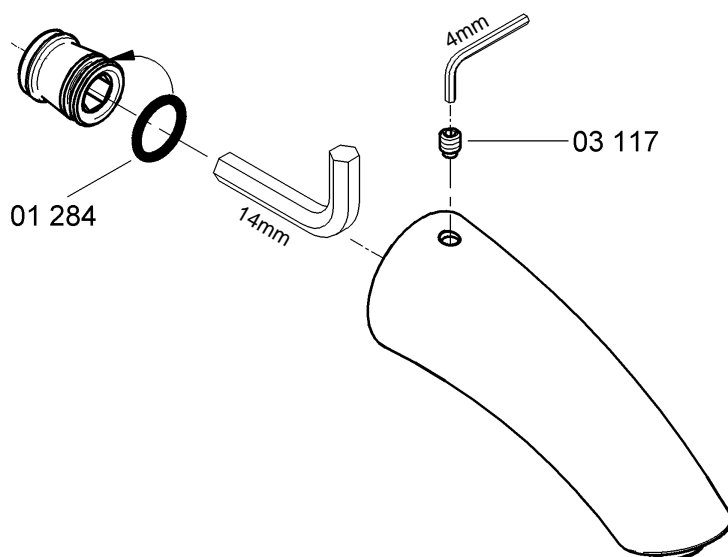

WATER TECHNOLOGY

28 535

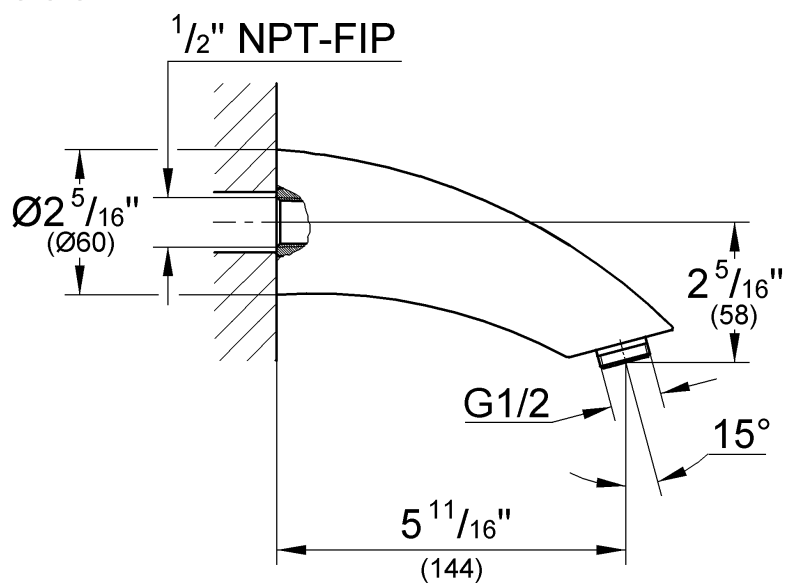



WATER TECHNOLOGY

