

Note: Twist Lock Pipe (6"-12") overlaps 1½" when joined together. Quick Connect Lock (14"-18") overlaps 1½" when joined together with sheet metal screws. Therefore, assembled length on all sizes is 1½" less than listed length.

**Temp/Guard® All-Fuel Chimneys**

Double-wall, factory-built type for use with listed wood, coal, oil or gas-fired appliances.



- Temp/Guard Max is the only all-fuel chimney that is UL Listed for 1½" clearance to combustibles on 6", 7", and 8" diameters.
- Temp/Guard (10"-18") is tested and listed for a minimum clearance to combustibles of 2".
- Sizes 6", 7", 8", 10" and 12" are listed by Underwriters Laboratories Inc. to UL Standard 103HT (2100° intermittent; 1000° continuous).
- Sizes 14", 16" and 18" are listed by Underwriters Laboratories Inc. to UL Standard 103 (1700°F intermittent; 1000°F continuous).
- Sizes 6", 7" and 8" are listed by Underwriters Laboratories Inc. to ULC-S629 for use in Canada (see separate installation instructions; literature number L2686).
- The S.S. flue conduit is wrapped with ceramic insulating material.
- Limited Lifetime Warranty



- **Application Reminder:** For oil or coal burning appliances, use only pipe with S.S. casing and S.S. or Aluminum accessory components outside the envelope of the building.
- **Appliance Caution:** Temp/Guard is intended for use in residential and building heating appliances that operate at continuous temperatures below 1000° F.

**CHIMNEY PIPE – 6" - 12" TGS (Stainless Casing) and TGG (Galvanized Casing)**

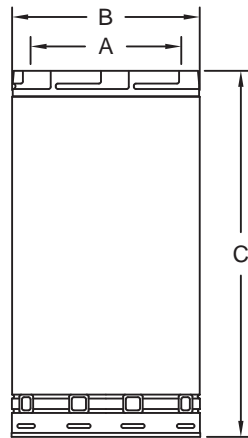

SIZE	6"	7"	8"	10"	12"
A	6.00"	7.00"	8.00"	10.00"	12.00"
B	9.00"	10.00"	11.00"	13.00"	15.00"
C	6, 12, 18, 24, 36, and 48* inch lengths				

\*48" lengths of 10" and 12" not available

The outer casing of stainless or galvanized provides strength, durability, and corrosion resistance. Twist lock enables fast, easy installation, without tools. **Always use TGS for exterior pipe in oil applications.**

**CHIMNEY PIPE – 14" - 18" TG (Aluminized Outer Casing)**

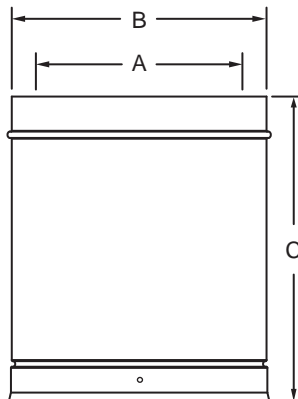

- Notes:
- (1) 14", 16", 18" listed to 1700°F intermittent; 1000°F continuous.
  - (2) Quick Connect Lock using sheet metal screws.

SIZE	14"	16"	18"
A	14.00"	16.00"	18.00"
B	17.00"	19.00"	21.00"
C	12, 18, 36, & 48 inch lengths		

Note: Twist Lock Pipe overlaps 1½" when joined together. Therefore, assembled length is 1½" less than listed length.

**INSULATED TEE – 6" - 12" TGST (Stainless Casing) and TGGT (Galvanized Casing)**

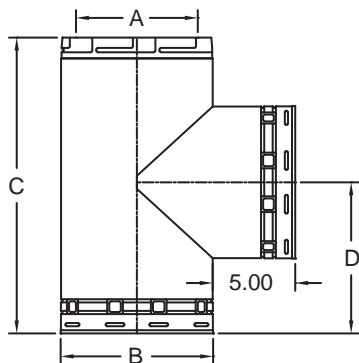

SIZE	6"	7"	8"	10"	12"
A	6.00"	7.00"	8.00"	10.00"	12.00"
B	9.00"	10.00"	11.00"	13.00"	15.00"
C	17.50"	18.50"	19.50"	21.50"	23.50"
D	9.50"	10.00"	10.50"	11.50"	12.50"

The chimney tee may be used to support the chimney indoors or outdoors on the non-combustible wall support or masonry pier. A standard tee cap (TGTC) ships with the tee.

Note: Insulated Tee - 10" - 12" galvanized casing only. 14", 16", and 18" components are intended for use on chimney extensions only.

**TEE CAP – 6" - 12" TGTC**



Ships with 6" - 12" tee, or may be ordered separately.

**INSULATED TEE CAP – 6" - 8" TGITC**

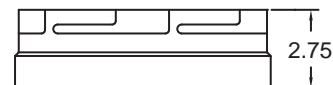

For installations close to combustibles, this insulated tee cap may be ordered separately. Not for use on a tee support.

**15° ANGLE – 6" - 12" TGSA15 (Stainless Casing) and TGA15 (Galvanized Casing)**

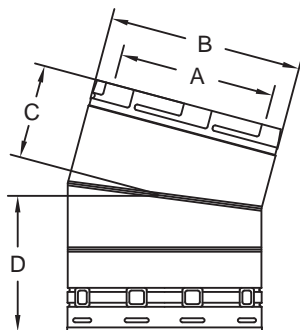

SIZE	6"	7"	8"	10"	12"
A	6.00"	7.00"	8.00"	10.00"	12.00"
B	9.00"	10.00"	11.00"	13.00"	15.00"
C	3.75"	3.75"	3.75"	3.75"	3.75"
D	6.40"	6.40"	6.40"	6.40"	6.40"

15° angles are used in pairs to obtain lateral movement around obstructions or to locate the chimney closer to the ridge.

15° angles in 10" & 12" available with galvanized casing only.

NOTE: See installation instructions for offset chart.

**15° ANGLE – 14" - 18" TGA15 (Aluminized Outer Casing)**

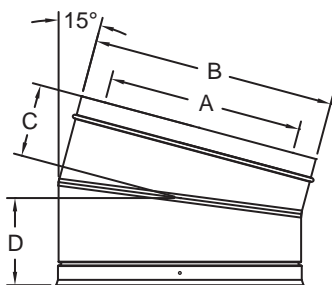

SIZE	14"	16"	18"
A	14.00"	16.00"	18.00"
B	17.00"	19.00"	21.00"
C	5.13"	5.25"	5.40"
D	6.13"	6.25"	6.40"

15° angles are used in pairs to obtain lateral movement around obstructions or to locate the chimney closer to the ridge.

NOTE: See installation instructions for offset chart.

Note: Twist Lock Pipe overlaps 1½" when joined together. Therefore, assembled length is 1½" less than listed length.

**30° ANGLE – 6" - 12" TGSA30 (Stainless Casing) and TGGA30 (Galvanized Casing)**

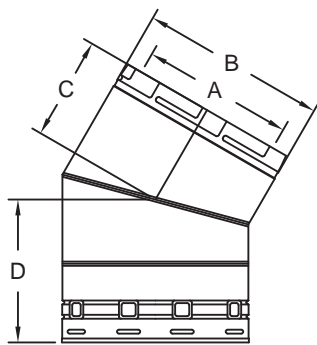

SIZE	6"	7"	8"	10"	12"
A	6.00"	7.00"	8.00"	10.00"	12.00"
B	9.00"	10.00"	11.00"	13.00"	15.00"
C	4.75"	4.75"	4.75"	4.75"	4.75"
D	6.75"	6.75"	6.75"	6.75"	6.75"

30° angles are used in pairs to obtain lateral movement where more angle is required.

**30° ANGLE – 14 - 18" TGA30 (Aluminized Outer Casing)**

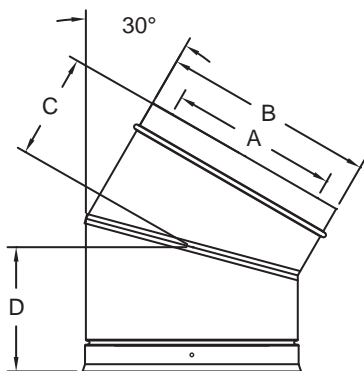

SIZE	14"	16"	18"
A	14.00"	16.00"	18.00"
B	17.00"	19.00"	21.00"
C	6.25"	6.50"	6.81"
D	7.25"	7.50"	7.81"

30° angles are used in pairs to obtain lateral movement where more angle is required.

**PAINTED CEILING SUPPORT – TGCSP**

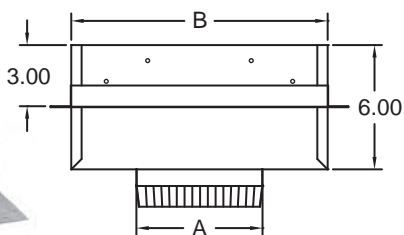
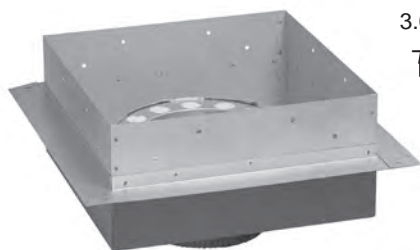

SIZE	6"	7"	8"	10"	12"
A	6.00"	7.00"	8.00"	10.00"	12.00"
B	12.44"	13.44"	14.44"	17.00"	19.00"
Flange Width is 1½"					

The black ceiling support is designed to support the chimney from the floor or ceiling joists. 6", 7", and 8" chimney fits between 16" O.C. joists with required clearance. Single wall adapter is part of support assembly.

**PAINTED CEILING SUPPORT TRIM – TGCST**

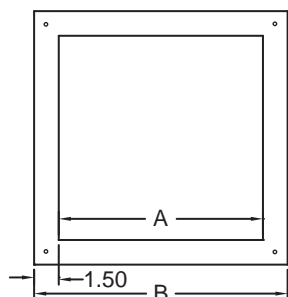

SIZE	6"	7"	8"	10"	12"
A	12.63"	13.63"	14.63"	17.19"	19.19"
B	15.63"	16.63"	17.63"	20.19"	22.19"

The black trim piece is used to trim off the ceiling support (TGCSP) if ceiling drywall has covered the built-in support box trim on new construction.

**DELUXE CEILING SUPPORT – 6" and 8" TGDLS**

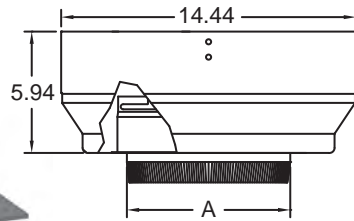

SIZE	6"	8"
A	6.00"	8.00"

The deluxe support provides round "barrel" design. The "barrel" has Temp/Guard pipe adapter built into it. Comes with both round and square trim plates (square plate shown).

**WALL SUPPORT/ADAPTER – FIXED – TGWS**

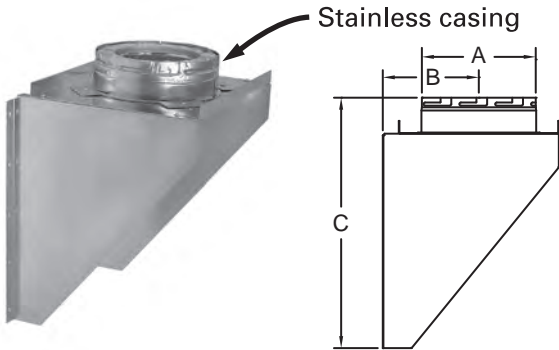

SIZE	6"	7"	8"	10"	12"
A	9.00"	10.00"	11.00"	13.00"	15.00"
B	6.50"	7.00"	7.50"	8.50"	9.50"
C	16.50"	16.50"	16.50"	20.50"	20.50"

Mounting spacing is 16" O.C. for all sizes. This fixed spacing wall support is designed for use with the insulated tee to provide support for the chimney which has a lateral connection passing through the combustible wall. Support allows access from below to tee cap. The maximum height of chimney which may be supported is 60 ft.

Note: Available in stainless steel, please contact factory.

**WALL SUPPORT/ADAPTER – ADJUSTABLE – TGAWS**

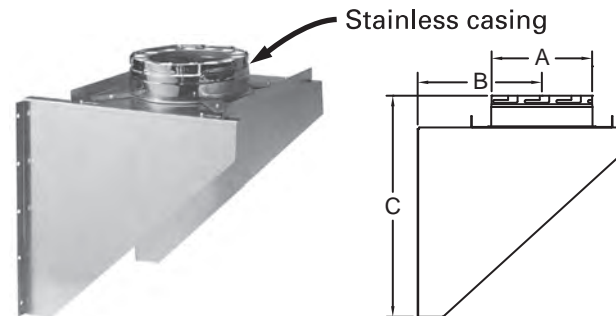

SIZE	6"	7"	8"
A	9.00"	10.00"	11.00"
B	5.00"-11.00"	5.00"-11.50"	5.00"-13.50"
C	19.50"	19.50"	19.50"

The adjustable support enables adjustments in clearance to combustibles from 2" - 8.50".

Note: Available in stainless steel, please contact factory.

**ANCHOR PLATE – 6" - 12" TGAP**

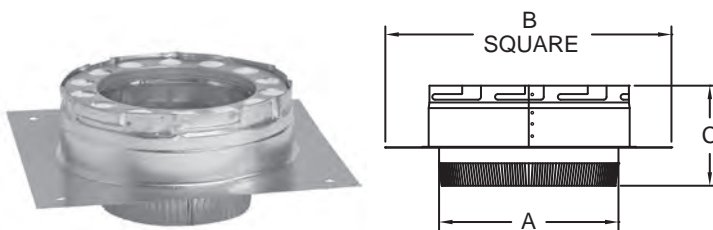

SIZE	6"	7"	8"	10"	12"
A	6.00"	7.00"	8.00"	10.00"	12.00"
B	12.00"	13.00"	14.00"	16.00"	18.00"
C	4.75"	4.75"	4.75"	3.75"	3.75"

The stainless steel anchor plate provides a positive connection to the smoke chamber on top of the masonry fireplace. 6" - 12" also used with chimney tee on masonry pier.

**ANCHOR PLATE – 14" - 18" TGAP**

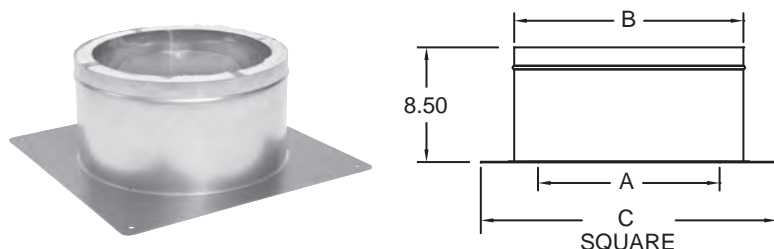

SIZE	14"	16"	18"
A	14.00"	16.00"	18.00"
B	17.00"	19.00"	21.00"
C	22.00"	24.00"	26.00"

**SUPPORT BAND – 6" - 16" TGSB**

Note: Use with TG and ATG

SIZE	6"	7"	8"	10"	12"	14"	16"
A	9.00"	10.00"	11.00"	13.00"	15.00"	17.00"	19.00"

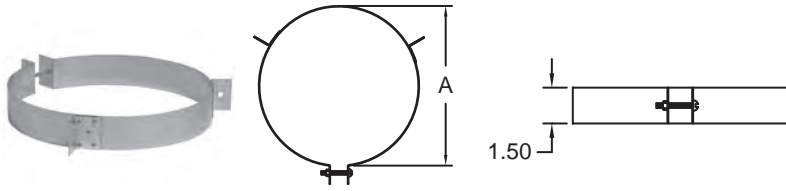

The support band is for use on installations where additional support is needed above the roof. Thin wall conduit or guy wire is to be attached to the band.

Note: Available in stainless steel, please contact factory.

**ROOF BRACE – 6" - 8" TGRB**

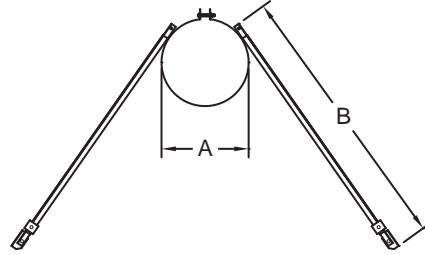

SIZE	6"	7"	8"
A	9.00"	10.00"	11.00"
B	Adjustable from 32" to 60"		

The roof brace kit includes support band, two braces, and mounting feet. Needed when more than 4 ft. of chimney extends above the roof.

**WALL BAND – 6" - 18" TGWB**

Note: Use with TG and ATG

SIZE	6"	7"	8"	10"	12"	14"	16"	18"
A	9.00"	10.00"	11.00"	13.00"	15.00"	17.00"	19.00"	21.00"
B	6.50"	7.00"	7.50"	8.50"	9.50"	10.50"	11.50"	12.50"
C	16.00"	16.00"	16.00"	16.00"	17.50"	18.00"	20.00"	22.00"

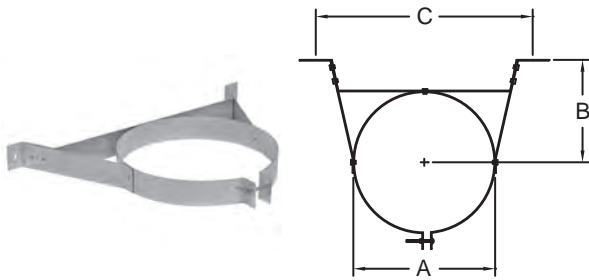

The wall band is used to secure the chimney to the wall, providing lateral stability and maintaining the proper clearance for the chimney pipe. The recommended spacing is 8 ft. between bands above the starting point.

Note: Available in stainless steel, please contact factory.

**WALL BAND ADJUSTMENT KIT – TGWBA – KIT FITS 6", 7" AND 8"**

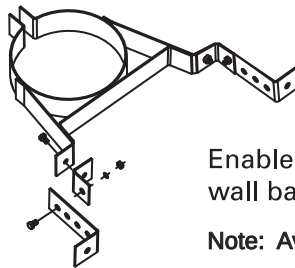

Enables adjustment of standard wall band (TGWB) from 2" - 6"

Note: Available in stainless steel, please contact factory.

**ROOF SUPPORT W/TRIM – 6" - 12" TGRS**

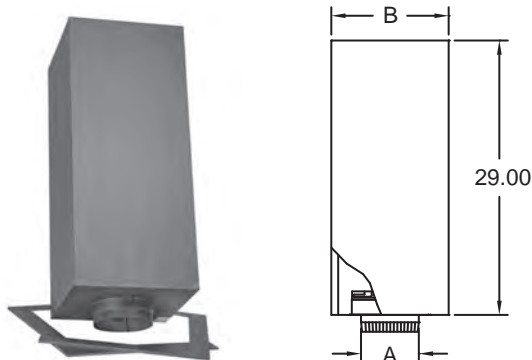

SIZE	6"	7"	8"	10"	12"
A	6.00"	7.00"	8.00"	10.00"	12.00"
B	12.44"	13.44"	14.44"	17.00"	19.00"

For use on open beamed pitched roofs or ceilings. Includes trim pieces for finishing out installation. Also includes integral single wall adapter. Will support 20 ft. of pipe.



**ADJUSTABLE SUPPORT – 6" - 12" TGAS**

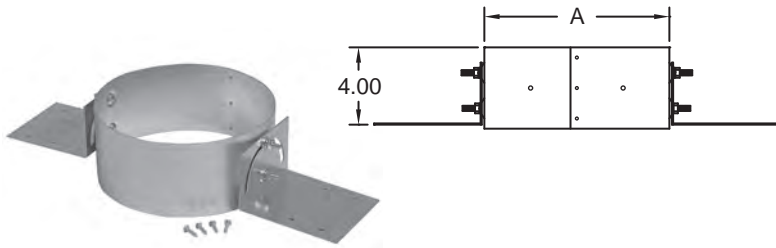

SIZE	6"	7"	8"	10"	12"
A	9.10"	10.10"	11.10"	13.10"	15.10"

Adjustable support fits all roof pitches and requires only simple framing. Can support 30 ft. of pipe. Trim with pitched ceiling plate of correct pitch.

**PITCHED CEILING PLATE – 6" - 8" TGPCP**

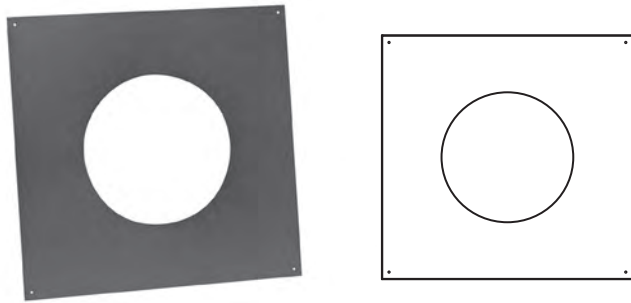

Used when pipe is supported by the TGAS. The oval I.D. of this plate covers any gap left between the chimney pipe and the ceiling. Select the plate which corresponds with the ceiling pitch. I.D. sized to fit over trim sleeve (TGTS).

Available pitches:  
2/12; 4/12; 6/12; 8/12; & 10/12

**PAINTED TRIM SLEEVE – 6" - 8" TGTS**

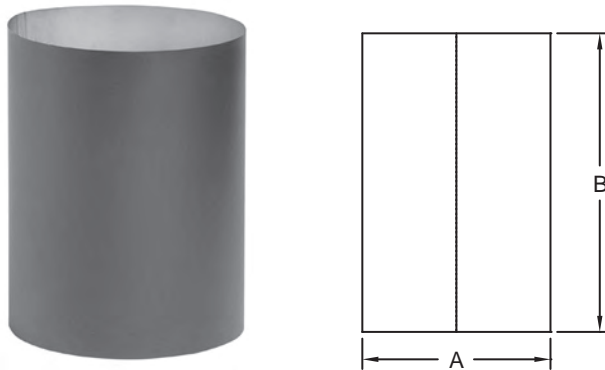

SIZE	6"	7"	8"
A	9.06"	10.06"	11.06"
B	12.00"	12.00"	12.00"

This cylinder slides over O.D. of TG pipe that protrudes through the wall or ceiling. It provides a uniform, finished appearance.

**SINGLE WALL ADAPTER – 6" - 8" TGPSWA (Painted) & 10" - 12" TGSWA (Unpainted)**

Also used as double wall black adapter.

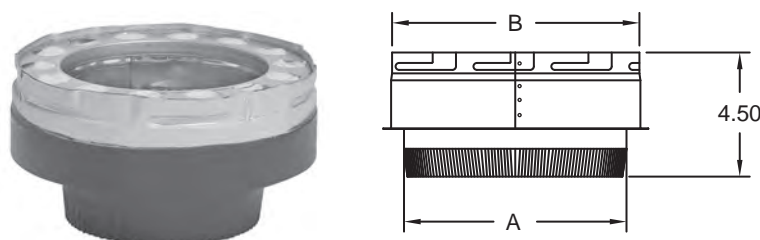

SIZE	6"	7"	8"	10"	12"
A	6.00"	7.00"	8.00"	10.00"	12.00"
B	9.00"	10.00"	11.00"	13.00"	15.00"

The single wall adapter is used to provide transition from single wall pipe to Temp/Guard chimney pipe.

\*10" & 12" are unpainted.

**FIRESTOP ASSEMBLY – TGFSA**

SIZE	6"	7"	8"	10"	12"	14"	16"	18"
A	15.88"	16.88"	17.88"	21.00"	23.00"	19.00"	21.00"	23.00"
B	12.94"	13.94"	14.94"	16.94"	18.94"	21.00"	23.00"	25.00"
C	1.00"	1.00"	1.00"	1.00"	1.00"	25.00"	27.00"	29.00"

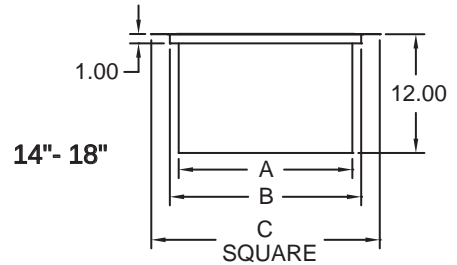
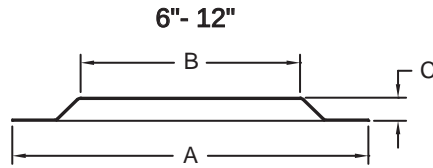

**WALL FIRESTOP – 6" - 12" TGWFSP**

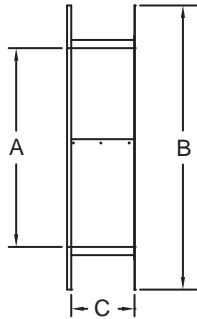

SIZE	6"	7"	8"	10"	12"
A	9.13"	10.13"	11.13"	13.13"	15.13"
B	17.00"	18.00"	19.00"	21.00"	23.00"
C	4.00" to 7.50"				

Wall firestop is used to provide the proper clearance for the chimney pipe when passing through a combustible wall.

**INSULATION SHIELD – 6" - 12" TGIS**

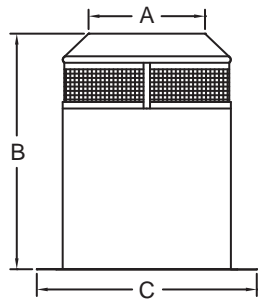

SIZE	6"	7"	8"	10"	12"
A	9.00"	10.00"	11.00"	13.00"	15.00"
B	18.00"	18.00"	18.00"	18.00"	18.00"
C	17.00"	18.00"	19.00"	21.00"	23.00"

Insulation shield must be used anytime the chimney system passes through an attic. TGIS is used to prevent the insulation from coming in contact with the pipe. This part is required on **any** attic pass-through situation, regardless if insulation is present or not.

Note: 14" - 18" insulation shield is not available, attic installation is not intended for these sizes.

**RADIATION SHIELD – 8" - 18" TGRSH**

Note: Use with TG and ATG

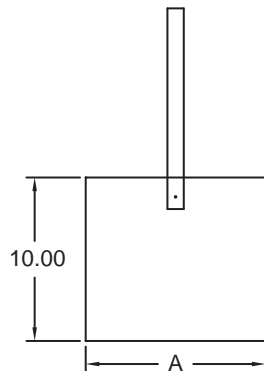

SIZE	8"	10"	12"	14"	16"	18"
A	13.00"	15.00"	17.00"	19.00"	21.00"	23.00"

12"-18"

Used on Temp/Guard

8"-16"

Used on Air-Cooled Temp/Guard

Radiation shield is required when 12" and larger diameter chimney pipe passes through a roof.

Note: Available in stainless steel, please contact factory.

**STAINLESS CAP/SPARK ARRESTER – 6" - 12" TGC**

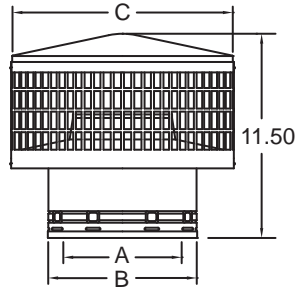

SIZE	6"	7"	8"	10"	12"
A	6.00"	7.00"	8.00"	10.00"	12.00"
B	9.00"	10.00"	11.00"	13.00"	15.00"
C	13.50"	13.50"	15.50"	19.13"	19.13"

The contemporary spark arrester cap also guards against rain, snow and down drafts, and helps provide proper venting action.

**STAINLESS CAP/ SPARK ARRESTER – 14" - 18" TGC**

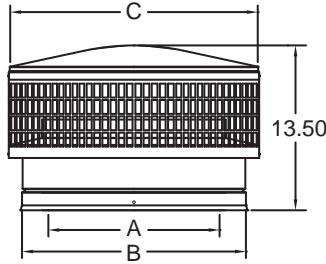

SIZE	14"	16"	18"
A	14.00"	16.00"	18.00"
B	17.00"	19.00"	21.00"
C	19.13"	21.00"	24.00"

**STAINLESS DETACHABLE CAP – 6" - 8" TGDC**

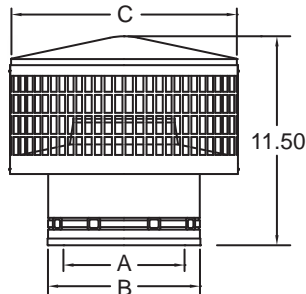

This cap is similar to TGC, but is produced without twist locking buttons. Cap slips onto pipe and is attached with packaged screws. Easily removed for cleaning. See TGC size chart.

**STAINLESS CAP (Rain Cap) – 6" - 12" TGRC**

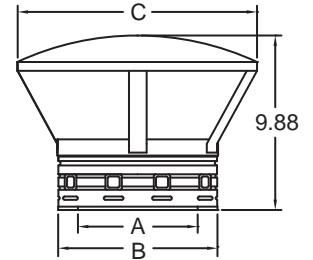

SIZE	6"	7"	8"	10"	12"
A	6.00"	7.00"	8.00"	10.00"	12.00"
B	9.00"	10.00"	11.00"	13.00"	15.00"
C	13.50"	13.50"	15.50"	19.13"	19.13"

**STORM COLLAR – 6" - 8" TGSC and TGASC (Aluminum)  
10" - 12" TGSC and TGSSC (Stainless)  
14" - 18" TGSC (Galvanized)**

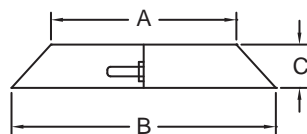

SIZE	6"	7"	8"	10"	12"	14"	16"	18"
A	9.00"	10.00"	11.00"	13.00"	15.00"	17.00"	19.00"	21.00"
B	18.00"	18.00"	19.50"	21.50"	23.50"	25.50"	27.50"	29.50"
C	3.18"	3.18"	3.18"	3.18"	3.18"	4.25"	4.25"	4.25"

Note: Aluminum or stainless steel materials are recommended for oil and coal applications.

**DEAD SOFT ALUMINUM FLASHING – 6" and 8" TGDSF**

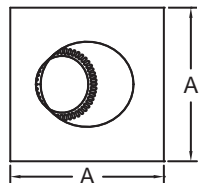

Fits roof pitch from 2/12 to 5/12

SIZE	6"	8"
A	22.25"	24.00"

For use with metal, corrugated and tile applications.