

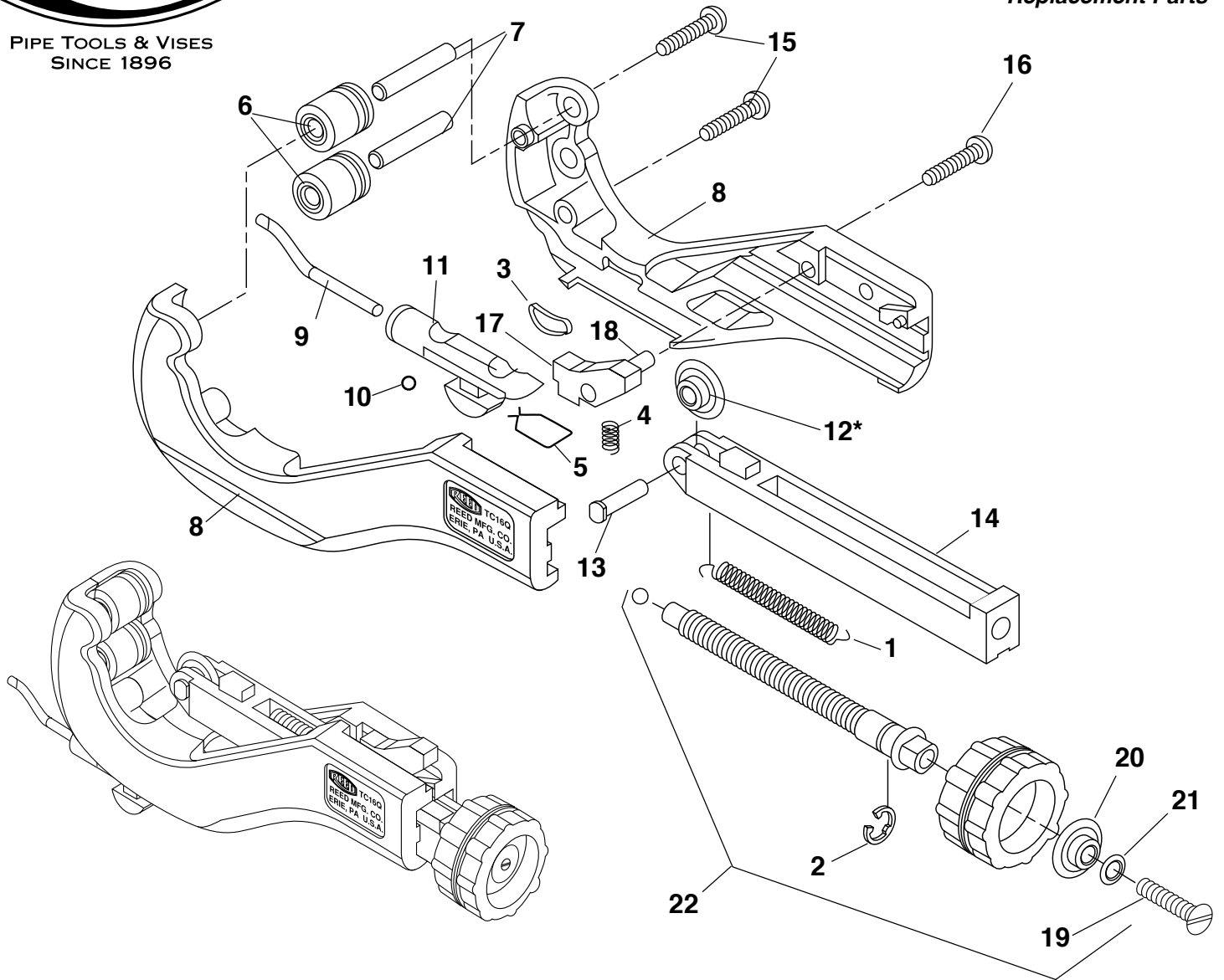

PIPE TOOLS & VISES
SINCE 1896

Quick Release™ Tubing Cutters (TC1.6Q models)

Replacement Parts



Parts List

Ref. No.	Description	Item Code	Qty. Used	Ref. No.	Description	Item Code	Qty. Used
1	Bar Spring	93630	1	12*	Cutter Wheel for Copper	03660	1
2	Retaining Ring	93433	1		Cutter Wheel For CSST	03659	1
3	Flat Spring	40440	1		Cutter Wheel For Plastic	04180	1
4	Zip Nut Spring	93440	1		Cutter Wheel For PVC	04184	1
5	Blade Retaining Spring	40437	1	13	Wheel Pin	93427	1
6	Roller	93628	2	14	Bar	93623	1
7	Roller Pin	40438	2	15	Assembly Screw/Nut End	30222	2
8	TC1.6Q Body Shell	93620	1	16	Assembly Screw/Roller End	30221	1
9	Burr Blade / Reamer	94437	1	17	Feed Nut	93407	1
10	Steel Ball	93447	1	18	Nut Pin	40439	1
11	Reamer Holder	93625	1	19	Screw	93449	1
				20	Extra Cutter Wheel	—	1
				21	Washer	93434	1
				22	Knob & Screw Assembly	93635	1

Reed Manufacturing
1425 West 8th Street
Erie, PA 16502 USA



Phone: 800-666-3691 or +1-814-452-3691
reedsales@reedmfgco.com
www.reedmfgco.com

RP-0821-35