



SERVICE PARTS LIST

BULLETIN NO.
54-40-6120

SPECIFY CATALOG NO. AND SERIAL NO. WHEN ORDERING PARTS		REVISED BULLETIN	DATE
JIG SAW			Aug. 2013
CATALOG NO.	6278-20	SERIAL NUMBER	C56A
		WIRING INSTRUCTION See Pages 2 & 3	

EXAMPLE:
Component Parts (Small #)
Are Included When Ordering
The Assembly (Large #).

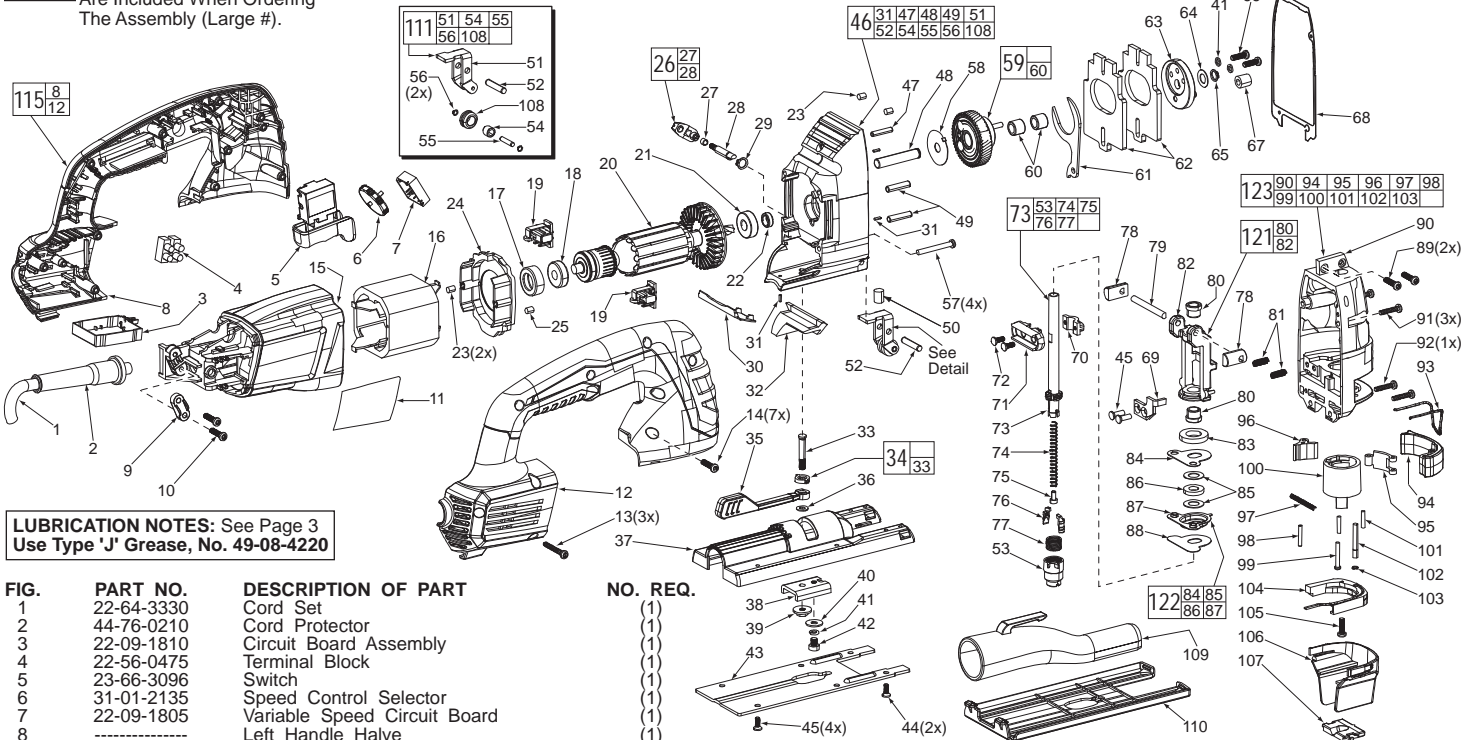

LUBRICATION NOTES: See Page 3
Use Type 'J' Grease, No. 49-08-4220

FIG.	PART NO.	DESCRIPTION OF PART	NO. REQ.
1	22-64-3330	Cord Set	(1)
2	44-76-0210	Cord Protector	(1)
3	22-09-1810	Circuit Board Assembly	(1)
4	22-56-0475	Terminal Block	(1)
5	23-66-3096	Switch	(1)
6	31-01-2135	Speed Control Selector	(1)
7	22-09-1805	Variable Speed Circuit Board	(1)
8	-----	Left Handle Halve	(1)
9	31-17-0195	Cord Clamp	(1)
10	05-88-5376	M4 x 12 Screw	(2)
11	12-20-6278	Service Nameplate	(1)
12	-----	Right Handle Halve	(1)
13	05-88-1300	M4 x 28 Screw	(3)
14	05-88-1200	M4 x 16 Screw	(7)
15	31-50-6000	Motor Housing	(1)
16	18-07-0230	Service Field	(1)
17	42-78-7030	Bearing Cup	(1)
18	02-04-6000	Ball Bearing	(1)
19	22-22-1560	Brush Assembly	(2)
20	16-07-0330	Service Armature	(1)
21	02-04-6001	Ball Bearing	(1)
22	45-36-7090	Spacer	(1)
23	44-86-0680	Rubber Bumper	(4)
24	31-05-6000	Baffle	(1)
25	44-68-0685	Rubber Pin	(1)
26	30-58-0105	Orbit Adjustment Lever Assembly	(1)
27	-----	Orbital Adjustment Stop	(1)
28	-----	Orbital Adjustment Shaft	(1)
29	34-60-0770	E-Ring	(1)
30	31-05-6001	Airflow Guide Plate	(1)
31	-----	Pin	(3)
32	42-68-0880	Clamping Claw	(1)
33	-----	Bolt	(1)
34	30-58-0125	Fixed Wedge Assembly	(1)
35	44-10-0700	Adjustable Base Lever	(1)
36	45-88-1990	Washer	(1)
37	28-06-1280	Base	(1)
38	31-17-0570	Base Clamp	(1)
39	05-59-0900	Fix Nut	(1)
40	45-88-2060	Washer	(1)
41	45-88-1890	Washer	(3)
42	05-81-1030	M4 x 9 Screw	(1)
43	42-92-1580	Slide Plate	(1)
44	05-88-1208	M4 x 13 Screw	(2)
45	05-81-1050	M4 x 10 Screw	(6)
46	28-14-6280	Gearcase/Blade Guide Assembly	(1)
47	-----	Pin	(1)
48	-----	Pin	(1)
49	-----	Pin	(2)
50	06-65-0420	5 x 9.6 Pin	(1)
51	-----	Blade Guide Holder	(1)
52	06-65-0410	5 x 24 Pin	(1)
53	-----	Blade Clamp Sleeve	(1)
54	-----	Needle Bearing	(1)
55	-----	Pin	(1)
56	42-70-0525	E-Ring	(2)
57	06-81-5376	M4 x 34 ST Screw	(4)
58	45-88-3070	Washer	(1)
59	32-30-0205	Output Gear Assembly	(1)
60	-----	Needle Bearing	(2)
61	44-66-1630	Drive Plate	(1)
62	42-28-0500	Balance Block	(2)
63	44-66-1510	Eccentricity Plate	(1)
64	45-88-3071	Washer	(1)
65	34-60-0750	E-Ring	(1)

FIG.	PART NO.	DESCRIPTION OF PART	NO. REQ.
66	05-88-1206	M4 x 12 Screw	(2)
67	02-50-1260	Needle Bearing	(1)
68	43-44-0611	Gasket	(1)
69	44-66-1290	Pressing Plate	(1)
70	45-98-0405	Cover Plate	(1)
71	45-98-0400	Connecting Link	(1)
72	05-88-1204	M3.5 x 10 Screw	(2)
73	38-50-0755	Spindle Assembly	(1)
74	-----	Spring	(1)
75	-----	M2.5 x 10 Screw	(1)
76	-----	Clamp Plate	(2)
77	-----	Spring	(1)
78	44-74-0170	Pivot Post	(2)
79	06-65-0310	Pin	(1)
80	-----	Sleeve Bearing	(2)
81	40-50-0780	Spring	(2)
82	-----	Spindle Guide	(1)
83	45-06-1205	Fiber Seal	(1)
84	-----	Oil Cover Plate	(1)
85	-----	Washer	(2)
86	-----	Fiber Seal	(1)
87	-----	Oil Rear Plate	(1)
88	45-06-1210	Rubber Seal	(1)
89	05-78-5313	M4 x 9 ST Screw	(2)
90	-----	Gearcase Cover	(1)
91	05-81-1040	M4 x 18 Screw	(3)
92	05-88-1210	M4 x 9 Screw	(1)
93	43-54-0780	Wire Guard	(1)
94	-----	Lever	(1)
95	-----	Link Rod	(1)
96	44-10-0690	Sleeve Lever	(1)
97	40-50-4410	Spring	(1)
98	-----	Pin	(1)
99	-----	M3 x 22 Screw	(1)
100	45-22-0190	Rotate Sleeve	(1)
101	-----	2.5 x 14 Pin	(2)
102	-----	3.2 x 30 Pin	(1)
103	-----	E-Ring	(1)
104	31-15-2215	LED Holder	(1)
105	06-82-5266	Screw	(1)
106	31-15-2210	Chip Shield	(1)
107	43-84-1030	Splinter Guard	(1)
108	-----	Blade Roller Guide	(1)
109	31-03-0065	Vacuum Attachment	(1)
110	31-15-0690	Base Plate	(1)
111	42-36-0281	Blade Guide Assembly	(1)
115	31-44-2376	Handle Assembly	(1)
121	42-40-1160	Saw Bar Guide/Sleeve Assembly	(1)
122	45-06-1030	Oil Cover Assembly	(1)
123	28-14-6285	Gearcase Cover/Release Lever Assy.	(1)