

EEMAX “FOUR MODULE, SINGLE PHASE” WATER HEATERS

ELECTRIC INSTANTANEOUS WATER HEATER INSTALLATION GUIDE AND OWNERS MANUAL

MODELS COVERED:- EX380T2T2 -208/240 V

EX380T4 - 208/240 V

SPECIAL _____, _____ V

WARNING

READ THE GENERAL SAFETY SECTION BEGINNING ON THE INSIDE COVER AND THEN THIS ENTIRE MANUAL BEFORE INSTALLING OR OPERATING THIS WATER HEATER. IF YOU DON'T FOLLOW THE SAFETY RULES, THE UNIT WILL NOT OPERATE PROPERLY AND IT COULD CAUSE DEATH, SERIOUS BODILY INJURY AND/OR PROPERTY DAMAGE. READ ALSO THE ENCLOSED WARRANTY CARD. WARRANTY OF THIS WATER HEATER WILL DEPEND ON PROPER INSTALLATION AND OPERATION. THE WARRANTY SHALL BE VOID IF THE DESIGN HAS BEEN ALTERED IN ANY WAY WHATSOEVER. THE MANUFACTURER OF THIS HEATER WILL NOT BE LIABLE FOR ANY DAMAGES BECAUSE OF FAILURE TO COMPLY WITH THE INSTALLATION AND OPERATING INSTRUCTIONS OUTLINED ON THE FOLLOWING PAGES.

THE INSTALLATION MUST CONFORM WITH THE INSTRUCTIONS IN THIS MANUAL; ELECTRIC COMPANY RULES; AND THE LOCAL CODES, OR IN THE ABSENCE OF LOCAL CODES, WITH THE LATEST EDITION OF THE NATIONAL ELECTRICAL CODE. THIS PUBLICATION IS AVAILABLE FROM YOUR LOCAL GOVERNMENT OR PUBLIC LIBRARY OR ELECTRIC COMPANY OR BY WRITING UNDERWRITERS LABORATORIES, 333 PFINGSTEN ROAD NORTHBROOK, IL, 60062.

IF YOU REQUIRE ANY HELP OR HAVE ANY QUESTIONS RELATING TO THE INSTALLATION OR PERFORMANCE OF THIS HEATER, PLEASE CALL OUR TECHNICAL SERVICE DEPARTMENT TOLLFREE : 1-800-543-6163.
HAVE THE INFORMATION LISTED BELOW BEFORE CALLING :

SERIAL NO. _____ MODEL NO. EX380 _____ INSTALLATION DATE _____

GENERAL SAFETY

The “Eemax Four Module, Single Phase” heater is specifically designed to take in cold water and heat it to temperatures suitable for normal domestic usage up to a maximum of 140 F(60 C). To obtain optimum performance and energy savings, the unit should be located as near as possible to the point of use. “Thermostatic” models indicated by the letters “T2T2 or T4” after the model number, these models and only these, can be fed with pre-heated water and be used to boost temperature

The unit is supplied with 3/4” NPT pipe connections. Under no circumstances use a blow torch on pipe which is connected to the heater (serious damage to the electronic flow switch will result). Carefully use Teflon tape, ensuring no debris enter the heater. **Do not use pipe dope.**

Also, ensure that the pipes are clear of installation debris before fitting the heater.

THIS HEATER MUST HAVE FOUR DEDICATED INDEPENDENT 240V or 208V CIRCUITS, USING CORRECTLY RATED WIRES AND CIRCUIT BREAKERS.

WARNING

FAILURE TO **GROUND** THE SYSTEM MAY RESULT IN DEATH OR SERIOUS INJURY.

WARNING

IMPROPER INSTALLATION, ADJUSTMENT, ALTERATION, SERVICE OR MAINTENANCE CAN CAUSE **DEATH, SERIOUS BODILY INJURY OR PROPERTY DAMAGE**. REFER TO THIS MANUAL FOR ASSISTANCE OR CONSULT THE LOCAL ELECTRIC UTILITY FOR FURTHER INFORMATION.

WARNING

WATER HEATERS EQUIPPED FOR ONE VOLTAGE ONLY: THIS WATER HEATER MAYBE EQUIPPED FOR ONE VOLTAGE TYPE ONLY: CHECK THE RATING PLATE ON THE FRONT COVER OF UNIT FOR THE CORRECT VOLTAGE. DO NOT USE THIS WATER HEATER WITH ANY OTHER VOLTAGE OTHER THAN THE ONE SHOWN ON THE MODEL RATING PLATE. FAILURE TO USE THE CORRECT VOLTAGE CAN CAUSE PROBLEMS WHICH CAN RESULT IN DEATH, SERIOUS BODILY INJURY, OR PROPERTY DAMAGE. IF YOU HAVE ANY QUESTIONS OR DOUBTS CONSULT EEMAX OR YOUR ELECTRIC COMPANY.

WARNING

HAZARD OF ELECTRICAL SHOCK! BEFORE REMOVING THE COVER OR SERVICING THE WATER HEATER, MAKE SURE THE ELECTRICAL SUPPLY TO THE WATER HEATER IS TURNED “OFF”. FAILURE TO DO THIS COULD RESULT IN **DEATH, SERIOUS BODILY INJURY, OR PROPERTY DAMAGE**.

I. MOUNTING THE UNIT

1) The unit should be mounted as close to the point of use as possible.

Do not install the heater above a faucet or “point of use” because the siphoning effect may drain the heater which can cause premature element burn out.

2) This unit must only be mounted in a vertical position with the **water fittings located at the bottom of the unit**. Mounting other than in the vertical position **WILL** cause element burn out and cause permanent damage to the water heater.

3) The cold water inlet is on the right hand side and the hot water outlet is on the left hand side. Under **NO** circumstances can these be reversed.

4) Leave a minimum of 8” above the unit for easy replacement of the element.

5) The heater should be fixed to the wall using all four mounting holes of the backplate. Unit weight is approximately 15 lbs. Use an appropriate fastener for this weight. For the unit to be mounted against hollow walls, suggest using steel wall anchors, with the correct grip range and #6-32 screw size minimum.

NOTE: The heater should be installed below the level of all hot water outlets serviced by this heater.

NOTE: PRESSURE AND TEMPERATURE RELIEF VALVE

These units are not required by UL to have a Pressure and Temperature Relief Valve (PTRV). You should check with local codes to find out if one is required in your area. If local codes require the use of a temperature and pressure relief valve it should be installed on the outlet hot water pipe before the outlet ball valve.

Figure 2

Showers and the whole house, cabin or condo

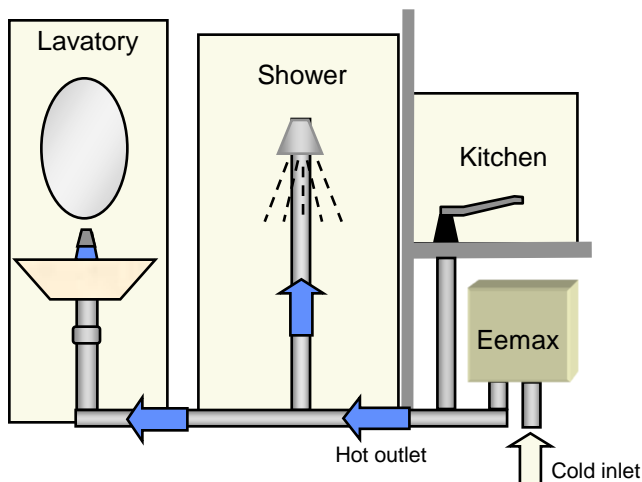

MODELS: **EX380T2T2**

Requirements:

Output: 38 kW @ 240 volts
29 KW @ 208 volts

About 0.85-4.0 GPM at showering temperature.
Best used when operating one or two outlets at a time.



MINIMUM - 8" CLEARANCE ABOVE UNIT

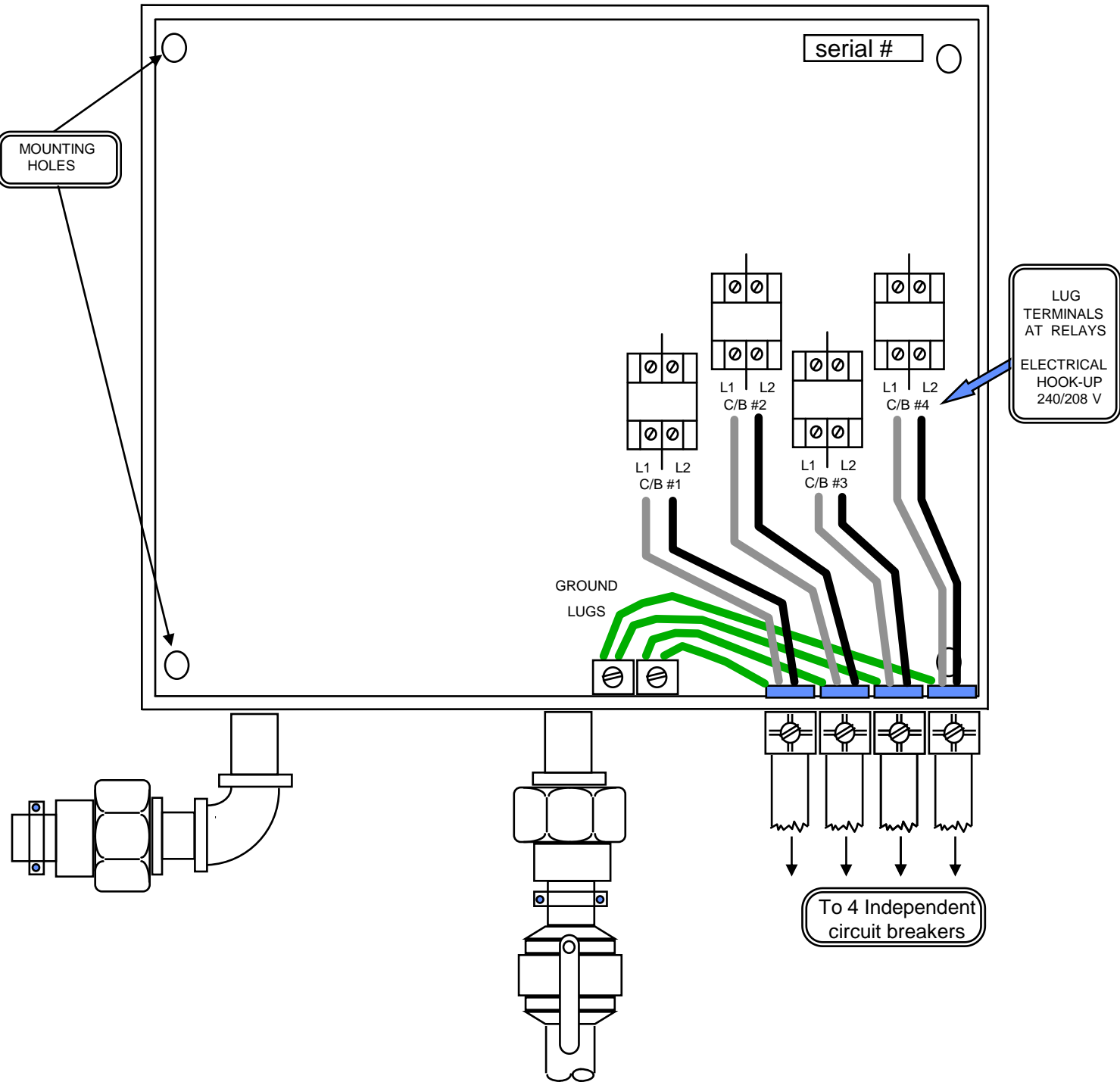
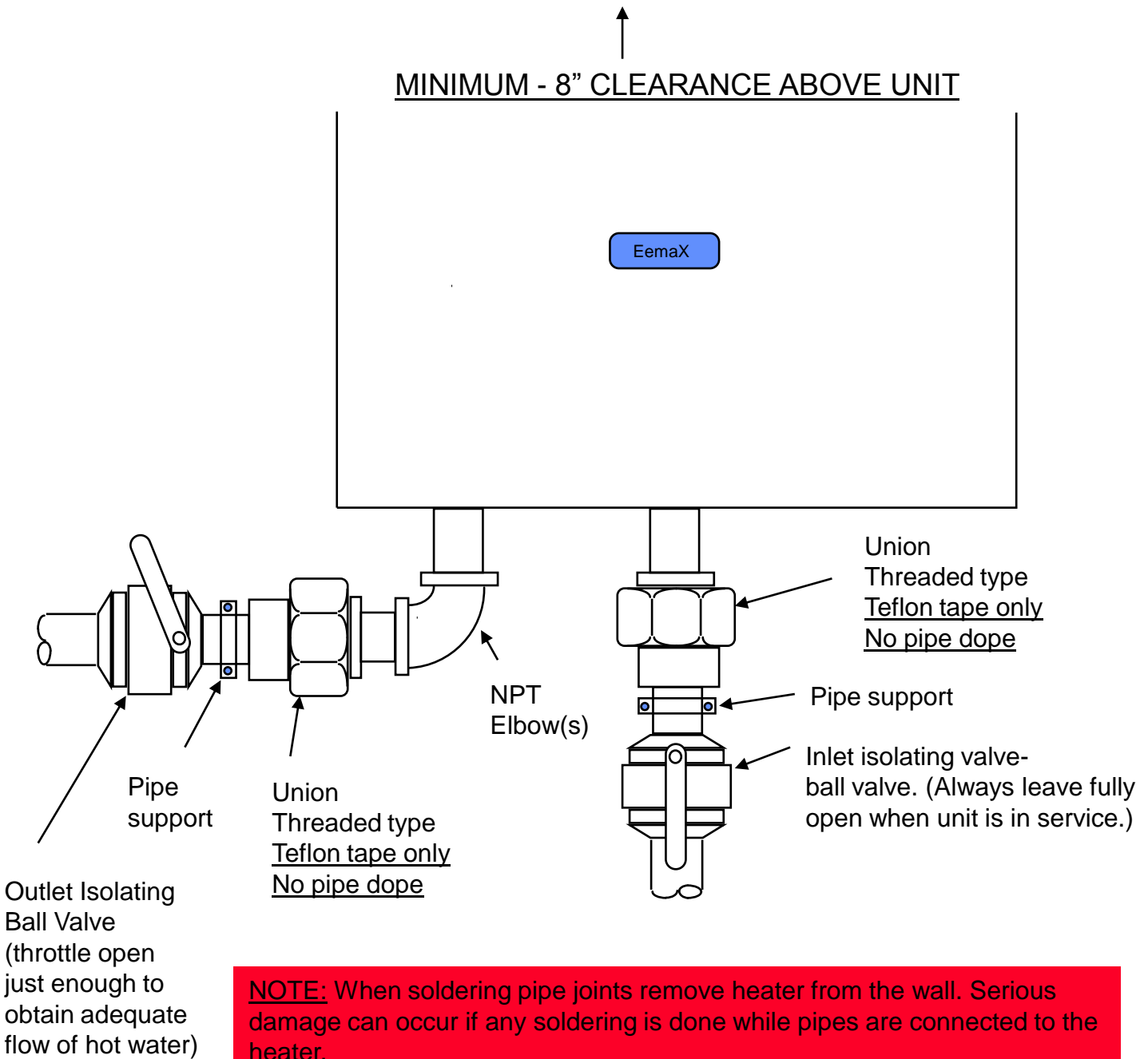

Figure 1A



NOTE: When soldering pipe joints remove heater from the wall. Serious damage can occur if any soldering is done while pipes are connected to the heater.
 Take care to ensure that the pipes are correctly aligned with the inlet and outlet bosses in order to avoid excessive stress on the heater body molding.

Figure 1B

II. PLUMBING HOOK-UP

- 1) The unit is supplied with $\frac{3}{4}$ " NPT fittings (Figure 3), USE THESE. DO NOT USE PIPE DOPE AND DO NOT SOLDER TO THE INLET OR OUTLET.
- 2) Take care to ensure that the pipes are correctly aligned with the inlet and outlet bosses in order to avoid excessive stress on the heater body molding.
NOTE: When soldering pipe joints remove heater from the wall. Serious damage can occur if any soldering is done while pipes are connected to the heater.
When tighten the fittings make sure to secure the fitting inside the heater to make a tight connection.
Run water through the supply pipe to remove all debris from the pipe before connecting the heater. Failure to do so could cause damage to the flow switch.
- 3) Install isolating valves (full flow ball valve type) on both inlet and outlet pipes. This allows unit to be isolated for maintenance purposes. (Fig. 1B)
- 4) When all plumbing is complete, fully check the system for water leaks at all the plumbing connections. If a leak is present take corrective action. Fully open both inlet and outlet BALL VALVES.
Run all the hot water outlets fed by this heater one at a time, for a minute or two, until the water flow is continuous, free from "gulping" and from all visible air pockets.

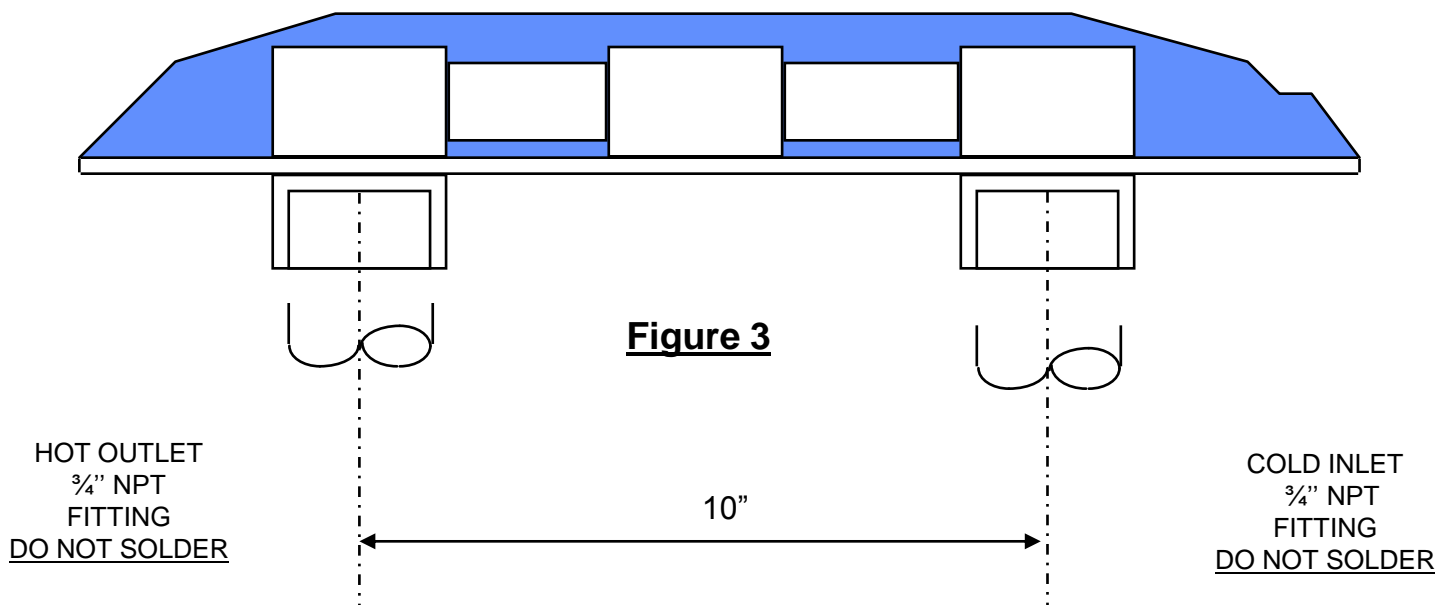

NOTE:
ALL MOUNTING AND PLUMBING MUST BE COMPLETE BEFORE YOU
PROCEED WITH ELECTRICAL HOOK-UP.

TEST THE INSTALLATION FOR LEAKS BEFORE CONNECTING THE
ELECTRICAL SUPPLY.

III. ELECTRICAL HOOK-UP

WARNING
BEFORE BEGINNING ANY WORK ON THE ELECTRICAL INSTALLATION, BE SURE THE SWITCH AT MAIN BREAKER PANEL IS "OFF" TO AVOID ANY DANGER OF ELECTRICAL SHOCK.

"Four Module, Single Phase" heaters are manufactured to the following specifications:

Figure 4

MODEL TYPE	OUTPUT / kW	VOLTAGE / V	AMPERAGE
EX380T2T2	38	* 240	4 x 39 AMPS
EX380T4	38	* 240	4 x 39 AMPS
SPECIAL			

* Units rated of 240 V can operate at 220 V or 208V with reduced output.
 The output will vary in accordance with the following ratios:

volts	208 volts	220 volts	240 volts
output ratio	.75	.84	1.0

This unit must have its own independent circuits, using 4 SETS of UL listed 2 conductor and ground core copper wire cable of the appropriate size protected by 4 separate and independent correctly rated Double Pole Breakers. (208, 220, 240 V, see Figures 4 and 5). Wire entry into the unit must be made through the 4 holes provided in the flange on the backplate.

The "live" wires should be connected to the slots in the terminal block marked L1 and L2. The ground lead must be connected to the slot marked GND. GROUND MUST BE BROUGHT TO THE "GROUND" AT THE CIRCUIT BREAKER PANEL.

Figure 5

4 Separate and independent correctly rated Double pole breakers (240/208 Volts)

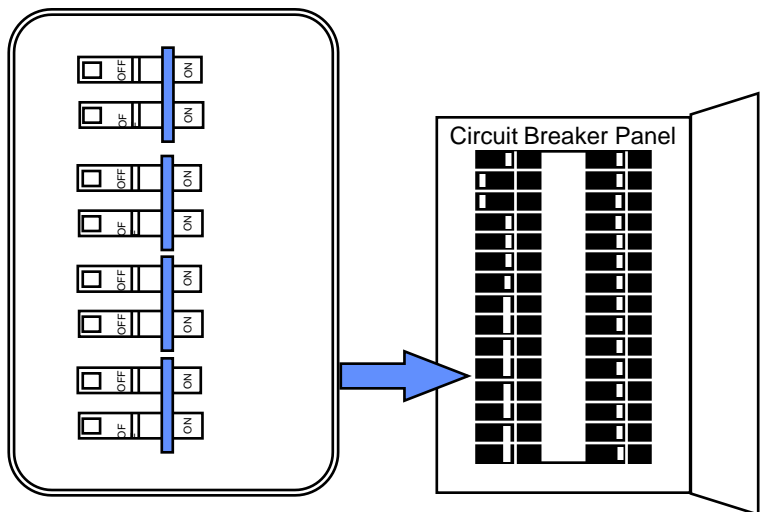

DANGER
FAILURE TO GROUND THE SYSTEM MAY RESULT IN DEATH OR SERIOUS INJURY.

IV COMMISSIONING YOUR HEATER

IMPORTANT

BEFORE SWITCHING “ON” THE POWER AT THE MAIN CIRCUIT BREAKER PANEL MAKE SURE THAT THE HOT WATER CIRCUIT IS FREE OF AIR POCKETS OR ELSE PREMATURE FAILURE OF THE ELEMENT WILL OCCUR. TO DO THIS OPEN ALL HOT WATER OUTLETS ONE AT A TIME FOR A MINUTE OR TWO UNTIL THE WATER FLOW IS CONTINUOUS AND FREE FROM “GULPING” AND FREE FROM VISIBLE AIR POCKETS.

- 1) Open fully both inlet and outlet valves at the heater.
- 2) Open any hot water outlet in the system. If the outlet is a “single lever” mixer type turn to the hottest position. Run for one minute to clear all the air from the system.
- 3) Slowly close OUTLET ball valve until the water flow from the faucet just starts to reduce.
NOTE: This process has two effects. One, any air in the system will be purged out. Two, the heater units will be pressurized at the supply pressure. This will prevent the elements free from air pockets while energized. (Note: **Keep water flowing** while carrying out the procedures outlined below. Flowrate should be at 2-3 gallons per minute to ensure all 4 modules to activate)

GO TO APPROPRIATE SECTION FOR YOUR MODEL

NOTE: For the following sections the first unit is the right hand heating module and the second unit is the right center, far left hand is the forth heating module.

“T2T2” MODELS

- a) Switch on the power to the first unit. The power indicator light should illuminate.
- b) Switch on the power to the second unit, again the power indicator lights should illuminate.
Note: These lights should pulse On and Off at first and after about 20- 30 seconds it should stay fully on.
- c) Switch on the power to the third unit, again the power indicator lights should illuminate.
Note: This light should pulse On and Off at first and after about 20- 30 seconds. It may not stay fully on.
- d) Switch on the power to the forth unit, again the power indicator lights should illuminate.
Note: This light should pulse On and Off at first and after about 20- 30 seconds. It may not stay fully on.
- e) Use the OUTLET ball valve to gradually reduce the water flow until the power indicator light on the third unit begins to pulsate. The water temperature should now be approximately 140 F.
- f) The thermostat is now set and the water temperature will always be the same when the indicator light is pulsing.
- g) Increasing water flow (above the flow rate at which the thermostatic control is no longer effective) will reduce the water temperature.

For “T2T2” Models

If a lower temperature is required, turn the temperature adjustment screw(s) counter-clockwise about 1/8 of a turn (See Figure). Wait 15-20 seconds and check the temperature at the fixture. Repeat this process until the desired temperature has been achieved. (For T2T2 models try to adjust both temperature adjustment screws by about the same amount so that the lights pulse at the same rate.) If you have reduced the temperature considerably from the 140 F setting, you could now open up the outlet ball valve slightly to achieve a higher rate of flow.

When the indicator light is on continuously, the unit is emitting full power. When it is pulsing, the unit is modulating the power to achieve the temperature set by means of the temperature adjustment screw.

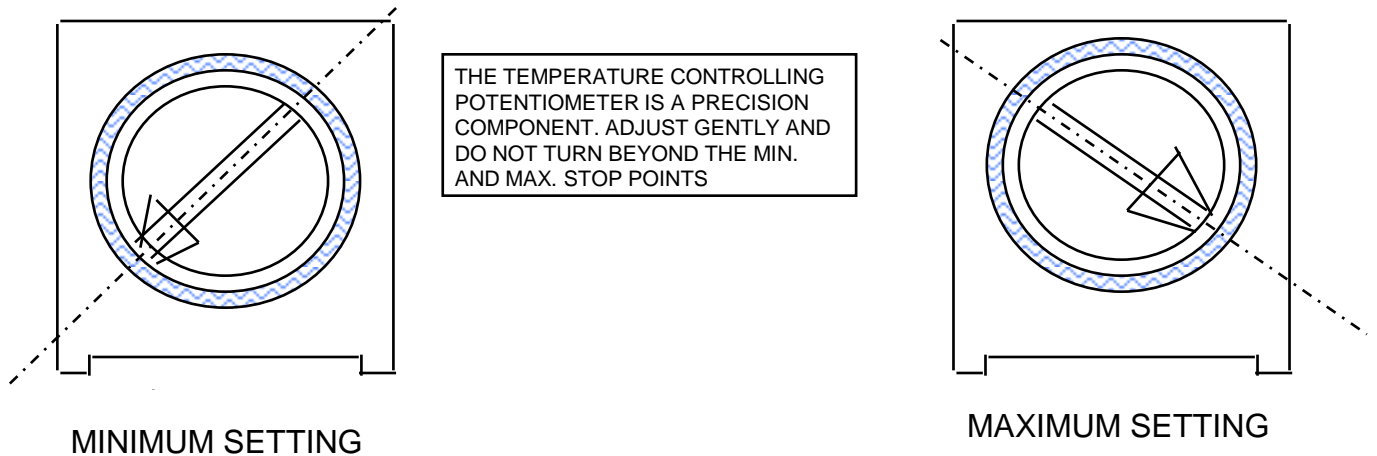

ALL HEATERS

In order to obtain good control at “single lever” mixer type faucets (single spout) the cold water supply to the faucet should be restricted to give approximately the same flow rate of cold water to the faucet as the hot water coming from your Eemax heater. The simplest method of doing this is by partially closing the cold water valve under the sink, as long as this does not shut off pressure to your Eemax heater.

MAXIMUM TEMPERATURE RISE CHART (°F)

OUTPUT	FLOW RATE (GAL. PER MIN.)						
	1	1.5	2	2.5	3	3.5	4
19 KW	130	86	----	----	----	----	----
38 KW	----	----	130	104	86	74	65

TROUBLESHOOTING

SYMPTOM “A”: NO HEAT INDICATOR LIGHT OFF

1) ELECTRIC SUPPLY IS OFF

Turn on the FOUR main circuit breakers.

2) NO OR LOW WATER FLOW

Ensure that the minimum flow rate to switch on your heater is met. “T2T2” Models minimum flow rate = 0.85 gallons per minute. Also check that the inlet filter screen is clear from any debris. This is located in the brass inlet boss.

3) WATER CONNECTIONS ARE REVERSED

Cold water inlet = right side, hot water outlet = left side.

4) ELEMENT BURNED OUT

TURN OFF THE FOUR MAIN CIRCUIT BREAKERS!

Using an ohmmeter test the resistance of the heating element across the two threaded termination rods on top of the element. The resistance reading should be under 10 ohms. If the resistance is much greater than this value, call Eemax for a replacement element.

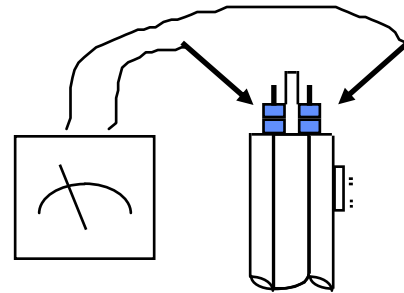

5) ECO TRIPPED (High Limit Thermostat)

TURN OFF THE FOUR MAIN CIRCUIT BREAKERS!

Reset by pushing in red button on each heater module.

SYMPTOM “B”: NO HEAT OR LOW TEMPERATURE WITH INDICATOR LIGHT ON

1) WATER FLOW TOO HIGH

Reduce the water flow by using an outlet ball valve. See page 9 for temperature rise at various flow rates.

2) INCORRECT POWER SUPPLY

Make sure that the unit is connected to the voltage supply specified on the rating label on the the front cover of the unit and no other.

3) ELEMENT BURNED OUT

TURN OFF THE FOUR MAIN CIRCUIT BREAKERS!

Repeat the steps from paragraph 4 above.

4) THERMOSTAT ADJUSTMENT SCREW NOT TURNED UP (Models “T2T2” only.)

Turn both thermostat adjustment screws clockwise in small increments until the indicator light(s) remains on. Take care not to force the screw past it’s stop position. See page 9 for example.

5) ECO TRIPPED (High Limit Thermostat)

TURN OFF THE FOUR MAIN CIRCUIT BREAKERS!

Reset by pushing in red button on each heater module.

EEMAX REPLACEMENT PARTS DIAGRAM

