

# CHAMPION•ESSICK

## Evaporative Cooler Manual

### Models

3000 DD	N31D
3000 SD	N30S
4001 DD	N43/48D
4001 SD	N40/45S
5000 DD	N56/66D
5000 SD	N55/65S

**Circle the model of your cooler and record the serial number below.**

*Encierre con un círculo el modelo de su enfriador y escribe el número de serie abajo.*

**Serial #**

*Número De Serie* \_\_\_\_\_

**Read carefully all of this manual before installing the unit.**

*Lea con cuidado todo este manual antes de instalar la unidad.*

---

### Read And Save These Instructions

*Vea el Español en el interior*

#### Safety Rules

1. Read instructions carefully.
2. Electrical hook up should be done by a qualified electrician, so that all electrical wiring will conform to your local standards.
3. Always turn **OFF POWER** and **UNPLUG** motor and pump inside the cooler before installing or performing any maintenance.
4. Your cooler will run on either 120V or 240V A.C., single phase, 60 Hz (cycle) current.
5. Motor and pump have a grounded, molded plug and an automatic thermal overload switch which will shut motor off when it overheats. The motor will restart automatically when it cools down.
6. Pump receptacle is for grounded evaporative cooler pump only. Do not plug anything else into receptacle.

**⚠WARNING:** To reduce the risk of fire or electric shock, do not use this fan with any "solid-state fan speed control device."

#### Evaporative Cooling

Evaporative cooling is nature's way of cooling. When air is moved over a wet surface, water is evaporated and heat is absorbed. When stepping out of a swimming pool with the wind blowing, evaporative cooling makes you feel cool, even though the air may be warm. The human body itself is cooled primarily by the evaporation of perspiration.

This unit works on the same principle. Air is drawn across wet filter pads where the air is cooled by evaporation and then circulated throughout the building. It is this combination of cooled air and the movement of air over the skin which makes it feel cool.

Unlike refrigeration systems which recirculate the air, an evaporative cooler continually brings in fresh air while exhausting old air. You are completely replacing the air every 2 to 4 minutes by opening windows or doors or a combination of both. The air is always fresh, not stale, laden with smoke and odors as happens with refrigerated air conditioning.

#### Operation

For the best cooling performance, if the pads are dry, pre-wet the pads by running the pump for a few minutes before starting the blower.

These coolers may be used without water for ventilation purposes. When outside air is cool (for example, at night) or when humidity is high, the water pump can be turned off.

A cooler can also be installed with a thermostat and attic exhaust dampers to provide completely automatic operation.

#### Open Windows To Exhaust Air

An often misunderstood concept of evaporative cooling is the amount of air that should be exhausted. How much should you open your windows? The fact is that most people do not open their windows enough. The following two methods will help you determine the amount to open your windows.

#### CFM Method

You should allow an opening of at least 2 square feet (288 square inches) for each 1000 CFM rating of your unit. **Example:** At 3654 CFM, model 4001 DD with a 1/2 hp motor requires 7.3 square feet (1052 square inches) of opening ( $3654/1000 * 2 = 7.3$ ). Multiply the number of windows by window width in inches and divide this into the number of square inches required for your size unit. This will give you the height to open windows. In this example, four 36 inch wide windows should be opened 7.3 inches each.

## Champion Air Balancing Method

1. Take a piece of tissue paper and cut it lengthwise into 3 equal strips.
2. Turn your cooler on high cool.
3. Open one window at least six inches wide in each room that you want to cool.
4. Take the piece of tissue paper and put it up against the screen of the open window furthest from the cooler discharge opening. Let go of it. It will do one of three things.

**IF** It falls down.  
**THEN** CLOSE all of the windows one inch and try step 4 again.

**IF** It plasters itself to the screen.  
**THEN** OPEN all of the windows one inch and try step 4 again.

**IF** It stays on the screen lightly.  
**THEN** PERFECT. You are done. Enjoy your cooler.

### NOTES:

- When switching to low cool, you must rebalance your home. Repeat step 4.
- Once you balance your home you can cool some areas more than others by opening those windows more and closing the others by the same amount. Repeat step 4 to make sure your home is still air balanced.

## Installation

**NOTE:** The pump comes installed. The belt, motor pulley, and motor cord and float are included in the cabinet, the motor is shipped separately.

**⚠CAUTION:** Make sure that the mounting surface is strong enough to support the operating weight of the cooler when in use. (For operating weight, see Specification Table.)

**⚠CAUTION:** Never plug in cooler until installation is complete and unit has been tested for rigidity.

- **Install Duct Adapters.** If desired, a 4 piece duct adapter is available as an optional accessory. Call 1-800-643-8341 to obtain these from the factory. Align the holes in the duct adapter to the holes in the blower opening and attach using the provided screws (see Fig. 1). Repeat for all four sides. Note: All 4 pieces are identical except for models 5000SD & N55/65S which have an offset piece which attaches to the bottom of the outlet. To install this offset piece, remove the screws holding the cut-off plate and slide the offset duct adapter between the blower opening and the cut-off plate. You may need to loosen other screws to do this. Line up the holes and secure with the screws previously removed.

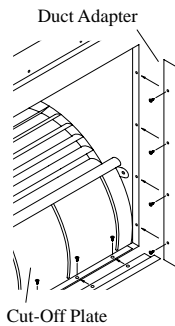

Fig. 1

## Motor Installation

- **Install motor cord.** For typical 120V operation, connect motor cord to motor using the following color code: Black - Hi, Red - Low, White - Com., Green - Ground. (See Wiring Diagrams)

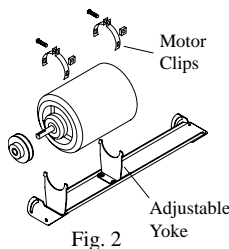

Fig. 2

- **Mount motor.** Install blower motor in the motor mount yokes, adjusting the yoke if necessary. Fasten with the provided mounting clips (see Fig. 2).

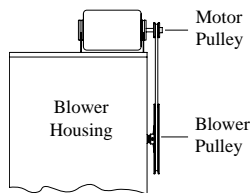

Fig. 3

- **Install pulley.** Install the adjustable motor pulley so that it aligns with the blower drive pulley (see Fig. 3) and tighten set screw.

## Electrical Installation

**⚠WARNING:** Disconnect all electrical service that will be used for this unit before you begin the installation.

- **Remove junction box.** The electrical junction box is located in the upper inside corner of the cooler cabinet. Remove the two screws and remove the junction box (Fig. 4). Slide receptacles into slots in junction box.

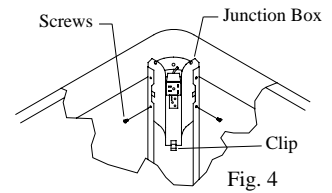

Fig. 4

- **Hook up electrical.** Electrical hook up should be done by a qualified electrician, so that all electrical wiring will conform to your local standards. This unit is supplied with a 120V pump. For 240V pump operation, a 240V pump must be purchased. The fan and pump receptacles will support both 120V and 240V installations. See the wiring diagrams for 120V and 240V installations. **Note:** Clip pump cord onto cord clip located on the bottom of the junction box to keep cord out of the water.

**IMPORTANT:** When a single speed motor is used, do not use the red lead on the receptacle and motor plug wiring. Tape off end of both of the red leads.

**⚠CAUTION:** Pump receptacle is for grounded evaporative cooler pump only. Do not plug anything else into receptacle.

**⚠WARNING:** Make sure the cooler cabinet is properly grounded to a suitable ground connection for maximum safety.

## Wiring Diagrams

### 120 Volts

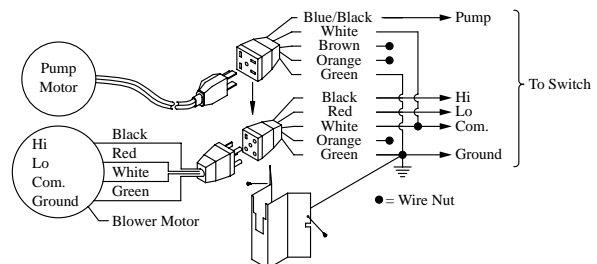

### 240 Volts

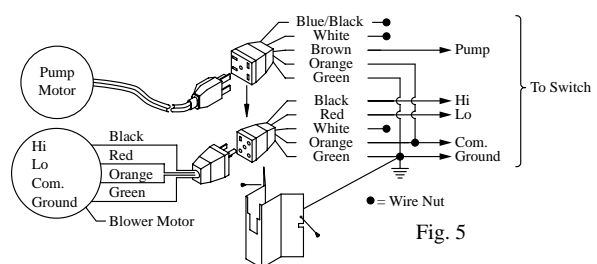

Fig. 5

## Water Connection

- **Install overflow assembly.** Place drain nipple through the hole in the pan, with the rubber washer between the pan and the head of the drain nipple (Fig. 6). Screw on nut and draw up tight against bottom of pan. Insert the overflow pipe in the nipple to retain water. The overflow pipe may be removed to drain the pan when necessary. A garden hose may be screwed on the drain nipple to drain water away from your unit.

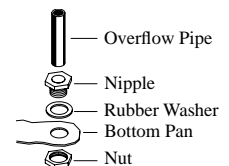

Fig. 6

- **Connect water supply line.** Find the closest supply of water. Use a saddle valve (Fig. 7) to connect 1/4" tubing to the cold water supply or use a Sillcock and water valve connected to an outside faucet (Fig. 8). Place the nut and ferrule on the tubing and tighten the nut until water tight. **IMPORTANT:** Do not connect the water supply to any soft water applications. Soft water will cause corrosion and decrease the life of the cooler.

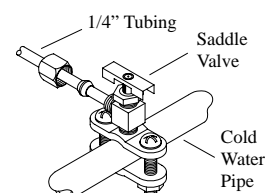

Fig. 7

- **Install float and attach water line to float.** The float may be installed in either the corner post or bracket (see Fig. 9). If you have model 3000DD/N31D then the float should be mounted to the bracket. Refer to figure 10 for installation instructions. Insert the float (1) thru the hole in the corner post or bracket. Install the washer (2) and nut (3). Tighten to keep the float from turning. Place the nut (5) and ferrule (4) on the water supply line. Connect to float fitting and tighten until water tight.

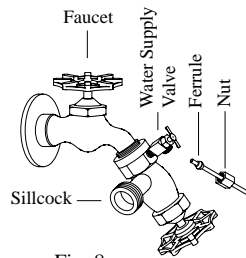

Fig. 8

- **Fill pan.** Allow water to fill to within 1" of top of pan and adjust float to maintain this water level. This can be accomplished by bending the float rod.

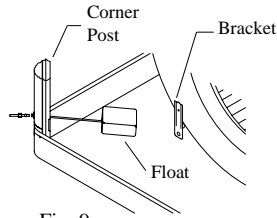

Fig. 9

- **Level water troughs.** Operate pump until pads are saturated. Check each trough to see if water is evenly dispersed in the trough. If they are not, loosen adjustment bolts and level trough. Retighten bolts. Check to see that all pads are saturated with water and that there are no dry spots or openings in the pads.

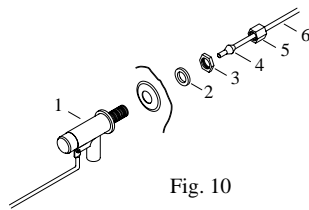

Fig. 10

## Bleed-Off

Installation of the bleed-off kit is recommended to increase the life of the cooler. A bleed-off system is designed to prevent scale build up by continually removing a small percent of the water in the pan.

- **Install Bleeder Tee and Tubing.** Refer to figure 11. Cut the pump hose and insert the barbed ends of the bleeder tee into each cut end. Insert one end of the bleeder tubing onto the bleeder tee and run the other end out of the cooler through the overflow pipe. **Note:** A restrictor clamp is provided which, if desired, may be installed onto the bleeder tubing to restrict the amount of water being bleed off. The amount of water to bleed off depends on the quality of the water in your area. Start with 1-2 gal/hr and increase if needed.

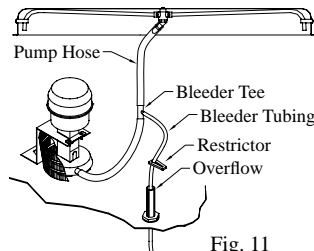

Fig. 11

## Amperage Draw And Belt Tension

This unit is equipped with an adjustable motor drive pulley for adjusting the blower wheel speed to the proper loading on different duct systems. It is important that the motor drive pulley is adjusted to correct size to assure maximum air delivery without damage to the motor. Be sure to follow these instructions carefully.

- **Adjust drive pulley.** After the unit is completely installed, adjust the drive pulley to the least diameter and adjust belt tension. See the maintenance section for adjusting belt tension.
- **Start cooler.** Install all pad frames, start pump, and allow to operate until pads are wet.
- **Check amperage.** With pads wet and unit started, check amperage draw with an amperage meter.

- **Adjust pulley if necessary.** If amperage draw is less than motor rating, turn off electrical power and remove pad frame. Unplug motor inside cooler, this will protect you from someone turning on unit while you are working inside. This should be done for your

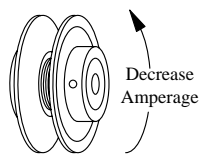

Fig. 12

safety. Adjust pulley to a larger diameter and readjust belt tension, plug motor in, install pad frame, and retest amperage draw. Repeat this process until correct amperage draw is attained. Increasing motor pulley diameter increases amperage draw. Decreasing motor pulley diameter decreases amperage draw (see Fig. 12).

**CAUTION:** Do not operate cooler with larger amperage draw than specified on motor plate.

**NOTE:** No attempt should be made to completely install this unit without the aid of an electrician or someone familiar with testing amperage draw. Failure to comply with these instructions may void your warranty.

## Maintenance

**WARNING:** Before doing any maintenance be sure power is off. At the time you remove a pad frame be sure to unplug motor and pump. This is for your safety.

### Spring Start-Up

- **Clean pump.** Cleaning the pump is necessary once a year at start-up. For your safety, turn unit off and unplug motor and pump. Remove the pump from the mount slot. Remove the base of the pump (Fig. 13). Clean the pump and turn the impeller to ensure free operation. Remove the pump spout and check for any blockage. After cleaning, reinstall the base onto the pump. Press firmly to make sure it is secure. Reattach the pump to the mount in the cooler using the plastic retainer to ensure that the pump will not overturn. Do not forget to replace the spout and water delivery tube onto the pump outlet.

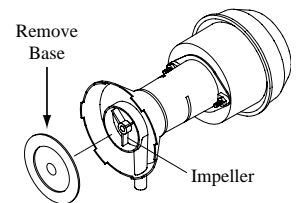

Fig. 13

- **Oil bearings.** The blower bearings and cooler motor in this unit should be oiled with a few drops of non-detergent 20/30 weight oil once each year. The motor does not need oil if it has no oil lines for oiling. Motors that have no lines are lifetime oiled at the factory and require no further oiling for the life of the unit.

**CAUTION:** Do not over oil. Over oiling can cause motor burn out, due to excessive oil getting into motor winding.

- **Change Pads.** The pads should be replaced once or twice a season, depending upon the length of the season. At the beginning and at mid season a clean pad is more absorbent and efficient and will deliver substantially more cool air.

- **Check belt tension.** A 3 lb. force should deflect the belt 3/4 inches (see Fig. 14). Readjust belt if needed.

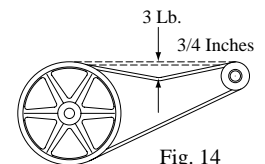

Fig. 14

- **Check bleed-off valve to be sure it is not clogged.**

## WINTER SHUT DOWN

- **Drain water.** Always drain all of the water out of the cooler and water supply line when not in use for prolonged periods, and particularly at the end of the season. Keep the water line disconnected from both the unit and water supply so that it does not freeze.

- **Unplug motor and pump.** When cooler is not used for extended periods, unplug the motor and pump from inside cooler.

- **Cover unit.** To protect the life of the finish, a cover for the unit is suggested in extended periods of non use.

By following the operating, installation, and maintenance suggestions as outlined, you can get many years of efficient and satisfactory service from your cooler. In the event additional information is desired, your dealer will be more than glad to assist you in every possible way.

# Troubleshooting

<u>Problem</u>	<u>Possible Cause</u>	<u>Remedy</u>
Failure to start or no air delivery	<ol style="list-style-type: none"> <li>No electrical power to unit                             <ul style="list-style-type: none"> <li>Fuse blown</li> <li>Circuit breaker tripped</li> <li>Electric cord unplugged or damaged</li> </ul> </li> <li>Belt too loose or tight</li> <li>Motor overheated                             <ul style="list-style-type: none"> <li>Belt too tight</li> <li>Blower bearings dry</li> <li>Motor pulley diameter too large</li> </ul> </li> <li>Motor locked</li> </ol>	<ol style="list-style-type: none"> <li>Check power                             <ul style="list-style-type: none"> <li>Replace fuse</li> <li>Reset breaker</li> <li>Plug in cords or replace if damaged</li> </ul> </li> <li>Adjust belt tension</li> <li>Determine cause of overheating                             <ul style="list-style-type: none"> <li>Adjust belt tension</li> <li>Oil blower bearings</li> <li>Adjust pulley to correct diameter</li> </ul> </li> <li>Replace motor</li> </ol>
Inadequate air delivery with cooler running	<ol style="list-style-type: none"> <li>Insufficient air exhaust</li> <li>Belt too loose</li> <li>Pads plugged</li> <li>Motor underloaded</li> </ol>	<ol style="list-style-type: none"> <li>Open windows or doors to increase air flow</li> <li>Adjust belt tension or replace if needed</li> <li>Replace pads</li> <li>Adjust pulley to full load ampere rating of motor</li> </ol>
Inadequate cooling	<ol style="list-style-type: none"> <li>Inadequate exhaust in house                             <ul style="list-style-type: none"> <li>Pads plugged</li> <li>Open spots in pads</li> <li>Trough holes clogged</li> </ul> </li> <li>Pads not wet                             <ul style="list-style-type: none"> <li>Pump not working properly</li> </ul> </li> </ol>	<ol style="list-style-type: none"> <li>Open windows or doors to increase air flow</li> <li>Check water distribution system                             <ul style="list-style-type: none"> <li>Replace pads</li> <li>Repack pads</li> <li>Clean trough and unplug holes</li> <li>Replace or clean pump (Unplug unit)</li> </ul> </li> </ol>

<u>Problem</u>	<u>Possible Cause</u>	<u>Remedy</u>
Motor cycles on and off	<ol style="list-style-type: none"> <li>Low voltage</li> <li>Excessive belt tension</li> <li>Blower shaft tight or locked</li> <li>Bearings dry</li> <li>Motor pulley diameter too large causing motor overload</li> </ol>	<ol style="list-style-type: none"> <li>Check voltage</li> <li>Adjust belt tension</li> <li>Oil or replace bearings (Unplug unit)</li> <li>Oil bearings</li> <li>Adjust pulley so full load ampere rating of motor is not exceeded</li> </ol>
Noisy	<ol style="list-style-type: none"> <li>Bearings dry</li> <li>Wheel rubbing blower housing</li> <li>Loose parts</li> </ol>	<ol style="list-style-type: none"> <li>Oil bearings</li> <li>Inspect and realign (Unplug unit)</li> <li>Tighten loose parts</li> </ol>
Musty or unpleasant odor	<ol style="list-style-type: none"> <li>Stale or stagnate water in cooler</li> <li>Pads mildewed or clogged</li> <li>Pads not wetting properly                             <ul style="list-style-type: none"> <li>Trough holes clogged</li> <li>Pump not working properly</li> </ul> </li> </ol>	<ol style="list-style-type: none"> <li>Drain pan and clean pads</li> <li>Replace pads</li> <li>Check water distribution system                             <ul style="list-style-type: none"> <li>Clean</li> <li>Replace or clean pump (Unplug unit)</li> </ul> </li> </ol>
Water draining onto roof	<ol style="list-style-type: none"> <li>Float arm not adjusted properly</li> <li>Overflow assembly leaking</li> </ol>	<ol style="list-style-type: none"> <li>Adjust float</li> <li>Tighten nut and overflow pipe.</li> </ol>
Excessive humidity in house	<ol style="list-style-type: none"> <li>Inadequate exhaust in house</li> </ol>	<ol style="list-style-type: none"> <li>Open doors or windows</li> </ol>

Register your product online at [www.championcooler.com/eac/online-registration-eac.htm](http://www.championcooler.com/eac/online-registration-eac.htm)

## Limited Warranty

This warranty is extended to the original purchaser of an evaporative cooler installed and used under normal conditions. It does not cover damages incurred through accident, neglect, or abuse by the owner. We do not authorize any person or representative to assume for us any other or different liability in connection with this product.

### Terms And Conditions Of The Warranty

For Eight Years from date of Purchase, we will replace the original base assembly if water leakage should occur due to rust out.

For One Year from date of Purchase, we will replace any original component provided by Champion Cooler which fails due to any defect in material or factory workmanship only.

### Exclusions From The Warranty

We are not responsible for replacement of cooler pads. These are disposable components and should be replaced periodically. We are not responsible for any incidental or consequential damage resulting from any malfunction.

We are not responsible for any damage received from the use of water softeners, chemicals, descale material, plastic wrap, or if a motor of a higher horsepower than what is shown on the serial plate is used in the unit.

We are not responsible for the cost of service calls to diagnose cause of trouble, or labor charge to repair and/or replace parts.

### How To Obtain Service Under This Warranty

Contact the Dealer where you purchased the evaporative cooler. If for any reason you are not satisfied with the response from the dealer, contact the Customer Service Department: 5800 Murray Street, Little Rock, Arkansas 72209. 1-800-643-8341. E-mail: [info@championcooler.com](mailto:info@championcooler.com).

**This limited warranty applies to original purchaser only.**

## Replacement Parts List / Lista De Piezas De Recambio

When ordering parts, please be sure to furnish the following information on all orders. Failure to do so may delay your order. /  
 Al pedir piezas, incluya toda la información siguiente con su pedido. El no proporcionar toda esta información resultará en una demora.

1. Cooler model number / *El modelo de su enfriador*
2. Cooler serial number / *Número de serie de la unidad*
3. Motor HP / *C.V. del motor*
4. Description and part number / *Descripción y número de pieza*
5. Date of purchase / *Fecha de compra*

No. <u>N°</u>	<u>Description / Descripción</u>	<b>3000 DD</b> <b>N31D</b>	<b>4001 DD</b> <b>N43/48D</b>	<b>5000 DD</b> <b>N56/66D</b>
1.	Top Pan / <i>Tapa</i> -----	222903-003	220901-002	220903-002
2.	Bottom Pan / <i>Base De La Caja</i> -----	322907-002	320905-007	320906-005
3.	Louvered Side / <i>Reja Lateral</i> -----	224006-003	224007-005	224008-003
4.	Water Trough / <i>Canal De Agua</i> -----	226003-001	226003-002	226003-003
5.	Aspen Pads / <i>Filtros De Paja</i> -----	110091	110098	110092
6.	Pad Retainers / <i>Soporte Para El Filtro</i> -----	3PW-4	3PW-5	3PW-6
7.	Corner Post, With Float Hole / <i>Poste De Esquina, Con Agujero Para Flotador</i> -----	224003-008	224003-034	224003-025
8.	Corner Post, No Float Hole / <i>Poste De Esquina, Sin Agujero Para Flotador</i> -----	224003-026	224003-035	224003-010
8a.	Corner Post, For Pump Mount / <i>Poste De Esquina, Para Montar La Bomba</i> -----	224003-038	224003-039	224003-040
9.	Cut-Off Plate / <i>Placa Limitadora</i> -----	224002-001	224004-002	224004-003
10.	Blower Housing / <i>Caja De La Rueda</i> -----	324106-202	324107-007	324111-001
11.	Blower Wheel / <i>Rueda</i> -----	12BW	16BW	20BW
12.	Shaft, Blower Wheel / <i>Eje De La Rueda</i> -----	110182	110183	110183
13.	Bearings, Blower Wheel Shaft / <i>Cojinetes Del Eje De La Rueda</i> -----	110351	110351	110351
14.	Pulley, Blower Wheel / <i>Polea De La Rueda</i> -----	110274	110275	110276
15.	Drive Belt / <i>Correa</i> -----	110211	110215	110214
16.	Motor / <i>Motor</i> -----	*	*	*
17.	Pulley, Motor / <i>Polea Del Motor</i> -----	110277	110278	110278
18.	Motor Mount / <i>Montura Del Motor</i> -----	314003-002	314003-004	314003-008
19.	Motor Mount Clips / <i>Seguros Para Montar Motor</i> -----	314005-001	314005-001	314005-001
20.	Electrical Cord, Motor (115V) / <i>Cable Eléctrico Del Motor (115V)</i> -----	110364	110364	110364
20.	†Electrical Cord, Motor (230V) / <i>Cable Eléctrico Del Motor (230V)</i> -----	†110372-2	†110372-2	†110372-2
21.	Float Valve / <i>Flotador</i> -----	FL-C	FL-C	FL-C
22.	Pump Mount / <i>Montura De La Bomba</i> -----	218001-030	218001-031	218001-031
23.	Pump Screen / <i>Malla Para La Bomba</i> -----	281001-001	281001-001	281001-001
24.	Pump Assembly / <i>Bomba</i> -----	110436	110436	110436
25.	Pump Retainer / <i>Sujetador De La Bomba</i> -----	110714	110714	110714
26.	Air Baffle / <i>Baflé De Aire</i> -----	224112-001	-	224108-003
27.	Float Bracket / <i>Soporte Del Flotador</i> -----	216001-003	216001-003	216001-003
28.	Tube, Water Delivery / <i>Tubo De Agua</i> -----	310716	310716	310716
30.	Over Flow Assembly / <i>Montaje De Desagüe</i> -----	30A-1	30A-1	30A-1
31.	Water Distributor Assembly / <i>Sistema Del Distribuidor De Agua</i> -----	3D-4	3D-5	3D-6
32.	Holder, Water Distributor / <i>Soporte Para El Distribuidor De Agua</i> -----	110574	110574	110574
34.	Electrical Junction Box / <i>Caja De Empalme</i> -----	320106-002	320106-002	320106-002
35.	Receptacle, Motor / <i>Tomacorriente Del Motor</i> -----	110393	110393	110393
36.	Receptacle, Pump / <i>Tomacorriente De La Bomba</i> -----	110361	110361	110361
37.	Bearing Mount, Right / <i>Montura Del Cojinete, Derecha</i> -----	-	-	214114-001
38.	Bearing Mount, Left / <i>Montura Del Cojinete, Izquierda</i> -----	-	-	214114-001
39.	Motor Mount Support, Right / <i>Soporte Para El Montura Del Motor, Derecho</i> -----	-	-	214114-002
40.	Motor Mount Support, Left / <i>Soporte Para El Montura Del Motor, Izquierdo</i> -----	-	-	214114-002
41.	Channel Retainer Support / <i>Soporte Para El Retenedor De Canal</i> -----	-	-	218114-001
42.	Bleed-Off Kit / <i>Equipo De Purga</i> -----	310586	310586	310586

\* See motor specification table. / *Vea la tabla de especificaciones del motor.*

† 230V motor cord is optional and not supplied with cooler. / *Cable eléctrico del motor de 230V es opcional y no se envía con el enfriador.*

NOTE: Standard hardware items may be purchased from your local hardware store.

NOTA: Artículos de uso corriente pueden comprarse en la ferretería de su localidad.

## Parts Drawing / Dibujo De Piezas

3000DD, 4001DD, 5000DD  
N31D, 43/48D, 56/66D

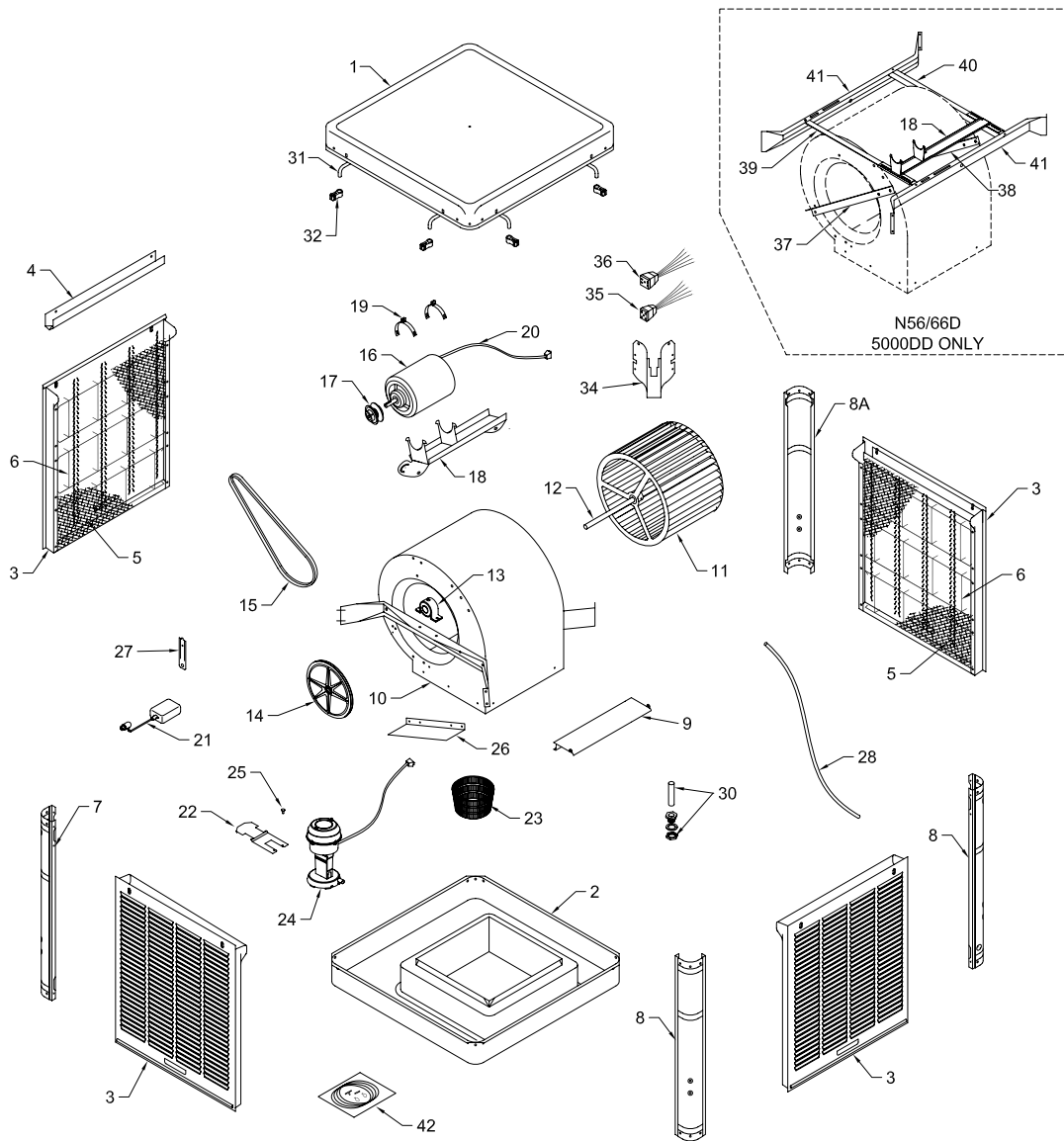

## General Specifications / Especificaciones Generales

Model No. Modelo	HP C.V.	Weight (lbs.) Peso (libras)		Cabinet Dimensions (in.) Dimensiones De La Caja (pulgadas)			Duct Opening (in.) Abertura De Ducto (pulgadas)	
		*Dry Seco	*Operating Lleno	Height Altura	Width Anchura	Depth Profundidad	Width Anchura	Height Altura
3000DD & N31D	1/3	125	175	33 7/16	28 1/8	28 1/8	13 5/8	13 5/8
4001DD & N43/48D	1/3 1/2	165 166	232 233	34 1/2	34 1/8	34 1/8	17 3/4	17 3/4
5000DD & N56/66D	1/2 3/4	222 226	305 309	42 7/16	39	39	19 3/4	19 3/4
3000SD & N30S	1/3	116	193	33 7/16	28 1/8	28 1/8	13 5/8	13 5/8
4001SD & N40/45S	1/3 1/2	154 155	268 269	34 1/2	34 1/8	34 1/8	17 3/4	17 3/4
5000SD & N55/65S	1/2 3/4	204 208	353 357	42 7/16	39	39	19 3/4	19 3/4

\* Includes motor weight / Incluye el peso del motor.

## Parts Drawing / Dibujo De Piezas

3000SD, 4001SD, 5000SD  
N30S, N40/45S, N55/65S

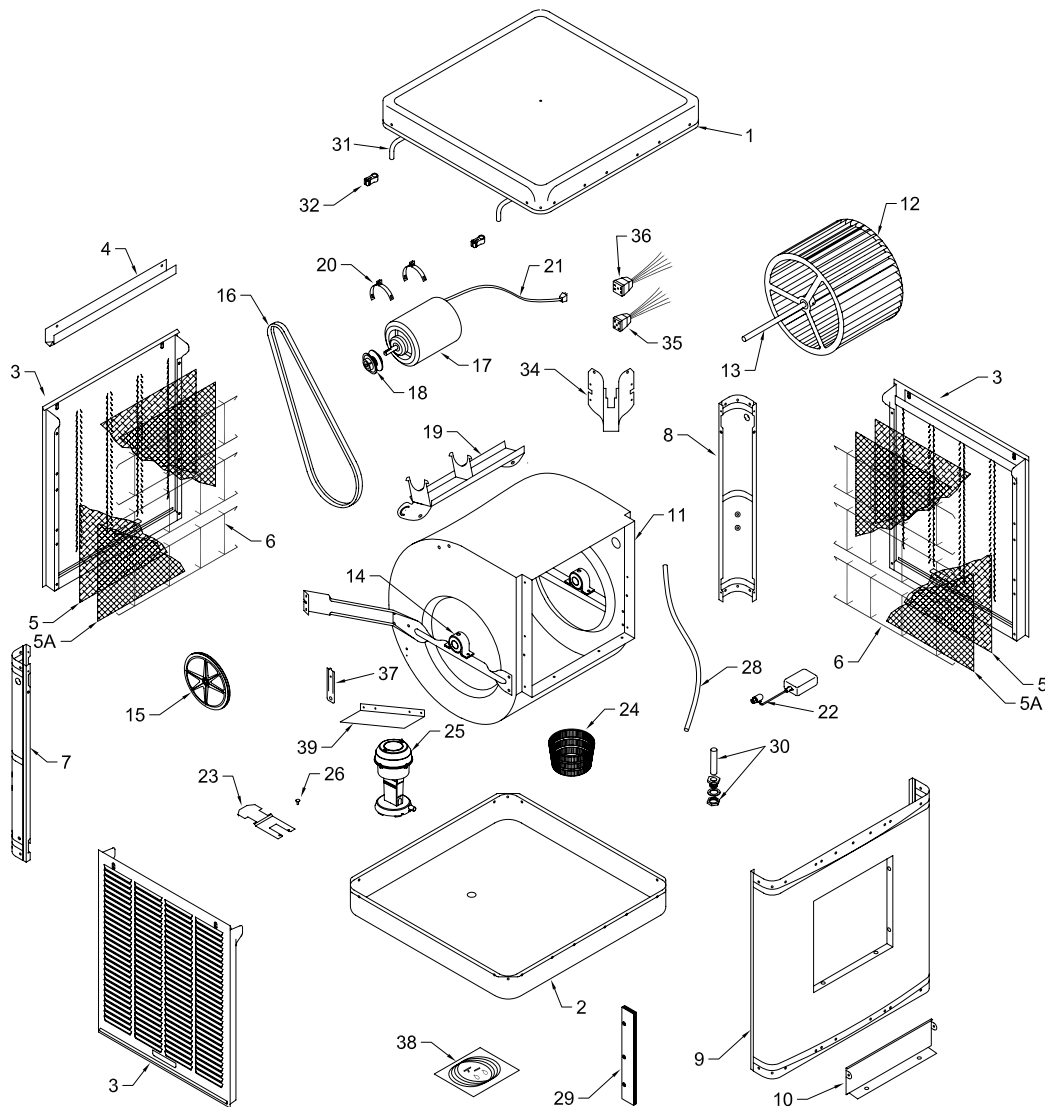

## Motor Specifications / Especificaciones Del Motor

Model No. Modelo	HP C.V.	Motor Part # Motor - N°	Speed Velocidad	Volts Voltios	**Amperage Amperaje	*Motor Pulley Part # Polea Del Motor - N°	Drive Belt Part # Correa - N°
3000DD, N31D, 3000SD & N30S	1/3	110444 110445	1 2	115	7.2	110277	110211 (4L-450)
4001DD, N43/48D, 4001SD & N40/45S	1/3	110444 110445	1 2	115	7.2	110278	110215 (4L-560)
	1/2	110446 110447	1 2	115	9.8		
5000DD, N56/66D, 5000SD & N55/65S	1/2	110446 110447	1 2	115	9.8	110278	(DD, D) 110214 (4L-690) (SD, S) 110213 (4L-670)
	3/4	110448 110449	1 2	115	13.8		

\* 1/2" Bore x Adjustable O.D. / Taladro de 1/2 pulgadas x Diámetro Externo Ajustable.

\*\* Amperage shown is from National Electric Code. Use motor nameplate for more accurate amp reading. / El amperaje listado es del código eléctrico nacional. Utilice el amperaje indicado en la placa del motor para un amperaje más exacto.

## Replacement Parts List / Lista De Piezas De Recambio

When ordering parts, please be sure to furnish the following information on all orders. Failure to do so may delay your order. /  
 Al pedir piezas, incluya toda la información siguiente con su pedido. El no proporcionar toda esta información resultará en una demora.

1. Cooler model number / *El modelo de su enfriador*
2. Cooler serial number / *Número de serie de la unidad*
3. Motor HP / *C.V. del motor*
4. Description and part number / *Descripción y número de pieza*
5. Date of purchase / *Fecha de compra*

No. N°	Description / Descripción	3000 SD N30S	4001 SD N40/45S	5000 SD N55/65S
1.	Top Pan / Tapa .....	222903-002	220901-001	220903-001
2.	Bottom Pan / Base De La Caja.....	222904-003	220902-002	220905-006
3.	Louvered Side / Reja Lateral.....	224006-003	224007-005	224008-003
4.	Water Trough / Canal De Agua .....	226003-001	226003-002	226003-003
5.	Aspen Pads / Filtros De Paja .....	110091	110098	110092
5a.	Glass Fiber Pads / Filtros De Vidrio.....	-	110129-003	-
6.	Pad Retainers / Soporte Para La Esponja .....	3PW-4	3PW-5	3PW-6
7.	Corner Post, With Float Hole / Poste De Esquina, Con Agujero Para Flotador .....	224003-004	224003-034	224003-006
8.	Corner Post, For Pump Mount / Poste De Esquina, Para Montar La Bomba .....	224003-041	224003-039	224003-043
9.	Front Panel / Panel De Frente .....	224106-001	224105-005	222108-004
10.	Cut-Off Plate / Placa Limitadora .....	224002-001	224004-001	224004-001
11.	Blower Housing / Caja De La Rueda.....	324106-102	324107-206	324108-004
12.	Blower Wheel / Rueda.....	12BW	16BW	20BW
13.	Shaft, Blower Wheel / Eje De La Rueda .....	110182	110183	110183
14.	Bearings, Blower Wheel Shaft / Cojinetes Del Eje De La Rueda.....	110351	110351	110351
15.	Pulley, Blower Wheel / Polea De La Rueda.....	110274	110275	110276
16.	Drive Belt / Correa.....	110211	110215	110213
17.	Motor / Motor.....	*	*	*
18.	Pulley, Motor / Polea Del Motor.....	110277	110278	110278
19.	Motor Mount / Montura Del Motor.....	314003-006	314003-004	314003-004
20.	Motor Mount Clips / Seguros Para Montar Motor .....	314005-001	314005-001	314005-001
21.	Electrical Cord, Motor (115V) / Cable Eléctrico Del Motor (115V).....	110364	110364	110364
21.	§Electrical Cord, Motor (230V) / Cable Eléctrico Del Motor (230V) .....	§110372-2	§110372-2	§110372-2
22.	Float Valve / Flotador.....	FL-C	FL-C	FL-C
23.	Pump Mount / Montura De La Bomba.....	218001-031	218001-031	218001-031
24.	Pump Screen / Malla Para La Bomba.....	281001-001	281001-001	281001-001
25.	Pump Assembly / Bomba.....	110436	110436	110436
26.	Pump Retainer / Sujetador De La Bomba .....	110714	110714	110714
28.	Tube, Water Delivery / Tubo De Agua.....	310716	310716	310716
29.	†Duct Adapters / Adaptadores Del Conducto.....	†324016-001	†324016-002	†324016-003
30.	Over Flow Assembly / Montaje De Desagüe .....	30A-1	30A-1	30A-1
31.	Water Distributor Assembly / Sistema Del Distribuidor De Agua .....	3D-2	3D-10	3D-9
32.	Holder, Water Distributor / Soporte Para El Distribuidor De Agua .....	110574	110574	110574
34.	Electrical Junction Box / Caja De Empalme .....	320106-002	320106-002	320106-002
35.	Receptacle, Motor / Tomacorriente Del Motor .....	110393	110393	110393
36.	Receptacle, Pump / Tomacorriente De La Bomba.....	110361	110361	110361
37.	Float Bracket / Soporte Del Flotador.....	216001-003	216001-003	216001-003
38.	Bleed-Off Kit / Equipo De Purga.....	310586	310586	310586
39.	Air Baffle / Bafle De Aire .....	-	222119-002	224108-003

\* See motor specification table. / *Vea la tabla de especificaciones del motor.*

† Optional Accessory. Not included with unit. / *Accesorio opcional. No incluido con la unidad.*

§ 230V motor cord is optional and not supplied with cooler. / *Cable eléctrico del motor de 230V es opcional y no se envía con el enfriador.*

NOTE: Standard hardware items may be purchased from your local hardware store.

NOTA: Artículos de uso corriente pueden comprarse en la ferretería de su localidad.