

PRODUCT SPECIFICATIONS

Elkay Quartz Luxe® 25" x 22" x 9-1/2", Single Bowl Drop-in Sink. Proprietary manufacturing process that combines natural quartz with high performance UV-stable acrylic resins results in an impact resistant, nonporous and heat-, scratch-, stain- and fade-resistant surface. Naturally sound deadening and Rear Center drain placement.



| | |
|------------------------------|---|
| Installation Type: | Drop-in |
| Material: | Quartz |
| Finish: | Caviar (CA), Charcoal (CH), Chestnut (CN), Parchment (PA), Ricotta (RT) |
| Number of Bowls: | 1 |
| Sink Dimensions: | 25" x 22" x 9-1/2" |
| Bowl 1 Dimensions: | 22-5/16" x 16-7/16" x 9-1/2" |
| Drain Size: | 3-1/2" (89mm) |
| Drain Location: | Rear Center |
| Minimum Cabinet Size: | 30" |
| Mounting Hardware: | Part # 64090404 included for countertops up to 1-3/4" (44mm) thick |
| Template Included: | No |
| Cutout Template #: | 0000001438 |

Template is available for download at [elkay.com](#). CAD software will be required to open the template.

Cutout Dimensions for Drop-in Installation:

24-3/8" x 21-3/8" (619mm x 543mm) with 11/16" (17mm) corner radius

Special Note: Reserve Selection products are sold exclusively, in-store and online, through authorized wholesalers.



Caviar (CA) Charcoal (CH) Chestnut (CN) Parchment (PA) Ricotta (RT)

AMERICAN PRIDE. A LIFETIME TRADITION.

Like your family, the Elkay family has values and traditions that endure. For almost a century, Elkay has been a family-owned and operated company, providing thousands of jobs that support our families and communities.

Product Compliance: CSA B45.5/IAPMO Z124



Sinks are listed by IAPMO® as meeting the applicable requirements of the Uniform Plumbing Code®, International Plumbing Code®, and National Plumbing Code of Canada.

[Clean and Care Manual \(PDF\)](#)
[Installation Instructions \(PDF\)](#)
[Warranty \(PDF\)](#)

1-1/2" (38mm) Diameter Faucet Holes on 4" (102mm) Centers are Pre-Scored. Installer can punch up to 5 faucet holes.

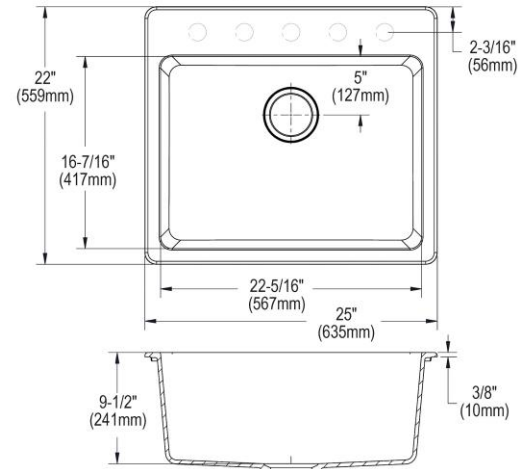

PART: _____ QTY: _____

PROJECT: _____

CONTACT: _____

DATE: _____

NOTES: _____



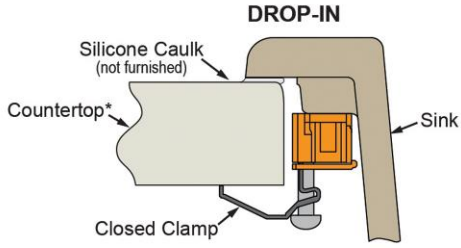

APPROVAL: _____

In keeping with our policy of continuing product improvement, Elkay reserves the right to change product specifications without notice. Please visit [elkay.com](#) for the most current version of Elkay product specification sheets. This specification describes an Elkay product with design, quality, and functional benefits to the user. When making a comparison of other producers' offerings, be certain these features are not overlooked.

Installation Profile:

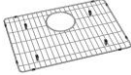

*Maximum thickness for use of hold down system is 1-3/4" (44mm).

| Optional Accessories | | |
|------------------------------|---|---|
| LKOBG2217SS | Elkay Stainless Steel 19-13/16" x 13-13/16" x 1-1/4" Bottom Grid Spec Sheet (PDF) |  |
| LKCBEG2217HW | Elkay Hardwood 23-1/4" x 17-3/8" x 1" Cutting Board Spec Sheet (PDF) |  |
| LK99 | Elkay Deluxe 3-1/2" Drain Type 304 Stainless Steel Body Strainer Basket Rubber Seal and Tailpiece Spec Sheet (PDF) |  |
| LKQD35 | Elkay Polymer 3-1/2" Disposer Flange with Removable Basket Strainer and Rubber Stopper Spec Sheet (PDF) |  |
| LKQS35 | Elkay Polymer 3-1/2" Drain Fitting with Removable Basket Strainer and Rubber Stopper Spec Sheet (PDF) |  |

In keeping with our policy of continuing product improvement, Elkay reserves the right to change product specifications without notice. Please visit elkay.com for the most current version of Elkay product specification sheets. This specification describes an Elkay product with design, quality, and functional benefits to the user. When making a comparison of other producers' offerings, be certain these features are not overlooked.