

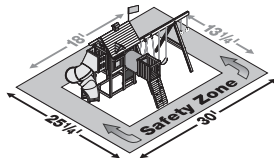

ALLPRO

Safety Guide & Assembly Instructions



Featured Components (purchase separately):



PS 8876



PS 7958



PS 7980



PS 8821

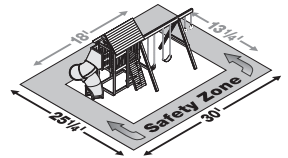

Featured Components (purchase separately):



PS 7676



PS 7946



PS 8821

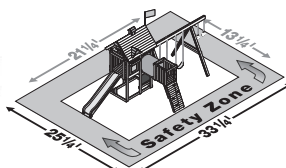

Featured Components (purchase separately):



PS 7676



PS 7946



PS 7980



PS 8876



PS 8813

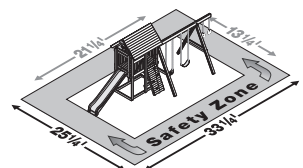

Featured Components (purchase separately):



PS 7676



PS 7946



PS 8813

We're Here To Help!

Call Toll Free **1-888-752-9782**
Customer Service: Monday - Friday, 8:00 A.M. to 5:00 P.M. C.S.T.

PS 7483

SAFETY

- This product is intended for single-family residential use only, by children ages two to ten and a maximum weight of 105 pounds. Any recommendation over 10 years of age or 105 pounds exceeds the upper limits specified in the American Society for Testing and Materials (ASTM) Home Playground Safety Standard. In order for PlayStar to comply with the ASTM Standard, we cannot recommend anyone above these limits.
- It is a misuse of this product when installed or used in places of public assembly such as schools or parks.
- Follow the instructions provided, do not alter its design in any way.
- Construction requires at least two adults capable of heavy lifting.
- Thoroughly read all safety instructions before beginning.
- Children must remain clear of construction site until this product is properly installed and ready for use.
- Save these instructions in the event the manufacturer has to be contacted.

The Consumer Product Safety Commission provides the following consumer information for your Home Playground Equipment

Select Protective Surfacing

One of the most important things you can do to reduce the likelihood of serious head injuries is to install shock-absorbing protective surfacing under and around your play equipment. The protective surfacing should be applied to a depth that is suitable for the equipment height in accordance with ASTM F1292. There are different types of surfacing to choose from; whichever product you select, follow these guidelines:

NOTE: Do not install home playground equipment over concrete, asphalt, packed earth, grass, carpet or any other hard surface. A fall onto a hard surface can result in serious injury or death to the equipment user. Grass and dirt are not considered protective surfacing because wear and environmental factors can reduce their shock absorbing effectiveness. Carpeting and thin mats are generally not adequate protective surfacing. Ground level equipment -- such as a sandbox, activity wall, playhouse or other equipment that has no elevated play surface -- does not need any protective surfacing.

Loose-Fill Materials

PlayStar Playsets require fall-height protection from eight feet.

- Maintain a minimum depth of 9 inches of loose-fill materials such as wood mulch / chips, engineered wood fiber (EWF), or shredded/recycled rubber mulch for

equipment up to 8 feet high. NOTE: An initial fill level of 12 inches will compress to about a 9-inch depth of surfacing over time. The surfacing will also compact, displace, and settle, and should be periodically refilled to maintain at least a 9-inch depth.

- Use containment, such as digging out around the perimeter and/or lining the perimeter with landscape edging. Don't forget to account for water drainage.
- Check and maintain the depth of the loose-fill surfacing material. To maintain the right amount of loose-fill materials, mark the correct level on play equipment support posts. That way you can easily see when to replenish and/or redistribute the surfacing.
- **Do not** install loose fill surfacing over hard surfaces such as concrete or asphalt.

Poured-In-Place Surfaces or Pre-Manufactured Rubber Tiles

You may be interested in using surfacing other than loose-fill materials -- like rubber tiles or poured-in-place surfaces.

- Installations of these surfaces generally require a professional and are not "do-it-yourself" projects.
- Review surface specifications before purchasing this type of surfacing. Ask the installer/manufacturer for a report showing that the product has been tested to the following safety standard: ASTM F1292 *Standard Specification for Impact Attenuation of Surfacing Materials within the Use Zone of Playground Equipment*. This report should show the specific height for which the surface is intended to protect against serious head injury.

This height should be equal to or greater than the *fall height* - vertical distance between a designated play surface (*elevated surface for standing, sitting, or climbing*) and the protective surfacing below - of your play equipment.

- Check the protective surfacing frequently for wear.

Placement

Proper placement and maintenance of protective surfacing is essential.

Be sure to;

- Extend surfacing at least 6 feet from the equipment in all directions.
- For to-fro swings, extend protective surfacing in front of and behind the swing to a distance equal to twice the height of the top bar from which the swing is suspended.

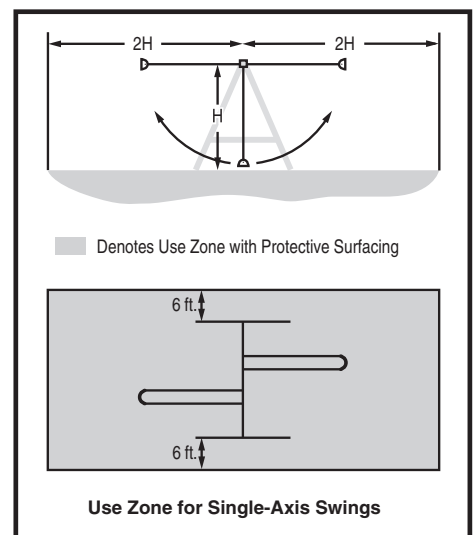

SAFETY

INSTALLATION:

1. Follow the instructions provided, do not alter its design in any way.
2. Place the equipment on level ground, not less than 6' (1.8m) from any structure or obstruction such as a fence, garage, house, overhanging branches, laundry lines or electrical wires. If the area where you will be installing your playset is not level, you must make it level.
3. Playsets must be anchored to the ground. Follow the anchoring instructions provided with your building kit. If soil conditions permit anchors to be pulled out easily, such as in sandy soil conditions, cementing is required.
4. Tighten all bolts securely to the intended member then cut off all protruding threaded ends of bolts with a hack saw **flush to the end of the nut** and remove sharp edges with a metal file.

WARNING: Children must not use the playset until properly installed and proper shock-absorbing surfacing material is in place.

OPERATION: *Observing and following statements and warnings reduces the likelihood of serious or fatal injury.*

1. On-site adult supervision is recommended for children of all ages.

2. Only one child, for each single planned seat or single planned activity should be allowed on this set at one time, with a maximum weight of **105 pounds** for each child.

WARNING: You must teach children the following:

- A. **Not** to walk close to, in front of, behind, or between moving items.
 - B. **Not** to twist swing chains or ropes or loop them over the top support bar since this may reduce the strength of the chain or rope.
 - C. **Avoid** swinging empty seats.
 - D. **To Sit** in the center of the swings with their full weight on the seats.
 - E. **Not** to use the equipment in a manner other than intended.
 - F. **Not** to get off equipment while it is in motion.
 - G. **Not** to climb when equipment is wet.
 - H. **Not** to attach items to the playground equipment that are not specifically designed for use with the equipment such as, but not limited to, jump ropes, clothesline, pet leashes, cables and chain as they may cause a strangulation hazard.
1. **Remove** bike or other sports helmet before playing on the playground equipment.
 3. Verify that suspended climbing ropes are secured at both ends and that they cannot be looped back on themselves.

4. Dress children appropriately and do not allow them to wear inappropriate items, such as but not limited to, loose fitting clothing, hood and neck draw strings, scarves, cord-connected items, capes, and ponchos. These items can cause death by strangulation. Provide well-fitting and full enclosure footwear. Examples of inappropriate footwear are clogs, flip flops, and sandals.
5. Verify that all suspended swinging components have at least 8" clearance between the lowest point of component and top of shock-absorbing surfacing material.

WARNING: Lawn swings are designed for use by children two years of age and older. Use by children under the age of two can result in entrapment between the seat and backrest. **NEVER** place children in a rearward facing position or with legs between the seat and backrest because the child's body may pass through the opening causing entrapment of the child's head.

DISPOSAL:

When the playset is to be retired from service, disassemble and dispose of in such a way that no unreasonable hazards will exist. Follow your local disposal requirements.

ANNUAL MAINTENANCE CHECKLIST

(Copy this section as needed and maintain for your records or visit www.playstarinc.com/maintenance)



At the beginning of play season: Date: _____

- Tighten all hardware.
- Lubricate all metallic moving parts per manufacturer's instructions.
- Check all protective coverings on bolts, pipes, edges, and corners. Replace if they are loose, cracked, or missing.
- Check all moving parts including swing seats, ropes, cables, and chains for wear, rust, or other deterioration. Replace as needed.
- Check metal parts for rust. If found, sand and repaint using a nonlead-based paint meeting the requirements of 16 CFR 1303.
- Check all wood members for deterioration and splinters. Sand down splinters and replace deteriorating wood members.
- Reinstall any plastic parts, such as swing seats or any other items that were removed for the cold season.
- Rake and check depth of loose fill protective surfacing materials to prevent compaction and to maintain appropriate depth. Replace as necessary.

Twice a month during play season: Date: _____

- Tighten all hardware.
- Check all protective coverings on bolts, pipes, edges, and corners. Replace if they are loose, cracked, or missing.
- Rake and check depth of loose fill protective surfacing materials to prevent compaction and to maintain appropriate depth. Replace as necessary.

Once a month during play season: Date: _____

- Lubricate all metallic moving parts per manufacturer's instructions.
- Check all moving parts including swing seats, ropes, cables, and chains for wear, rust, or other deterioration. Replace as needed.

At the end of each play season or when the temperature drops below 0° F: Date: _____

- Remove plastic swing seats and other items as specified by the manufacturer and take indoors or do not use.
- Rake and check depth of loose fill protective surfacing materials to prevent compaction and to maintain appropriate depth. Replace as necessary.

Owner shall be responsible for maintaining the legibility of any warning labels.

If any of these conditions exist, call 1-888-752-9782 for ordering information.

Clean plastic components with warm water and a mild detergent such as dish soap.

COMPONENTS INCLUDED (not actual size)

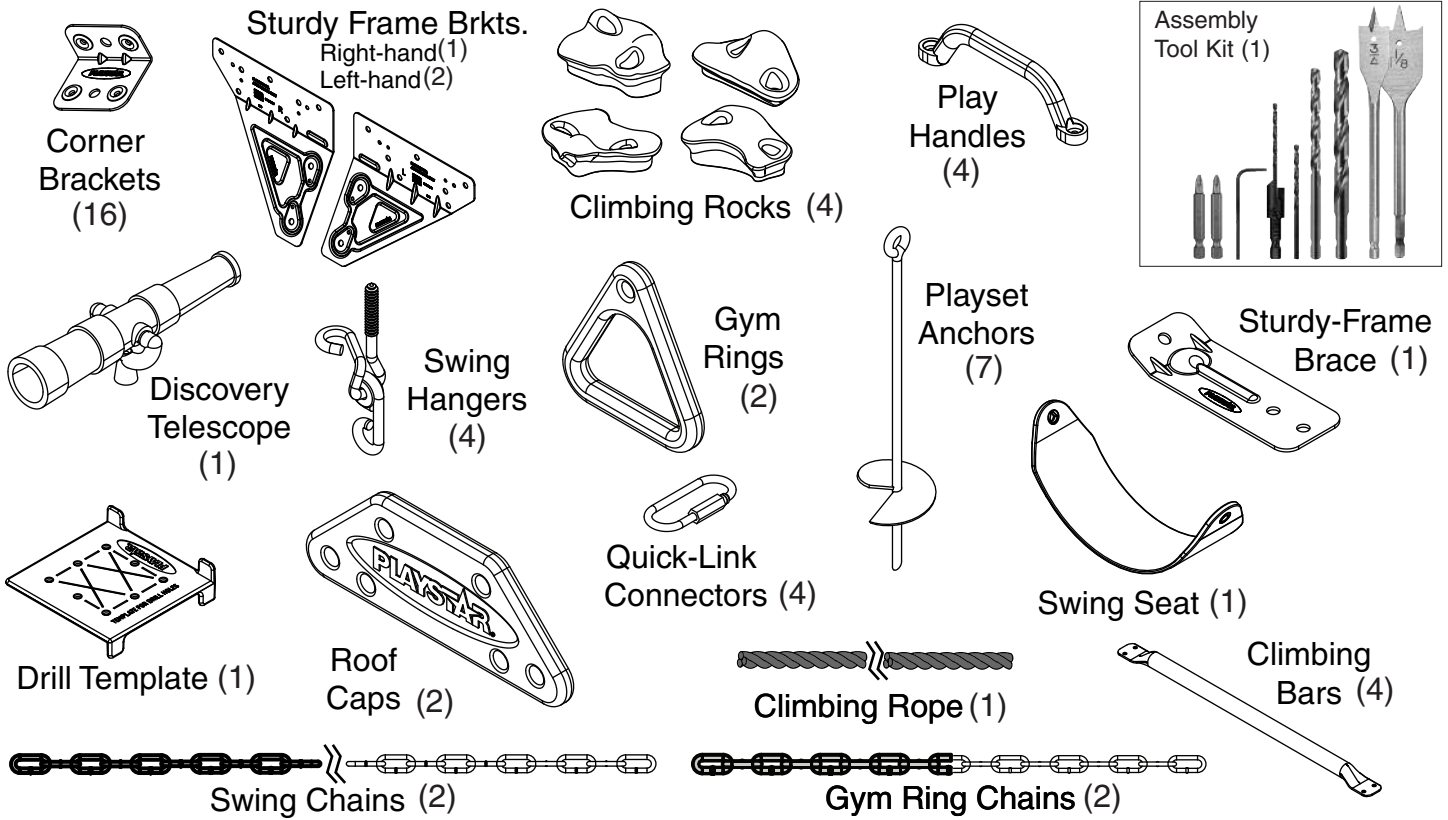

TOOLS REQUIRED

- | | | | |
|--------|-------------------|-----------------------------------|----------------------|
| Level | Adjustable Wrench | Screwdriver (regular or phillips) | Sawhorses (optional) |
| Square | Socket Wrench | Tape Measure | Shovel |
| Pencil | 9/16" Socket | Safety Glasses | Ladder |
| Hammer | Drill | | |

HARDWARE INCLUDED (shown actual size)

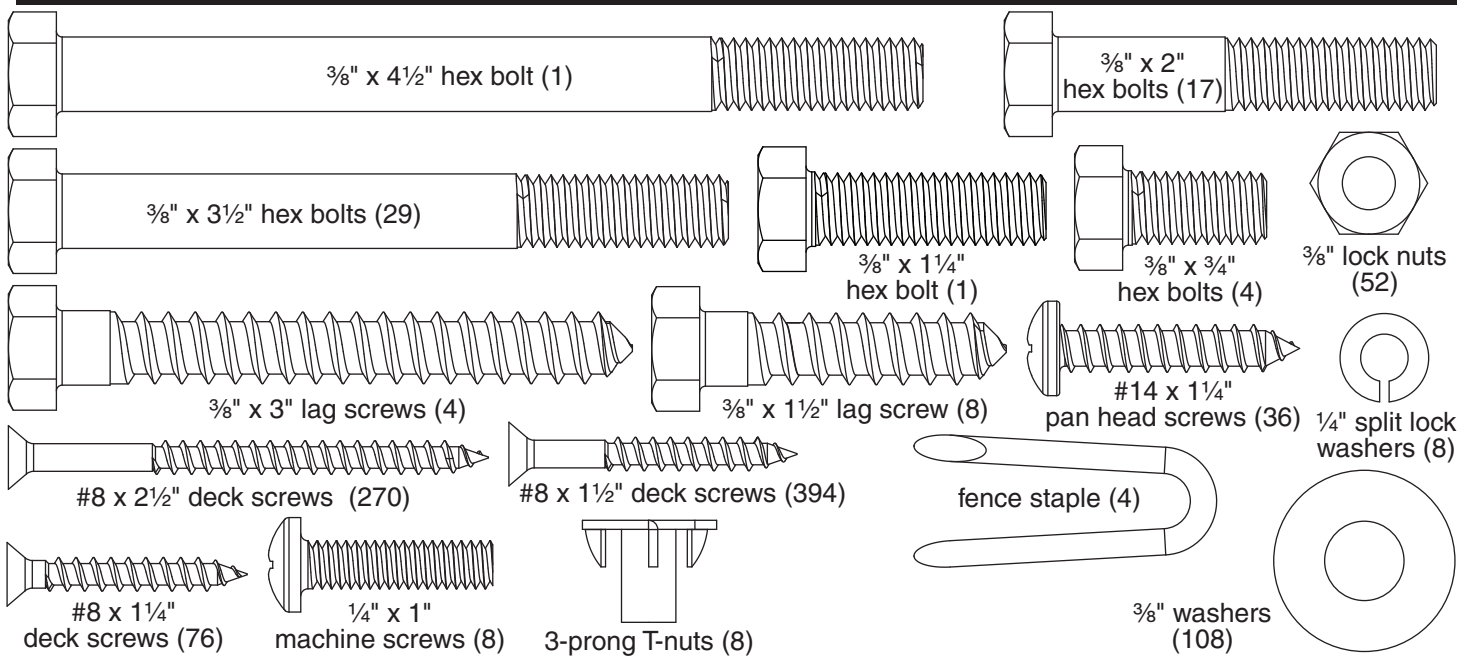

BOARDS INCLUDED

Before starting to assemble your playset, make sure all boards and hardware are identified and stacked by size. This will improve your assembly time.

All boards are identified by “nominal” dimensions. The “actual” width and thickness of boards will vary. During assembly process, hide the marked end of the board to the inside so it is not visible on your completed playset.

The 1" x 4" and 1" x 6" boards may not be predrilled. To make the installation process easier, predrill the boards using the Drill Patterns shown. A guide on “How to Use the Drill Template” (which is included in this kit) can be found on pages 7 and 8.

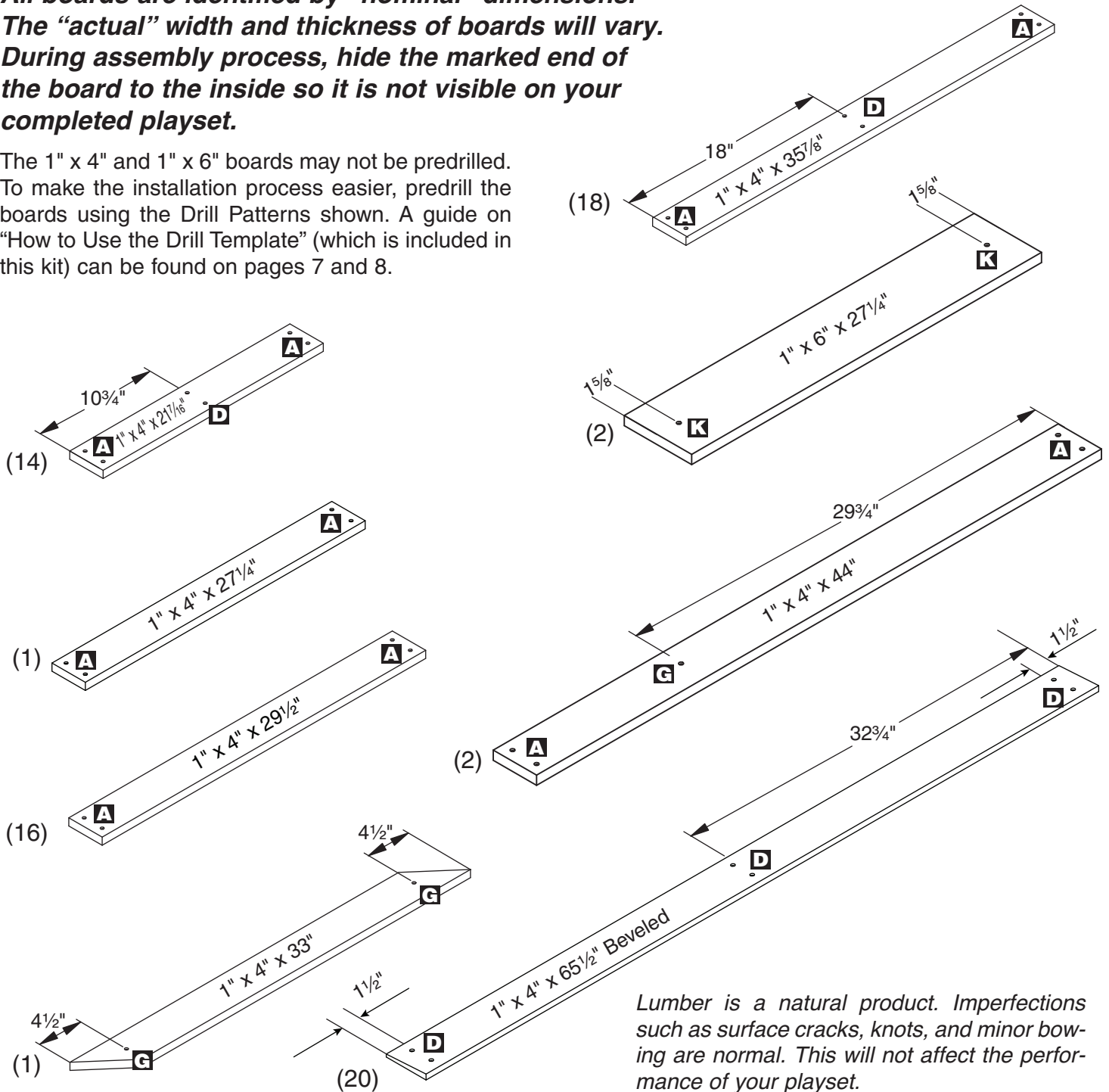

Lumber is a natural product. Imperfections such as surface cracks, knots, and minor bowing are normal. This will not affect the performance of your playset.

Thinner boards have a tendency to bow more than thicker boards. However, all minor bowing can be straightened when attaching the boards during the assembly process.

BOARDS INCLUDED

All boards are identified by “nominal” dimensions. The “actual” width and thickness of boards will vary. During assembly process, hide the marked end of the board to the inside so it is not visible on your completed playset.

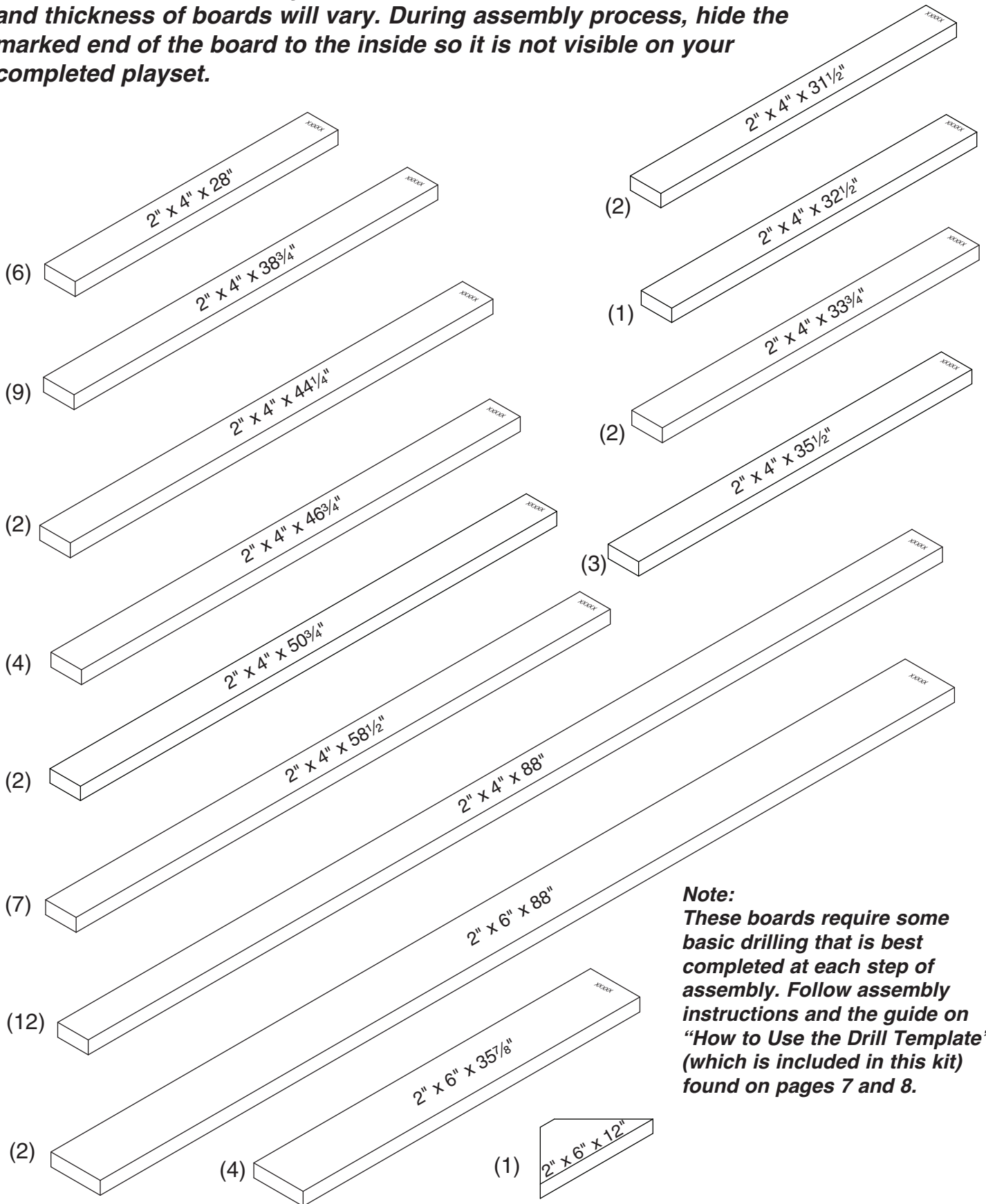

Note:
 These boards require some basic drilling that is best completed at each step of assembly. Follow assembly instructions and the guide on “How to Use the Drill Template” (which is included in this kit) found on pages 7 and 8.