

Model No. BO3710 FINISHING SANDER

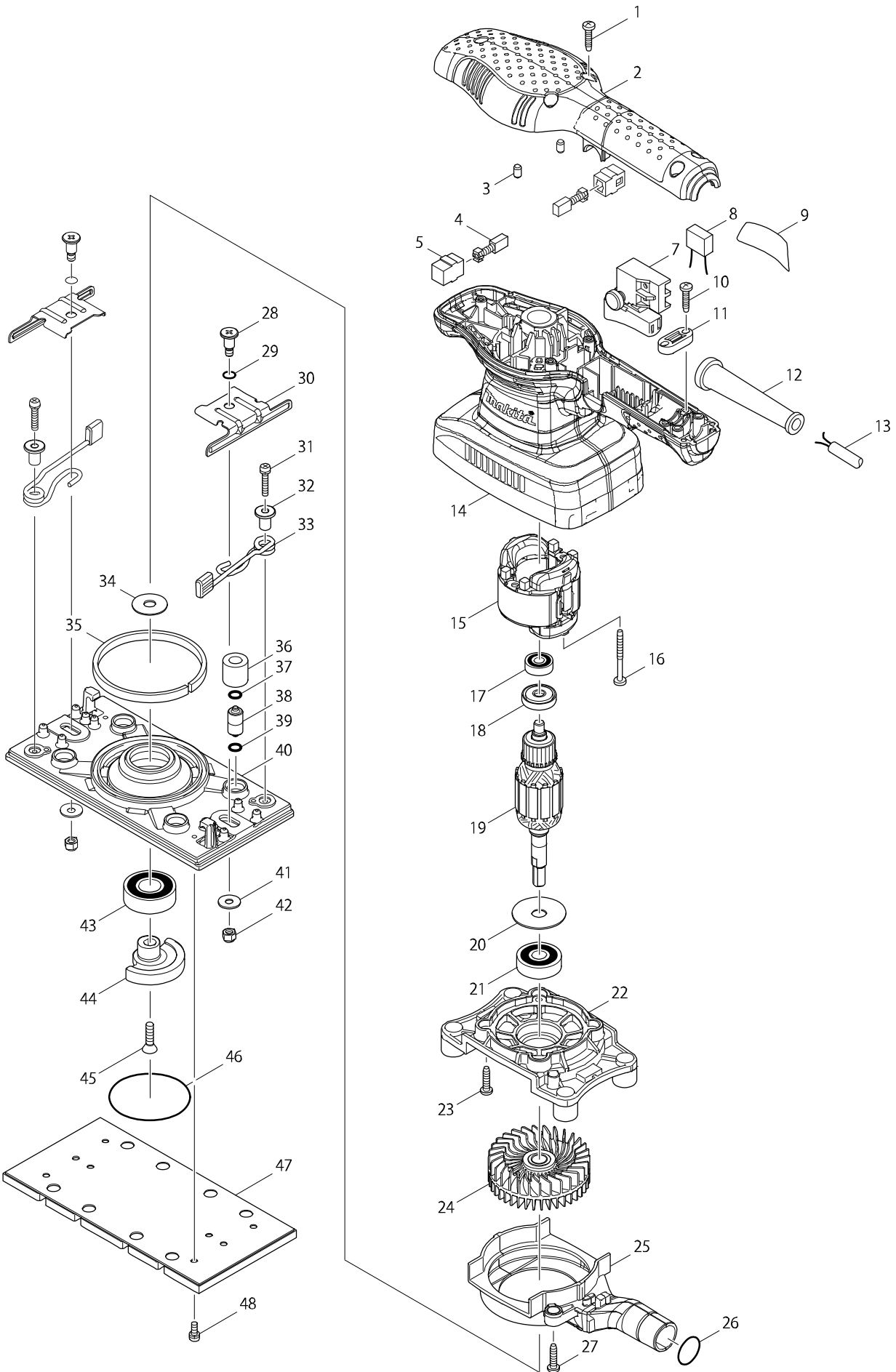

Model No. BO3710 FINISHING SANDER

Item	Parts No.	Description	I/C	Qty	N/O	Opt. 1	Opt. 2	Note
001	265995-6	TAPPING SCREW 4X18		5				
002	451268-5	TOP COVER		1				
003	263002-9	RUBBER PIN 4		2				
004	191627-8	CARBON BRUSH CB-64		1				
005	643552-4	BRUSH HOLDER 5-8		2				
007	651286-5	SWITCH SGEL206C-5		1				
009	866995-5	BO3710 NAME PLATE		1				
010	265995-6	TAPPING SCREW 4X18		2				
011	687123-7	STRAIN RELIEF		1				
012	682569-2	CORD GUARD 8-85		1				
013	692006-8	POWER SUPPLY CORD 1.0-2-2.0		1				
014	451270-8	MOTOR HOUSING		1				
015	593703-8	FIELD ASSEMBLY 220-240V		1				
C10	654037-5	INSULATED TERM. FT1.25-M3		2	*			
C11	654037-5	INSULATED TERM. FT1.25-M3	O	2				
016	266048-4	TAPPING SCREW 4X40		2				
017	210062-2	BALL BEARING 607ZZ		1				
018	681652-2	INSULATION WASHER		1				
019	515784-2	ARMATURE ASSEMBLY 240V		1				
D10		INC. 17,18,20,21						
020	253180-3	FLAT WASHER 10		1				
021	211087-9	BALL BEARING 6200DDW		1				
022	451266-9	BEARING BOX		1				
023	265995-6	TAPPING SCREW 4X18		4				
024	240117-9	FAN 68		1				
025	451267-7	FAN GUIDE		1				
026	213315-8	O RING 19		1				
027	265995-6	TAPPING SCREW 4X18		2				
028	266511-7	+ FLAT FILLISTER HEAD SCREW M5		2				
029	213045-1	O-RING 6		2				
030	346102-1	PAPER CLAMP		2				
031	911136-9	PAN HEAD SCREW M4X20		2				
032	310300-3	SPRING GUIDE		2				
033	162279-2	LEVER COMPLETE		2				
034	267353-2	FLAT WASHER 8		1				
035	423389-3	SPONGE 6X230X3		1	*			
035-1	423469-5	SPONGE 6X105X3	O	1				
036	424056-3	SPONGE SLEEVE 9		4				
037	213983-7	O RING 4		4				
038	318151-8	FOOT		4				
039	213983-7	O RING 4		4				
040	318484-1	BASE		1	*			
040-1	318484-1	BASE	X	1				
041	253807-5	FLAT WASHER 5		2				
042	252103-8	HEX. LOCK NUT M5-8		2				
043	211228-7	BALL BEARING 6202DDW		1				
044	310301-1	BALANCER		1				
045	912222-9	COUNTERSUNK HEAD SCREW M5X16		1				

