

Pure Freude
an Wasser



new



SMART DESIGN

GROHE Rapido SmartBox

GROHE SmartControl

CONTENTS

ADVANTAGES OF CONCEALED	4
FEATURES IN A GLANCE	6
BENEFITS IN FRONT OF THE WALL	8
BENEFITS BEHIND THE WALL	16
DESIGN OPTIONS	28
TECHNOLOGY OPTIONS	36
TECHNOLOGY	42
COMPLETE RANGE	52

GETTING BETTER ALL THE TIME

AT GROHE WE ARE CONTINUALLY LOOKING FOR NEW AND BETTER SOLUTIONS.

Our experts in the fields of design and engineering constantly strive to achieve more effective and efficient ways to control water and more beautiful ways to transport it. To give our customers more possibilities to enjoy water. And our installers and planners are constantly coming up with better and more effective ways of working with it.

GROHE SmartControl Concealed and the GROHE Rapido SmartBox together offer a huge number of benefits. Stay with us to find out more.

SIMPLY OBVIOUS

THE HIDDEN ADVANTAGES OF CONCEALED TECHNOLOGY

Space is a valuable commodity and often in short supply. It becomes a challenge for planners and installers to use it effectively. No easy task, especially in the shower area where space is often at a premium.

With its hidden installation and exceedingly slim design, GROHE SmartControl Concealed offers more space under the shower without compromising on functionality or comfort. It also offers additional benefits of a practical kind: cleaning it becomes faster and more convenient, thanks to the flat, streamlined design.

Flexibility of design: GROHE SmartControl Concealed also offers a multitude of design variants. A wide selection of suitable trim sets and showers ensures that the style chosen for the bathroom extends seamlessly into the shower area. Concealed technology: more in it for you.



SIMPLY MORE ADVANTAGES

One rough-in runs up to three shower/bath filler functions with just one trim

Efficient piping thanks to bottom inlets

Wall plates adjustable by six degrees

Only 75 mm minimum installation depth

Optional service stops for retrofit

Always compliant with retrofit backflow protection

Easy job-side mounting, no bench vice needed



Control up to three shower functions for a better shower experience

Intuitive operation and perfect control of water volume through SmartControl

Concealed technology and elegant super slim design – 43 mm – for more space under the shower

SIMPLY SMARTER
ALL THE BENEFITS IN
FRONT OF THE WALL





LESS IS MUCH MORE – ONE PLATE DOES IT ALL

CONTROL UP TO THREE SHOWERS WITH JUST ONE TRIM

Today's trend is for a multiple shower experience that offers more than simple bath/shower combinations. The downside is that for this to work, you need two rough-ins and two trims to control a hand shower and a two-spray head shower: up until now. GROHE Rapido SmartBox and GROHE SmartControl Concealed make it simple. With just one rough-in and one trim, it is possible to enjoy two head shower functions simultaneously. Featuring up to three SmartControl valves plus thermostat or mixer in one trim, GROHE SmartControl Concealed means half the work for three times the showering pleasure.

The pleasure of using two head shower sprays is enhanced by the Rainshower 360 and the new Rainshower 310 head showers. Designed to be the perfect match, they deliver an unmissable shower sensation.

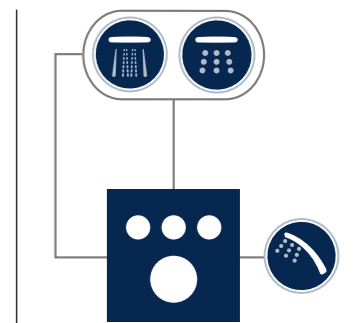

**JUST ONE
ROUGH-IN
AND ONE
TRIM NEEDED**



TURN UP THE VOLUME – OR DOWN IF YOU PREFER



GROHE SmartControl offers not just a choice of shower sprays, but also the precise control of water flow.

GROHE SmartControl features an integrated volume control for an individual shower experience. A simple push of a button starts or stops the desired shower. And just a turn of the dial allows for precise control of water volume. Thanks to the clear symbols on the buttons, operating them is simple and intuitive.



**ALL PUSH
VALVES WITH
VOLUME
CONTROL**



METAL PLATE, ERGONOMIC GRIP
 In keeping with its sleek design, the GROHE SmartControl Concealed uses premium materials. Its ergonomic buttons have a knurled grip for ease of use.

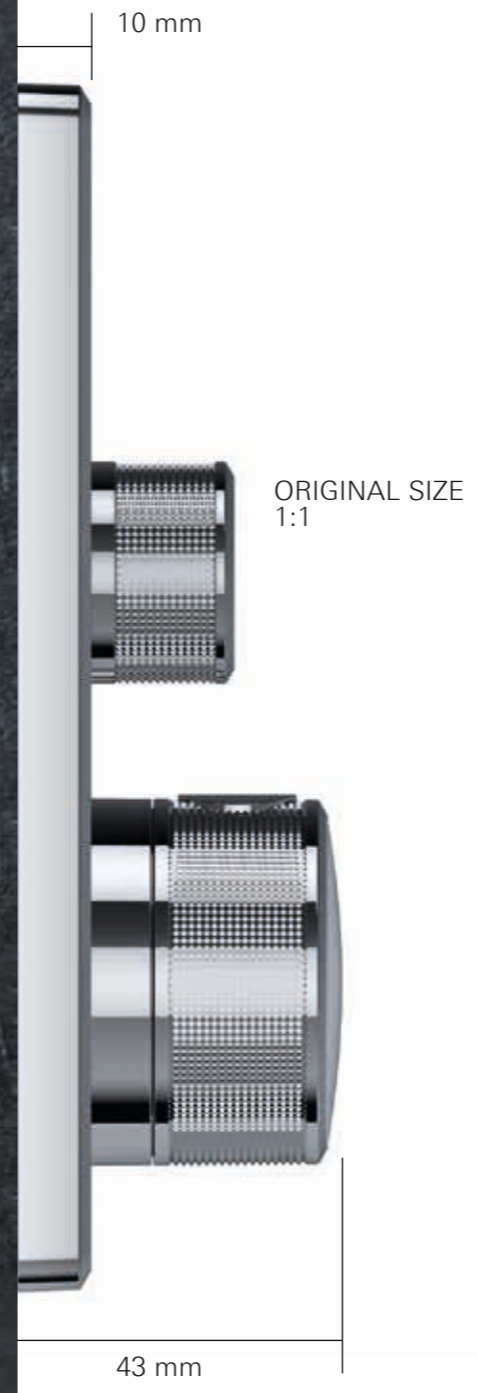

SLIM IS THE NEW BEAUTIFUL

43 MM TOTAL OUTREACH

No matter what the installation depth of the rough-in is, the total height of the trim never exceeds 43 mm. The GROHE SmartControl Concealed combines space-saving convenience in the shower and slim good looks.

THINNER WALL PLATES

With a height of only 10 mm, its super slim design makes the GROHE SmartControl Concealed wall plate both elegant and space saving.

HIDDEN SEALING SYSTEM

The GROHE SmartControl Concealed has an integrated sealing system, completely eliminating water behind the wall.

SYMBOLS CAN BE CHANGED

The control knobs come with a range of different symbols, representing the different shower options. These symbols are clear and recognisable and their functionality distinct. They can be individually configured and also easily exchanged if required.



43 MM SLIM DESIGN

SIMPLY SIMPLER
EVEN MORE BENEFITS
BEHIND THE WALL



ONE CAN DO THE JOB OF TWO

ROUGH-IN WITH 3 OUTLETS

With three outlets for a wider range of shower options, the GROHE Rapido SmartBox can take on the job where two rough-ins are normally needed. Which is a huge savings in work and effort.

ALL PORTS WITH 1/2 INCH STANDARD

The GROHE Rapido SmartBox makes adapters practically redundant. It has 1/2" connections, made to fit all standard pipes. Where other rough-ins with 3/4" outlets are made to fit the exception not the rule, the GROHE Rapido SmartBox is designed to fit 90% of all pipes. Smart, isn't it?

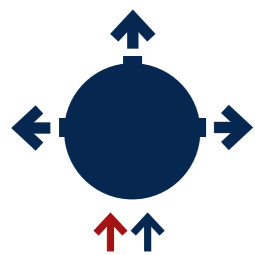

5 PORTS
1/2 INCH

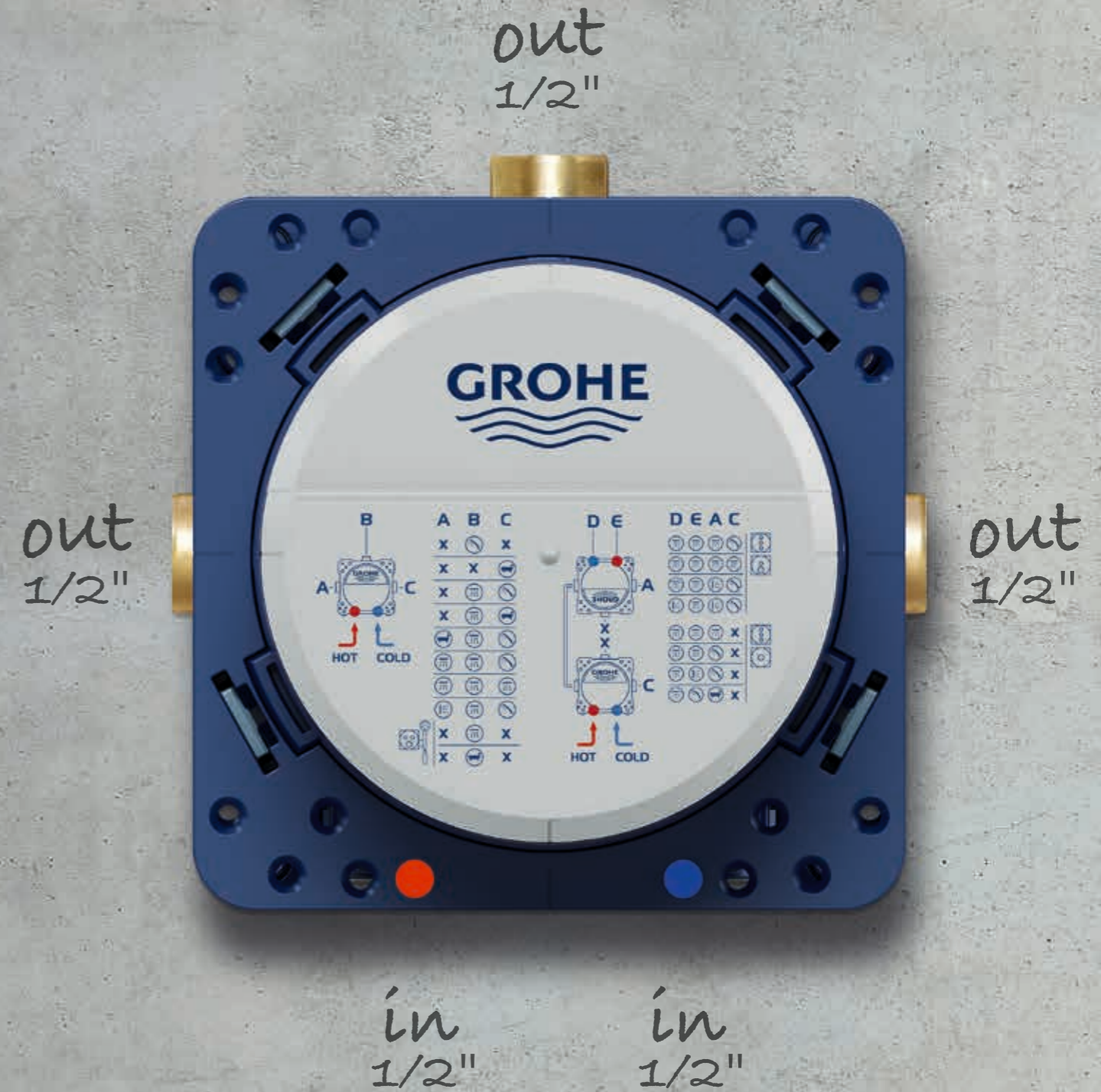

in
1/2"

in
1/2"



EFFICIENCY FROM THE BOTTOM UP

BOTTOM INLETS FOR EFFICIENT PIPING

Efficient piping leads to efficient installation. The GROHE Rapido SmartBox comes with bottom inlets, enabling a direct connection to the hot and cold water supply. That makes 90° fittings a thing of the past. Why take a detour when you can take the direct route?

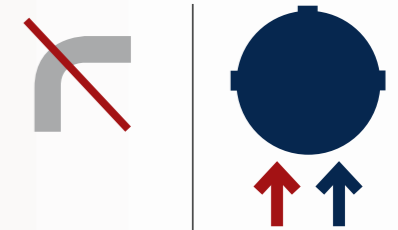

NO 90°
FITTINGS
NEEDED

BOTTOM
INLETS



SWEATING THE SMALL STUFF MADE EASY

SUBSEQUENTLY ADJUSTABLE UP TO SIX DEGREES

Doing a perfect job comes down to getting even the smallest detail perfect. And once a job is finished, it's usually hard to adjust mistakes. Not with the GROHE wall plates. They can be subsequently adjusted by up to six degrees – thanks to slotted holes in the function unit – to allow for perfect alignment with tiles and tile joints. No drilling, no risk of damage. Just a job well done.

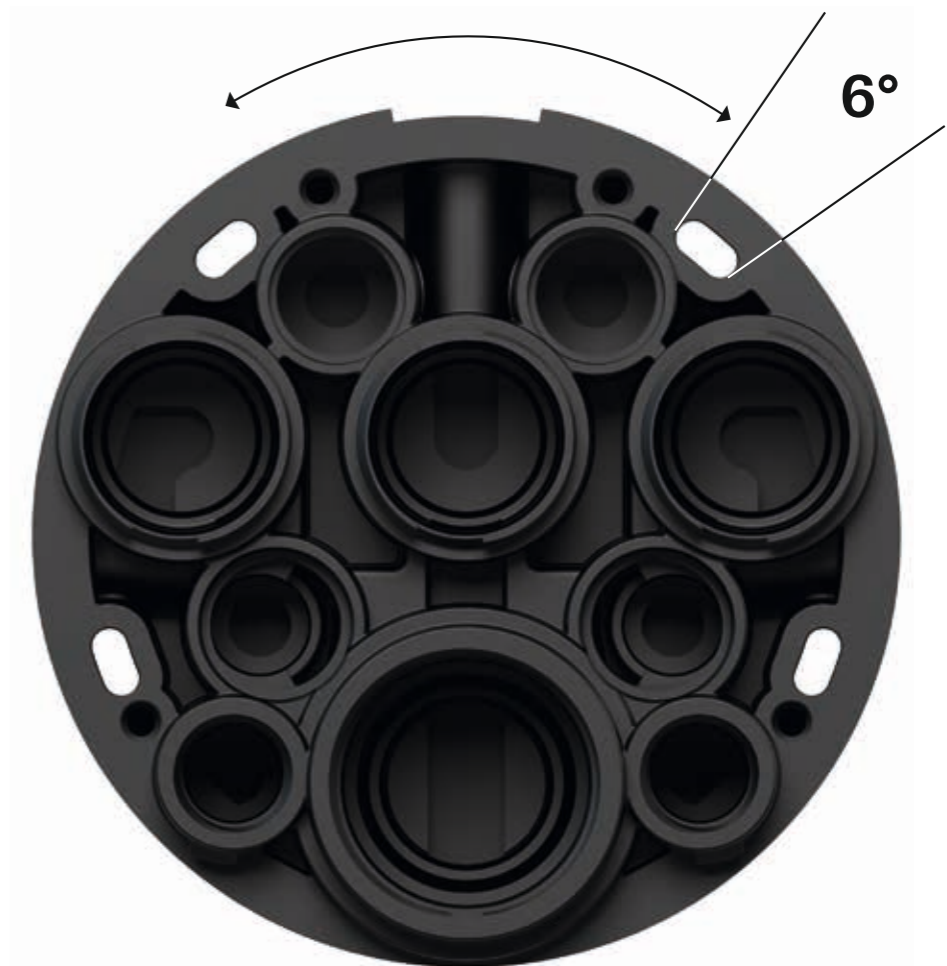

SUBSEQUENTLY
ADJUSTABLE

A NEAT SOLUTION: BACKFLOW PROTECTION FOR RETROFIT

In Europe, every combination with an integrated bath-fill and an overflow unit must comply with the EU norm EN1717, to protect drinking water from contamination. With a simple but clever backflow protection device, the GROHE Rapido SmartBox can be retrofitted to comply with the EU norm.



INTEGRATED
BATH-FILL AND
OVERFLOW UNIT

ALL YOU NEED FOR RETROFITTING

SERVICE STOPS FOR RETROFITTING

With its optional service stops for retrofit, the GROHE Rapido SmartBox gives you full control over the water supply in just a few steps. In case of maintenance work, each outlet in the building can be closed directly and separately - a clear advantage especially in hotels and apartment buildings. Service stops are available as a retrofit option for the basic rough-in and are easily exchangeable.



BACKFLOW
PROTECTION
DEVICE



SERVICE
STOPS FOR
RETROFIT

SIMPLER INSTALLATION: AN IN-DEPTH LOOK

FITS IN EVERY WALL – EVEN THIN ONES

With an installation depth of only 75 mm, the GROHE Rapido SmartBox fits into every kind of wall, even particularly narrow ones. And it can be installed faster and more easily into brick walls.

THE ROUGH-IN THAT'S ALWAYS ON THE JOB

EASY JOB-SIDE MOUNTING – LEAVE THE BENCH VICE AT HOME

GROHE Rapido SmartBox is the smart innovation that enables fast and easy installation of rough-ins. Thanks to brass outlets, which are readily accessible, the rough-in can be mounted using an adjustable spanner or pipe wrench, allowing for efficient, on-site installation.

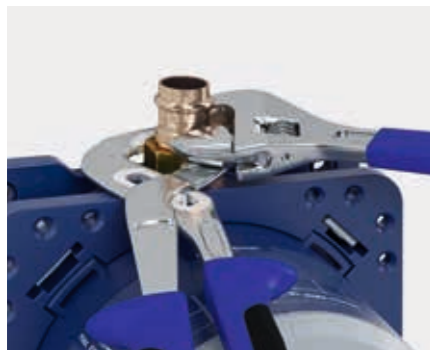

← Only 75 mm →



**ONLY 75 MM
INSTALLATION
DEPTH**



**ONLY PIPE
WRENCH
NEEDED**

SIMPLY MORE FLEXIBLE
DESIGN, UNLIMITED –
ALL THE OPTIONS YOU
COULD ASK FOR



ROUND OR SQUARE?

GROHE SmartControl Concealed comes in two different forms – round and square. It also comes in two stylish finishes: classic chrome and, for a subtly elegant design statement, moon white acrylic glass. Each variant fits perfectly to its matching GROHE design line.



DESIGN OPTIONS

CHROME PLATED METAL

SQUARE



SQUARE DESIGN

RECOMMENDED WITH THE FOLLOWING GROHE BATH LINES

- Allure
- Lineare
- Quadra
- Eurocube
- Eurocube Joy

ROUND



ROUND DESIGN

RECOMMENDED WITH THE FOLLOWING GROHE BATH LINES

- Lineare
- Europlus
- Essence
- Eurodisc Joy
- Eurodisc Cosmopolitan
- Concetto
- Eurostyle Cosmopolitan
- Eurostyle
- Eurosmart Cosmopolitan
- Eurosmart

Full range overview on page 54/55



DESIGN OPTIONS

FACE PLATE IN MOON WHITE ACRYLIC GLASS

SQUARE ACRYLIC GLASS



ROUND ACRYLIC GLASS



SIMPLY THE IDEAL
TEMPERATURE



THERMOSTAT WITH GROHE TURBOSTAT TECHNOLOGY

ALWAYS THE RIGHT TEMPERATURE: FOR ULTIMATE CONVENIENCE AND SAFETY

GROHE TurboStat technology lies at the heart of our Grohtherm thermostats. The thermoelement's unrivalled sensitivity means it delivers water at the desired temperature within a fraction of a second – and keeps it constant for the duration of the shower.

No more time, water and energy wasted getting the temperature right. And if the cold water supply fails, it reacts instantly: the hot water flow will shut off automatically to avoid the risk of scalding.

Grohtherm thermostats come with a 38°C SafeStop button and can be complemented with an additional limiter at 43°C. But more than just controlling the temperature, GROHE TurboStat compensates precisely for fluctuations in pressure for a consistently comfortable shower.



Valve box without
mixing device for
use with concealed
Grohtherm thermostats



SMARTCONTROL MIXER

The ideal entry-level models, GROHE SmartControl Concealed mixers combine SmartControl operation with manual mixer technology. Available with one, two or three control buttons, the mixer cartridges have the advantage of integrated dirt strainers for improved durability and easy service.



MIXER TRIMS



SIMPLY INSTALLED
THE TECHNOLOGY
BEHIND IT ALL



SHIPPING CONTENT MATCHING AND OPTIONAL ACCESSORIES

We gave the GROHE Rapido SmartBox its name for a reason: it is full of clever innovations and able to adapt to every one of your projects. Combine it with any GROHE SmartControl Concealed trim set for a doubly smart solution. Find out more about the many clever details of this rough-in and how to combine it with the range of add-ons.

ROUGH-IN SHIPMENT

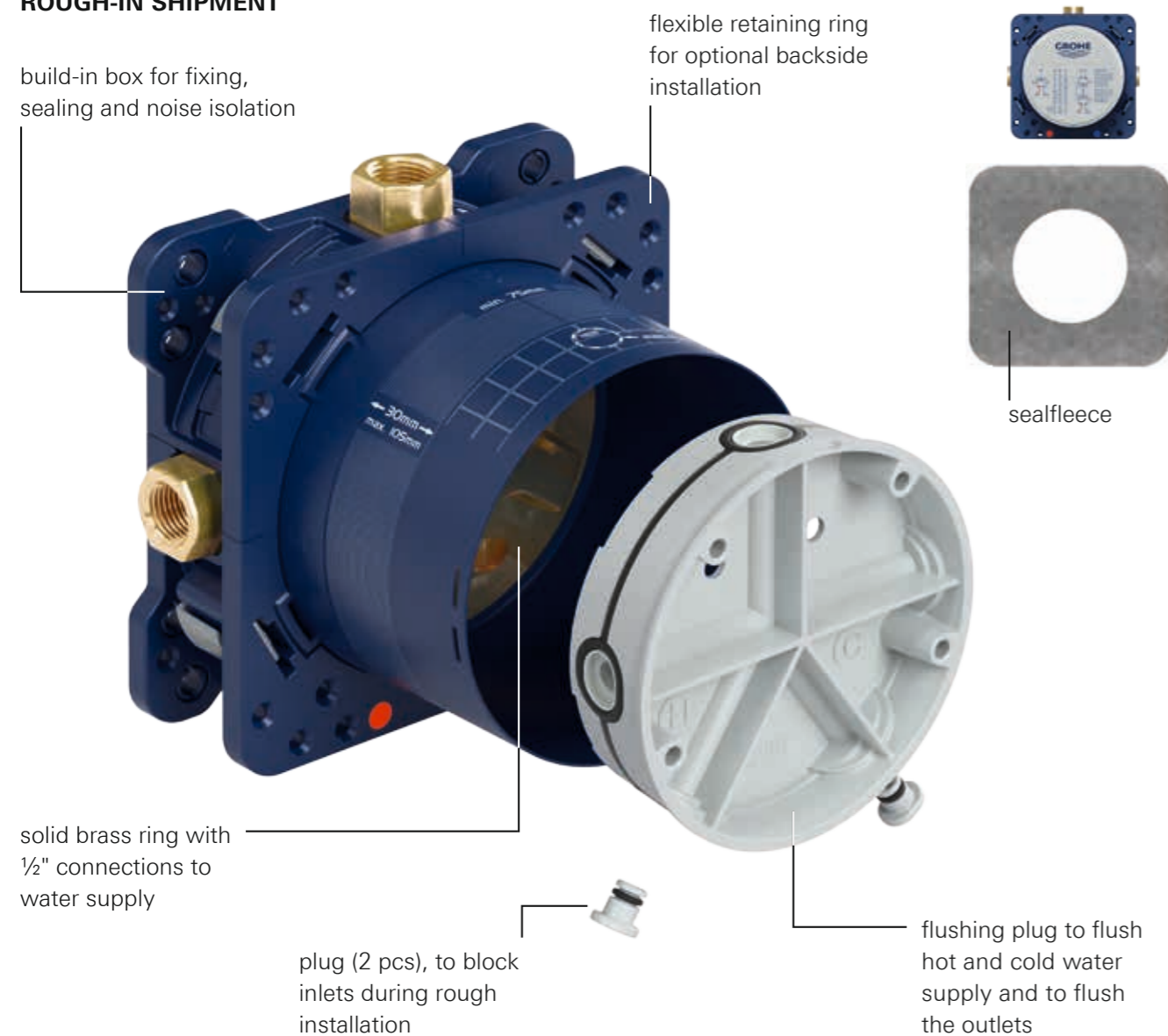

TRIM-SET SHIPMENT

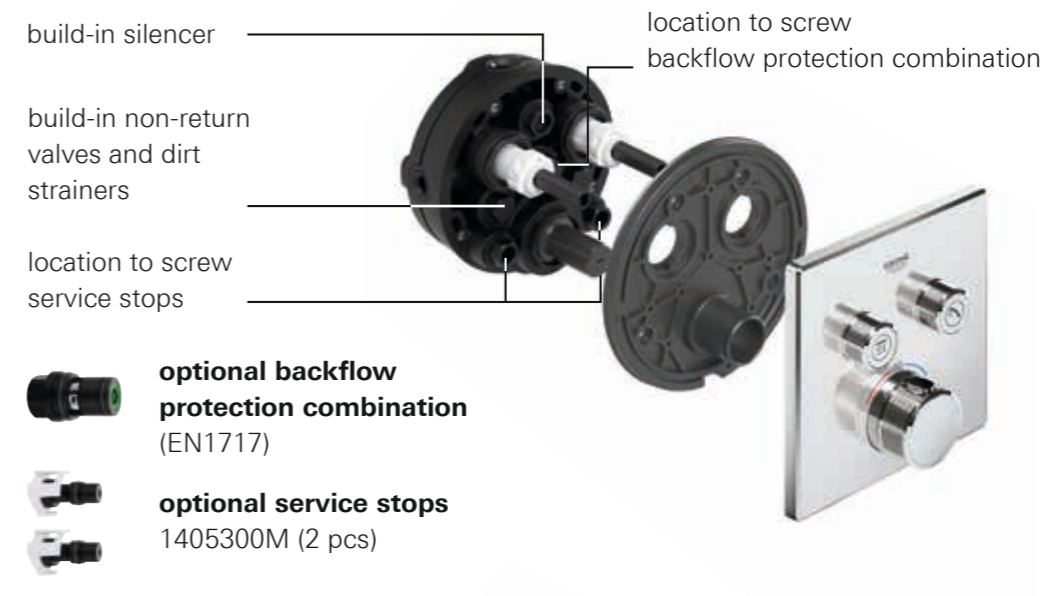

THE ROUGH-IN: MORE ADVANTAGES – NO HASSLE

THE MORE YOU KNOW, THE MORE YOU'LL LOVE IT.

The GROHE Rapido SmartBox has a multitude of well thought through features. If you take a little time to become acquainted with them, you'll quickly realise how the GROHE Rapido SmartBox will enable you to work more efficiently and effectively.



CONFIGURATIONS

SINGLE
(THM + MIXER)

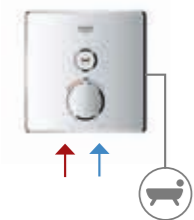

DOUBLE
(THM + MIXER)

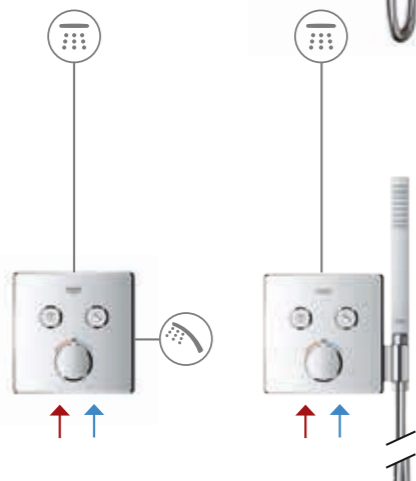
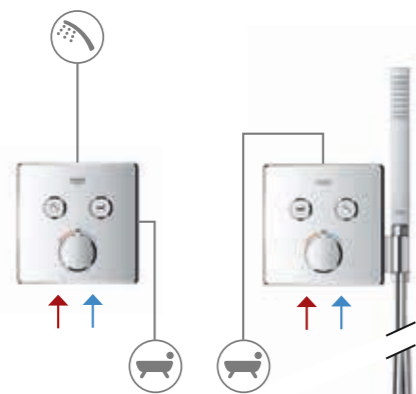

TRIPLE
(THM + MIXER)

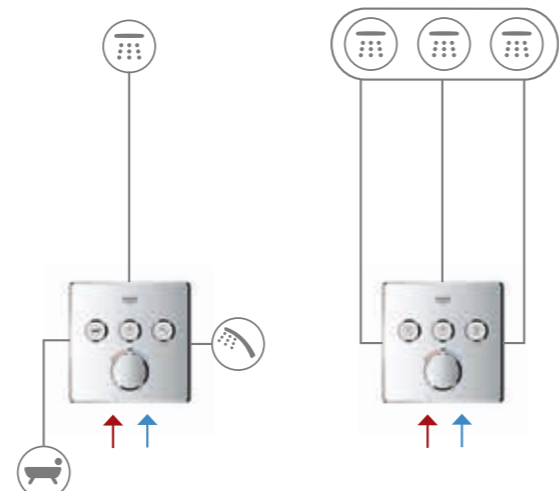
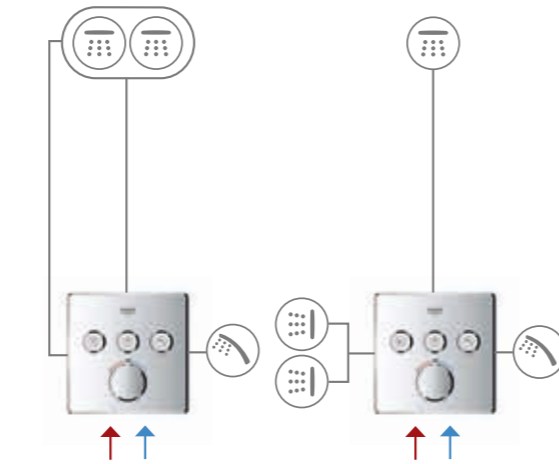

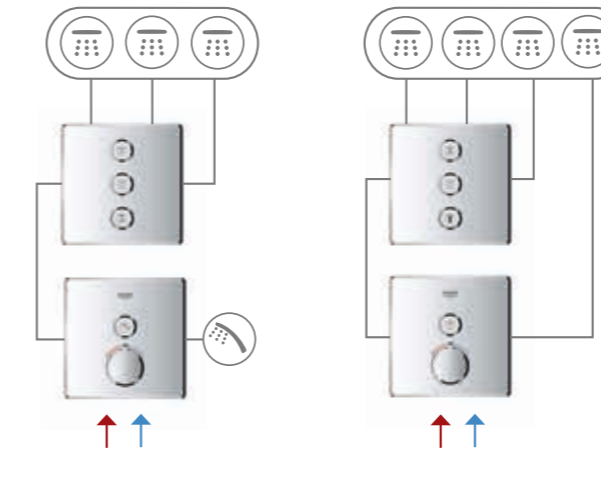
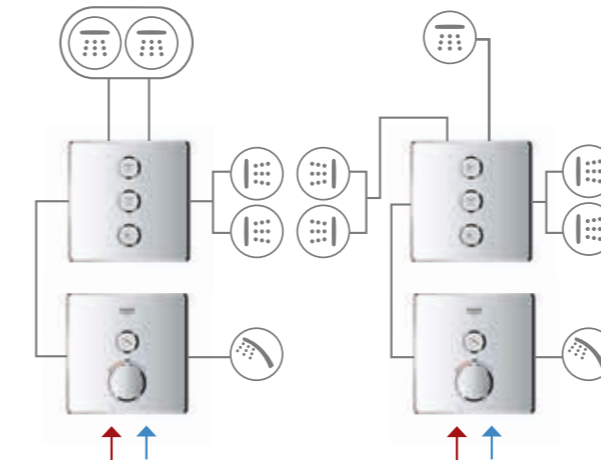

COMBINATION
(THM)



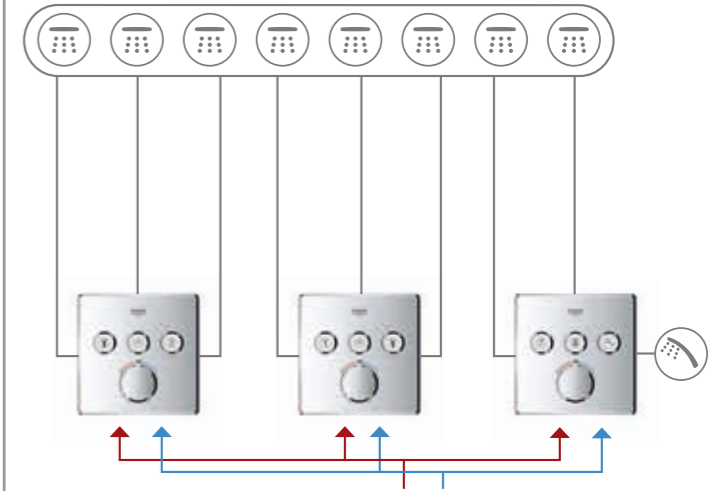

COMBINATION WITH AQUASYMPHONY





TEMPERATURE ZONE 1

- 1. WATERFALL 
- 2. RAIN 
- 3. BOKOMA 

TEMPERATURE ZONE 2

- 1. PURE 
- 2. RAIN 
- 3. WATERFALL 



TEMPERATURE ZONE 3

- 1. DRIZZLE 
- 2. AQUA CURTAIN 
- 3. HANDSHOWER 

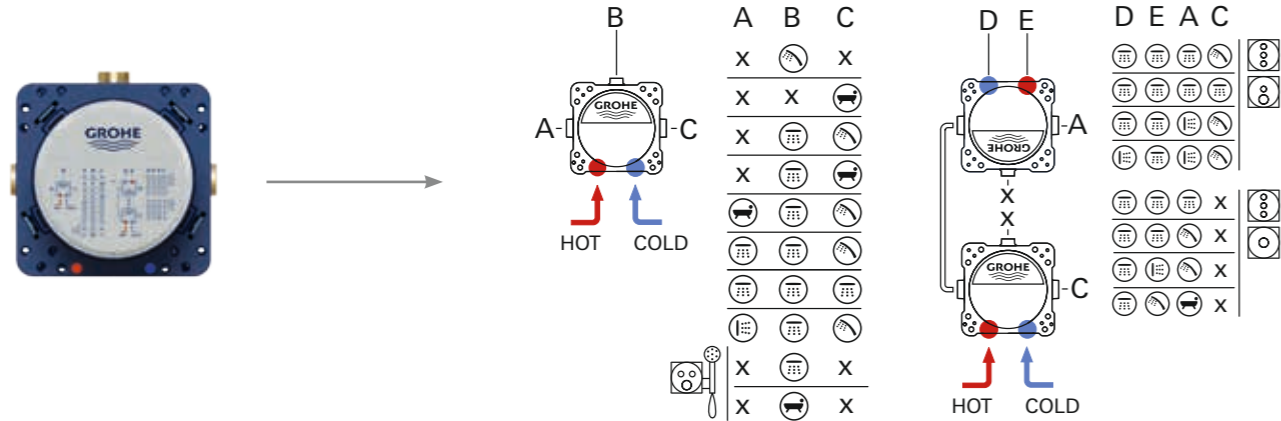
FLOW PERFORMANCE FREE OUTLETS







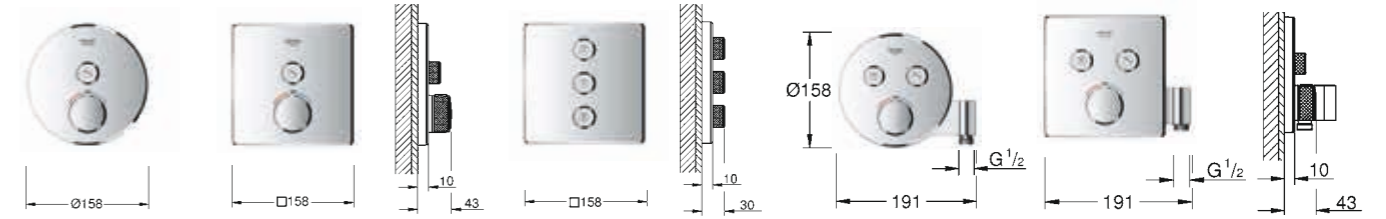

SMARTCONTROL CONCEALED MIXERS

		1 bar	2 bar	3 bar	4 bar	5 bar	6 bar
	outlet B or C	15,6	22,0	27,0	31,2	34,9	38,2
	outlet B	13,3	18,8	23,0	26,6	29,7	32,5
	outlet C	14,4	20,4	25,0	28,9	32,3	35,4
	outlet B+C	15,6	22,0	27,0	31,2	34,9	38,2
	outlet A	12,7	18,0	22,0	25,4	28,4	31,1
	outlet B	15,0	21,2	26,0	30,0	33,6	36,8
	outlet C	12,7	18,0	22,0	25,4	28,4	31,1
	outlet A+B	17,9	25,3	31,0	35,8	40,0	43,8
	outlet A+B+C	19,6	27,8	34,0	39,3	43,9	48,1



SMARTCONTROL CONCEALED THERMOSTATS

		1 bar	2 bar	3 bar	4 bar	5 bar	6 bar
	outlet B or C	16,7	23,7	29,0	33,5	37,4	41,0
	outlet B	13,9	19,6	24,0	27,7	31,0	33,9
	outlet C	15,0	21,2	26,0	30,0	33,6	36,8
	outlet B+C	16,7	23,7	29,0	33,5	37,4	41,0
	outlet A	13,3	18,8	23,0	26,6	29,7	32,5
	outlet B	15,6	22,0	27,0	31,2	34,9	38,2
	outlet C	13,3	18,8	23,0	26,6	29,7	32,5
	outlet A+B	19,1	26,9	33,0	38,1	42,6	46,7
	outlet A+B+C	20,8	29,4	36,0	41,6	46,5	50,9
	outlet D	16,2	22,9	28,0	32,3	36,1	39,6
	outlet E	16,2	22,9	28,0	32,3	36,1	39,6
	outlet A	16,2	22,9	28,0	32,3	36,1	39,6
	outlet D+E+A	37,5	53,1	65,0	75,1	83,9	91,9
	outlet D	12,1	17,1	21,0	24,2	27,1	29,7
	outlet E	12,1	17,1	21,0	24,2	27,1	29,7
	outlet A	12,1	17,1	21,0	24,2	27,1	29,7
	outlet C	16,7	23,7	29,0	33,5	37,4	41,0
	outlet to valve box	19,6	27,8	34,0	39,3	43,9	48,1
	outlet D+E+A	16,7	23,7	29,0	33,5	37,4	41,0
	outlet D+E+A+C	20,8	29,4	36,0	41,6	46,5	50,9
	outlet B	13,9	19,6	24,0	27,7	31,0	33,9
	hand shower	6,9	9,8	12,0	13,9	15,5	17,0

SIMPLY ALL YOU NEED THE COMPLETE RANGE

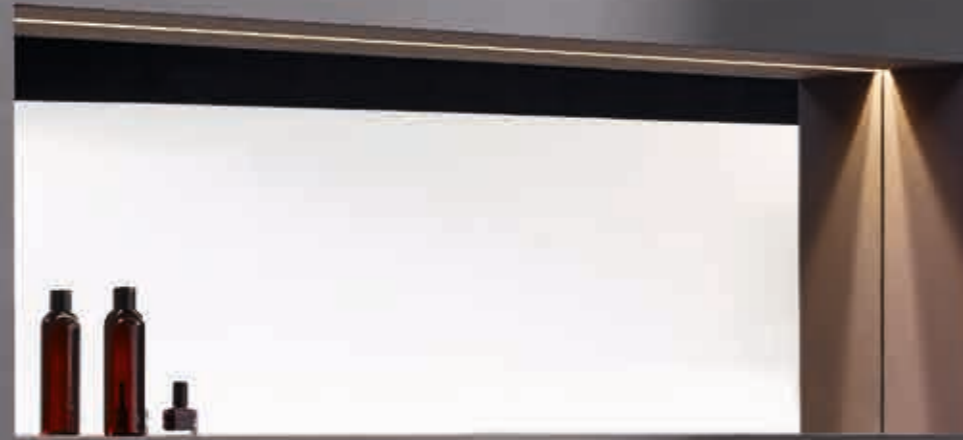

GROHTHERM SMARTCONTROL THERMOSTAT RANGE AT A GLANCE

SMARTCONTROL MIXERS RANGE AT A GLANCE

GROHE RAPIDO SMARTBOX ACCESSORIES

CUBE



29 123 000 Grotherm SmartControl, single
29 124 000 Grotherm SmartControl, double
29 125 000 Grotherm SmartControl, double, integrated handshower union

CUBE ACRYLIC GLASS



29 153 LS0 Grotherm SmartControl, single
29 156 LS0 Grotherm SmartControl, double

MIXER-CUBE



29 147 000 SmartControl Mixer, single
29 148 000 SmartControl Mixer, double



35 600 000 GROHE Rapido SmartBox



29 126 000 Grotherm SmartControl, triple
29 127 000 Grotherm SmartControl, triple valve



29 157 LS0 Grotherm SmartControl, triple
29 158 LS0 Grotherm SmartControl, triple valve



29 149 000 SmartControl Mixer, triple



14 055 000 Backflow protection combination (EN1717)



49 003 000 Reversed GROHE TurboStat Cartridge 3/4"

ROUND



29 118 000 Grotherm SmartControl, single
29 119 000 Grotherm SmartControl, double
29 120 000 Grotherm SmartControl, double, integrated handshower union

ROUND ACRYLIC GLASS



29 150 LS0 Grotherm SmartControl, single
29 151 LS0 Grotherm SmartControl, double

MIXER-ROUND



29 144 000 SmartControl Mixer, single
29 145 000 SmartControl Mixer, double



14 053 00M Service Stops (2 pcs)



14 048 000 Extension Set



29 121 000 Grotherm SmartControl, triple
29 122 000 Grotherm SmartControl, triple valve



29 904 LS0 Grotherm SmartControl, triple
29 152 LS0 Grotherm SmartControl, triple valve



29 146 000 SmartControl Mixer, triple

PURE FREUDE AN WASSER

Life-giving, universal, joyful – water itself is the source of inspiration for the whole of our distinctive product portfolio. Each of these products is always based on our four core values: Quality, Technology,

Design and Sustainability. Balancing these in everything we do, allows us to deliver unrivalled water enjoyment to our customers.

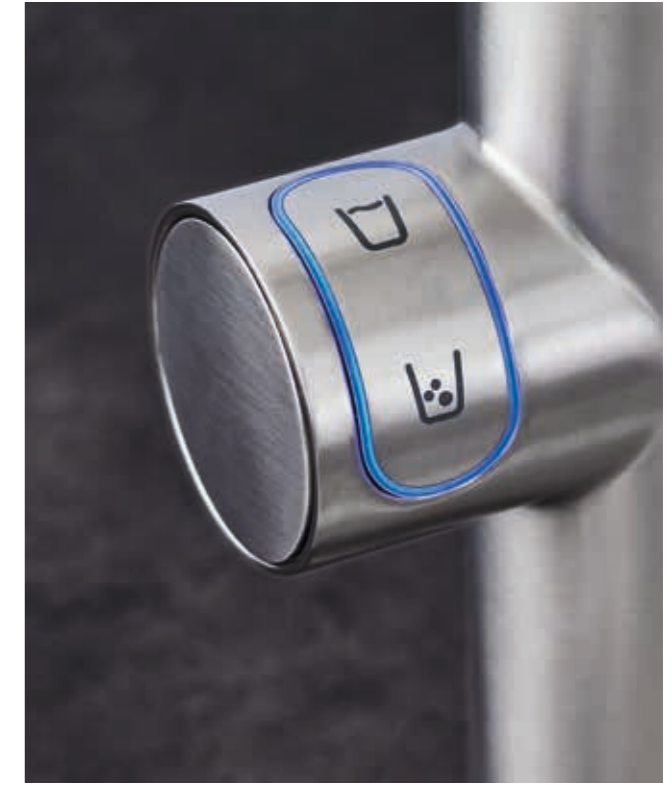

QUALITY

GERMAN PERFECTIONISM INSPIRES ULTIMATE CUSTOMER CONFIDENCE.

We strive for an excellence that goes way beyond the surface of our products. In fact, from design to production and customer service we aim for nothing less than perfection at every stage. Our history of great German engineering, rigorous internal tests and numerous external certification processes are what gives our customers complete confidence in a name they can trust.

TECHNOLOGY

MASTERING WATER THROUGH TECHNOLOGY.

In our relentless search for technological innovation we work to integrate the latest digital advances, creating smart solutions that enhance our customers' enjoyment of water. Our in-house experts harness the power of water to enhance the experience of our customers every day – the moment of truth, for our products and brand.

DESIGN

SIGNATURE ELEMENTS STYLED TO PERFECTION.

An empathetic and intuitive design language offers us the opportunity to create products that feel as if they were designed just for you. This unique GROHE DNA that is both ergonomic and visually distinctive has earned us numerous design awards: world class references are testimony to our world-wide recognition.

SUSTAINABILITY

ENSURING WATER ENJOYMENT FOR GENERATIONS TO COME.

Water is as essential as the air that we breathe, one more reason why we are so passionate about it. To be able to offer "Pure Freude an Wasser", not just to today's consumer but for generations to come, we offer sustainable product solutions like GROHE Blue, GROHE EcoJoy and GROHE SilkMove ES, and we demonstrate through our Sustainability Report and Sustainability accolades that we have made a serious corporate commitment to protecting the planet.



Winner 2017

WELCOME TO GROHE SMART

Be SMART and become a partner of the largest loyalty program for bathroom installers! GROHE SMART is specially designed for installers of GROHE products: As a GROHE SMART partner you get more for your money – more “SMARTS” for every GROHE product purchased from the entire range and a wider choice of exciting rewards.

But it's not just individual installers that can become a partner with GROHE SMART. Your entire business can be involved – every employee can collect points, known as SMARTS, for the company.

WHAT ADVANTAGES DOES GROHE SMART OFFER YOU?

Collect “SMARTS” and get your Rewards

Our range contains more than 2,500 products for in front of and behind the wall installations – and you can collect SMARTS for all of these products and exchange them for attractive rewards! Registering the products you have purchased is easy. Simply enter the UPI code or scan the QR code from the GROHE packaging online or via the SMART app available in the Apple and Android stores – and start collecting your valuable bonus points.

Membership is free and flexible

Your membership of GROHE SMART is completely free of charge and attuned to your particular needs: Receive benefits, rewards and information specifically tailored to your personal requirements. The more you use GROHE SMART, the better we can support you.

Keep up to date

Thanks to GROHE SMART you're always well-informed. Be the first to receive product news, get invited to product courses and introductions in your area, take part in free e-learning modules and know all of the special offers available.

Register now at www.grohesmart.com



DISCOVER THE WORLD OF GROHE

What you see here represents just a small selection of what the world of GROHE has to offer. Whether you are looking for ideas and inspiration or solutions for bath and kitchen, here's where you'll find it.

Just scan the QR codes to view the latest brochures as download or PDF on your tablet or smart phone.

Or visit the world of GROHE at grohe.com

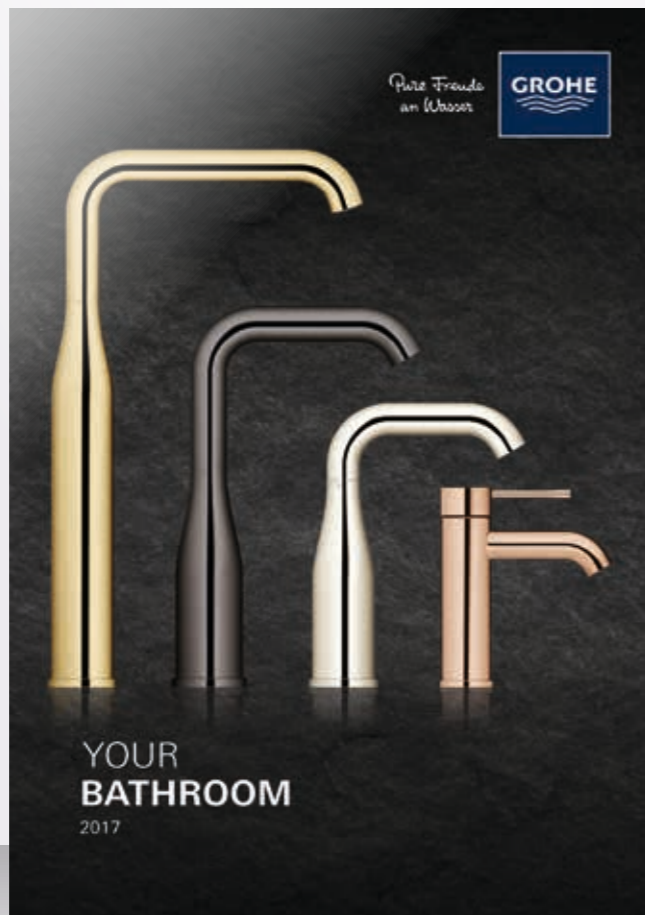

BATH BROCHURE

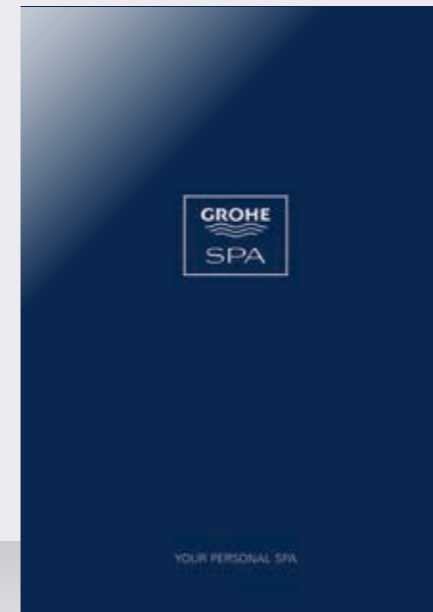

SPA BROCHURE

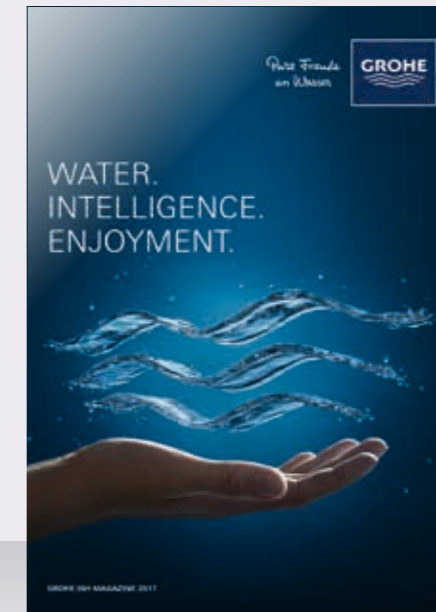

WATER. INTELLIGENCE. ENJOYMENT. MAGAZIN



CERAMICS BROCHURE



SHOWER TOILET BROCHURE



KITCHEN BROCHURE



SANITARY SYSTEMS BROCHURE



A GLOBALLY CONNECTED COMPANY

GROHE IS PART OF LIXIL – A GLOBAL LEADER IN THE HOUSING AND BUILDING INDUSTRY.

Beginning back in early 20th century Japan, LIXIL is today the most comprehensive company in our industry, with a unique portfolio spanning everything from technologies that revolutionize how we interact with water, to a full lineup of interior and exterior materials and products for houses and major architectural projects. Operating in 150 countries, LIXIL companies design and manufacture products that are used by more than a billion people around the world every day.

The world is changing rapidly, and LIXIL companies are helping to shape it. Across our brands and technologies, we design and manufacture tomorrow's living solutions, today. From developing smart innovations in people's homes and offices, to redefining the world's most famous city skylines, LIXIL products are transforming the spaces in which we all work, learn, travel, relax, and live.

Alongside GROHE in LIXIL's family of world-class brands are American Standard, INAX, DXV by American Standard and Permasteelisa. Combined, our brands make us number one in faucets and plumbing-related products worldwide and Japan's premier provider of housing products. We're leading the way in many other areas around the world, thanks to our shared focus on creating innovations that genuinely improve people's lives.

Together we're stronger. Combining our GROHE expertise as a world leader in sanitary fittings with the unique technology and insights from LIXIL's other Water Technology brands, GROHE now offers complete bathroom solutions, featuring innovative products like shower toilets and SmartControl showers, alongside revolutionary technologies such as AquaCeramic sanitaryware that stays clean for 100 years. Beautiful, functional and reliable, LIXIL's products and solutions are changing the way people live, all over the world.

Together, we share a powerful vision of a better tomorrow, for our customers and for the world. As a truly global manufacturing company, we know that we have an important part to play in securing the future of our planet. We're leading the way in areas such as energy efficiency and water saving technology and aim to achieve a net zero environmental footprint by 2030. We believe everyone should have access to clean and safe sanitation, and are committed to using our expertise to help make this possible.

Together we're creating the future of good living for everyone, everywhere.

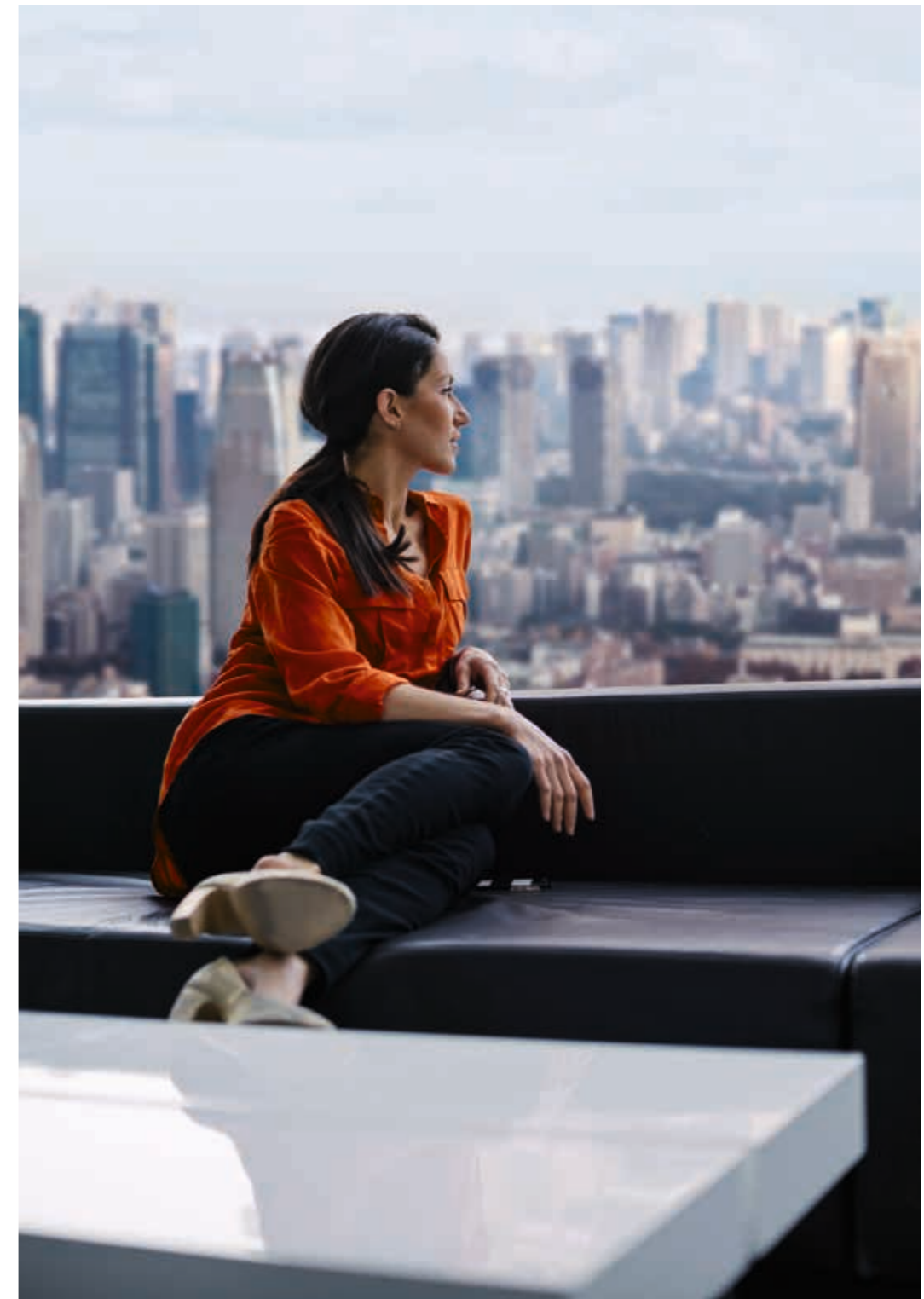

Follow us



Just scan the QR code to view the latest brochure as download or PDF on your tablet or smartphone.

Grohe AG
Feldmühleplatz 15
D - 40545 Düsseldorf
Germany

© 03/2017 – Copyright by GROHE

PART OF **LIXIL**