



redback

## MOWRO RM18



## Operation Manual



This safety alert symbol identifies important safety messages in this manual. Failure to follow this important safety information may result in serious injury. Carefully read and understand the manual completely before attempting to operate the MowRo.



For Service or Questions

**Call 1-800-976-3009**

*[www.mowro.com](http://www.mowro.com)*

# Table of Contents

<b>Important Safety Information</b> .....	4
<b>Warranty Information</b> .....	7
<b>Mower Part and Overview</b> .....	8
<b>Planning and Layout Guide</b> .....	10
<b>Docking Station Installation</b> .....	12
<b>Mower Operations</b> .....	13
<b>Mower Sensors</b> .....	16
<b>Color Customization</b> .....	17
<b>Mower Maintenance and Storage</b> .....	18
<b>Troubleshooting</b> .....	20
<b>Trouble Shooting Information Codes</b> .....	21
<b>Product Specifications</b> .....	23



## Installation Video

<http://rm18installvideo.mowro.com>

# Important Safety Information



WARNING

**WARNING:** Read and thoroughly understand all instructions and safety information before assembling or operating the MowRo Lawn Mower. Failure to do so may cause serious injury. Do not allow anyone to operate this MowRo Lawn Mower who has not read this manual. As with all power equipment, the MowRo can be dangerous if assembled or used improperly. Do not operate this mower if you have doubts or questions concerning safe operation.

Call our customer service department at **1-800-976-3009**, or visit **[www.mowro.com](http://www.mowro.com)** if you have any questions or concerns about the safe operation of this equipment.



DANGER

## Intended Use

The MowRo Lawn Mower has been designed for residential lawn mowing up to 0.15 acre in area. It is not suitable for lawns with grades greater than 20°. Do not use the MowRo for any purpose other than for which it was designed. Any other use is unauthorized and may result in serious injury.

## Personal Protective Equipment

Always remove the security key before lifting, moving or transporting the MowRo. When handling the MowRo Lawn Mower it is important to avoid the blades that are two sided and double edged and therefore extremely sharp. It is recommended to wear safety gloves to make adjustments to the MowRo or when changing the blades or blade disc.



# Important Safety Information

## General Safety

Failure to follow warnings, cautions, assembly and operation instructions in the Operation Manual may result in serious injury.



DANGER

### READ THE OPERATION MANUAL BEFORE OPERATION.

- **Do not** permit children to operate this equipment at any time.
- **Do not** permit others that have not read and understood the complete Operation Manual to operate this equipment.
- Keep all people and pets a minimum of 10 feet away from the work area.
- Do not operate the MowRo in rain or other wet conditions.
- Use caution when handling the MowRo. Blades are extremely sharp.

## Docking Station

- Use only the docking station designed for the MowRo.
- Do not attempt to modify the Robot Mower or the docking station in any way other than specified by the manufacturer.
- When battery replacement is required, replace only with an original or manufacturer authorized replacement.
- **DO NOT** dispose of the MowRo in household waste.
- **DO NOT** dispose of the battery in household waste.
- Ensure correct installation of the boundary wire.
- Make a regular inspection of the MowRo's working area and remove stones, branches, toys and other objects that may cause damage to the robot.
- Never place anything on top of the MowRo or the docking station.
- Check the blades for wear and replace when necessary.
- Check that bolts, screws and nuts are securely fastened to ensure the optimum operation of the MowRo.
- Avoid running the MowRo in wet grass. Clean the MowRo's wheels and wheel holder carefully of earth, grass and dust to avoid imbalance.



# Important Safety Information

## Safety Icons

Safety icons are to remind you of important information while you are operating the unit.



Use caution when operating this power equipment.



Read and understand the Operation Manual before operating the MowRo Lawn Mower.



The MowRo has sharp blades. Use caution when operating, transporting and handling.



The MowRo may throw objects. Keep children, pets and bystanders away from mower when operating.



The MowRo has sharp blades. Use caution when operating around other people and pets.



Keep your hands and feet away from the rotating blades. Use extreme caution when lifting and transporting. Wear gloves to handle the blades or blade disc.



Avoid operating in the rain, protect the battery and docking station from wet conditions.

## Safety Decals

Safety decals on the MowRo are to remind you of important information while you are operating the unit. Make sure all decals are attached and in readable condition. Replace missing or defaced decals. Contact us at 1-800-976-3009 or go to [www.mowro.com](http://www.mowro.com) for replacement decals.



# Warranty

## IMPORTANT NOTICE

Redback warranties this product, to the original purchaser with proof of purchase, for a period of two (2) years against defects in materials, parts or workmanship. Redback, at its own discretion, will repair or replace any and all parts found to be defective, through normal use. This warranty is valid for only units that have been used for personal use, and that has been maintained in accordance with the instructions in the owner's manual.

The battery carries a one (1) year limited warranty, including warranty against defects in workmanship and materials. Batteries must be charged in accordance with the owner's manual directions and regulations in order to be valid.

Transportation charges for the movement of any unit are the responsibility of the purchaser. It is the purchaser's responsibility to pay transportation charges for any product submitted for replacement under this warranty, unless such return is requested in writing by Redback.

This warranty is null and void in the event of the installation of unauthorized spare parts.

Items not covered by warranty:

1. Any part that has become inoperative due to misuse, commercial use, abuse, neglect, accident, improper maintenance, or alteration; or
2. The unit, if it has not been operated and/or maintained in accordance with the owner's manual; or
3. Normal wear, except as noted below;
4. Routine maintenance items such as lubricants, unauthorized blades;
5. Normal deterioration of the exterior finish due to use or exposure.

MowRo Helpline:

Contact Us: 1-800-976-3009 [www.mowro.com](http://www.mowro.com)

# Overview

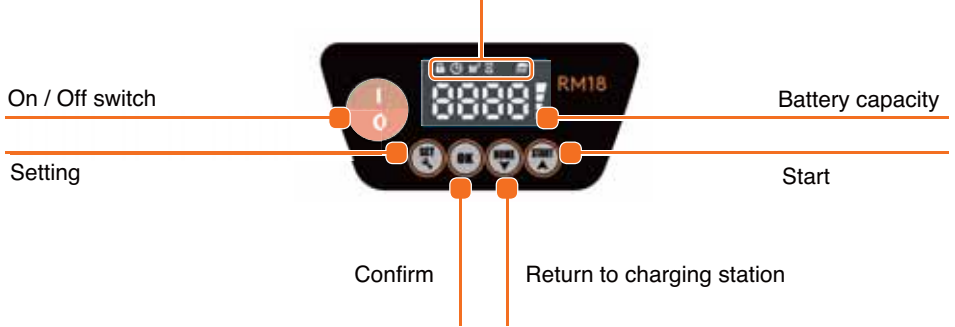



6 pegs for the charging station

150 boundary line pegs

9 spare blades with screws

Power Supply Transformer



100m boundary line

2 Wire Clamps

4 Wire Splicers

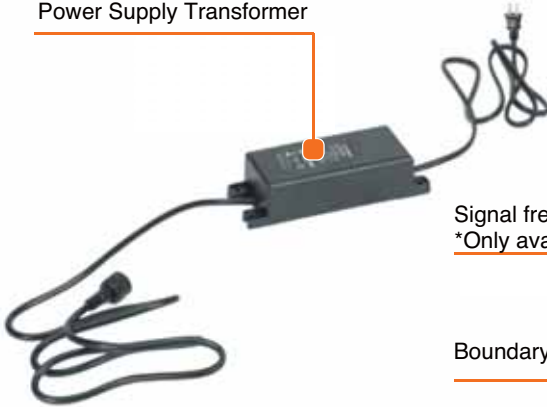

LED  
Green blinking,  
charging.  
Green firmly,  
stand-by

Boundary line  
disconnected

Signal frequency  
\*Only available on APP version

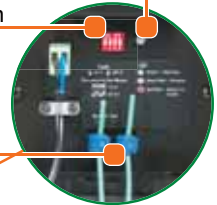

Boundary line connector

Connection to PSU

Charging station

Charging electrode

Extension cable

# Planning and Laying the Boundary Line

## Laying Boundary Lines

In order to make the Robot Mower mow within the desired area – and only that area – you need to mark the area by means of boundary wiring. Remove all foreign objects, rocks, roots, etc. that may interfere with the Robot Mower's operation in the mowing area. Large objects such as trees, swings sets, ponds, etc. should be encircled by the boundary line. The boundary wire line needs to be laid out in a continuous line (see Figure 2 on following page).

Route the boundary line around objects using a minimum of 100° angles (135° angles are recommended). Keep the boundary line at least 35cm (14") away from any: walls, drop-offs, or uneven edge. If the lawn is level with the edge of the grass set the wire 10cm (4") away from the edge. Do not allow the boundary wire to cross itself.

The boundary line should be placed at the root level of the grass (see Figure 1). Secure the boundary line into the ground and anchor with the boundary stakes. Place a stake approximately every 3 feet.

NOTE: The Robot Mower will find it difficult to work on grades greater than 20°. On slopes steeper than 20° the robot's sensor will shut the mower off.

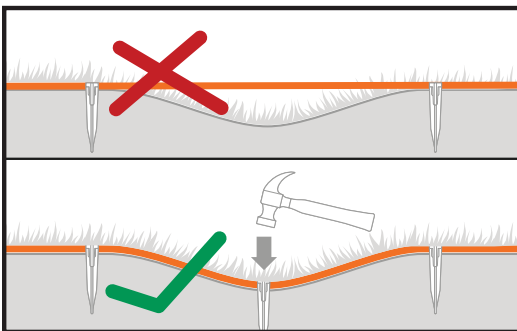

Figure 1

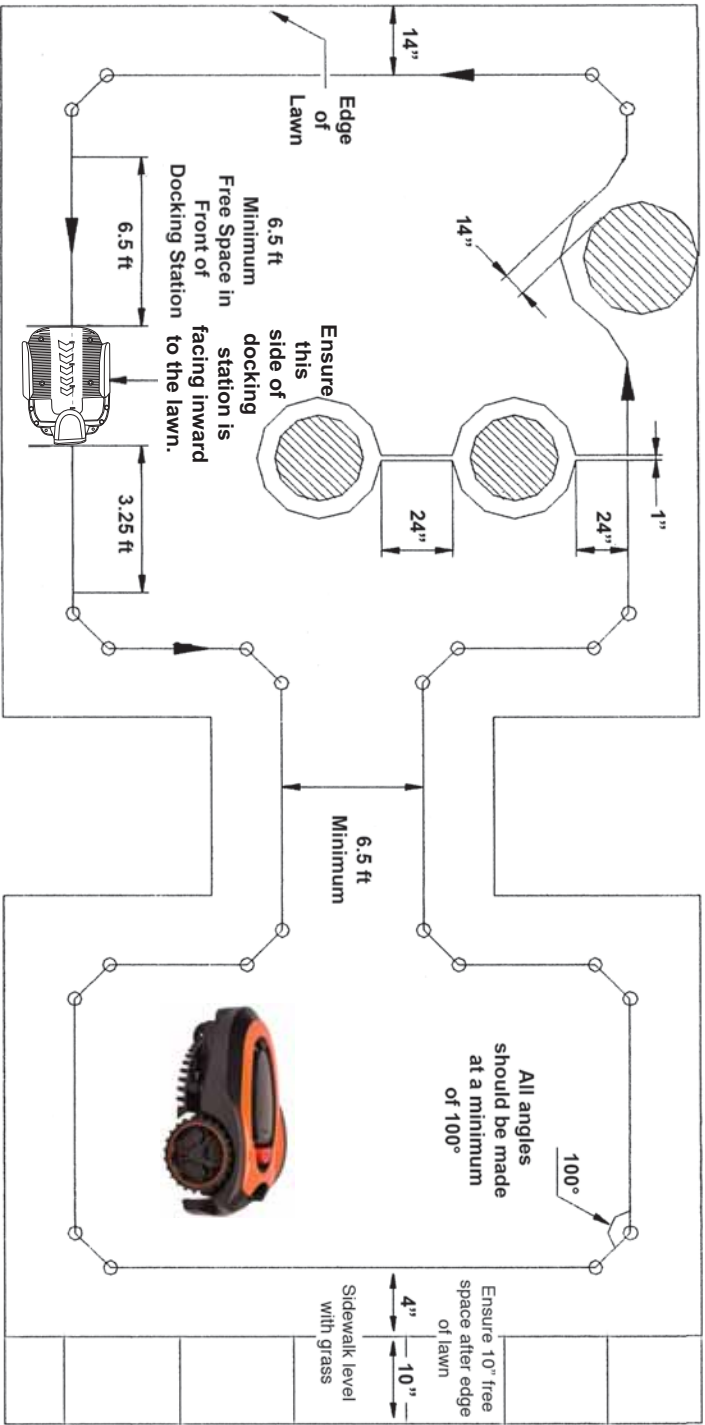

Figure 2

# Docking Station Installation

The docking station must be placed on a solid, flat surface. Avoid placing the docking station in a corner of the lawn or in low-lying areas where the docking station or the Robot Mower may be damaged by puddles, or under a high tree due to the risk of lightning.

**Note: It is important that the adapter and the electrical plug are always kept dry!**

The docking station must have 6.5 feet of free space in front of it so the Robot Mower can return to charge or when mowing is complete (see Figure 3). The docking station must be located on level ground for correct operation.

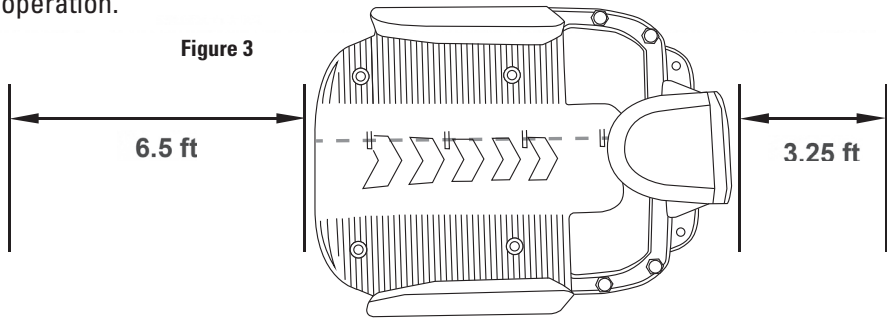

## Connecting the Boundary Line to the Docking Station

Remove the terminal cover located on the back of the docking station. Insert the end of the boundary wire into a blue T-clip and use a pair of pliers to press the clip on the wire until you hear a click. Repeat this action on the other end of the wire. Insert the wire that leaves the docking station into the negative (-) metal prong. Connect the wire that comes from under the docking station to the positive (+) metal prong. Proceed to plug in the docking station and confirm the LED is a solid GREEN light. If the LED is flashing RED and GREEN confirm all of your docking station connections are securely inserted and the boundary wire does not have any cuts or breakage.

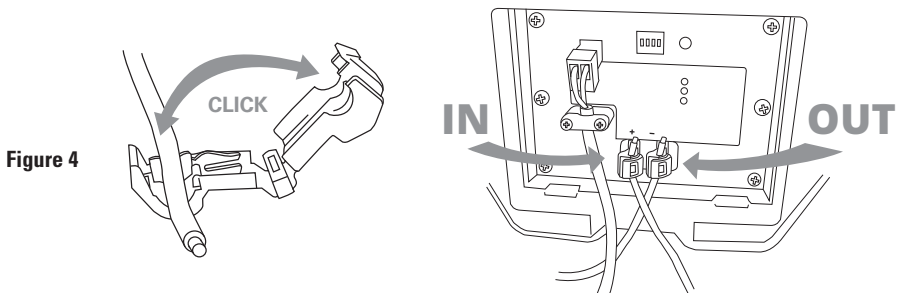

# Operation



## Mower Operation

Note: To ensure proper setup, verify that the mower is fully charged and is in contact with the docking station.

Note: Make sure that the path of perimeter is completely clear before operating.

## Unlocking the Mower

- 1) Turn on the mower by switching the red button (located to the left of the LCD screen)
- 2) The LCD screen will show "Idle".
- 3) Press the "Set" button one time.
- 4) Four zeros and battery life symbol will show on the LCD screen. (This is the PIN code)
- 5) The first zero will be blinking.
- 6) Press the "OK" button four times to unlock the mower. (The factory default code is: 0000)
- 7) The mower is now unlocked, and the user may change the settings of the mower.

## Manual Start

- 1) Unlock the mower. (If locked, see steps 1-7 in the Unlocking the Mower section.)
- 2) Press the "Start" Button and the mower will immediately start to mow.

## Settings Guide and Automatic Start

- 1) Unlock the mower. (If locked, see steps 1-7 in the Unlocking the Mower section.)
- 2) Once the mower is unlocked press the “Set” button to shift through the icons at the top of the screen.

### Setting Your Security PIN



- 1) Unlock the mower. (If locked, see steps 1-7 in the Unlocking the Mower section.)
- 2) Press the “Set” button until the lock icon is showing on the top the LCD screen.
- 3) Upon reaching the lock icon, your screen will display four zeros, with the first zero blinking.
- 4) From this screen, you can switch between the zeros by pressing the “OK” button.
- 5) To set your PIN, shift to the desired zero and use the up and down arrows located on the “Home” and “Start” button to set the number.
- 6) Repeat steps four and five for all remaining numbers.
- 7) Once you have entered your desired PIN, press the “OK” button to toggle through all the numbers until none of them are blinking.
- 8) Press “Set” to save your PIN.

### Setting the Clock



Note: For the mower to properly operate on a schedule, you will need to set the time on the mower’s clock.

Note: THE CLOCK IS FORMATTED IN MILITARY TIME.

- 1) Unlock the mower. (If locked, see steps 1-7 in the Unlocking the Mower section.)
- 2) Press the “Set” button until the clock icon is showing at the top of the LCD screen.
- 3) Upon reaching the clock icon, your screen will display four zeros, with the first zero blinking.
- 4) From this screen, you can switch between the zeros by pressing the “OK” button.
- 5) To set the time, shift to the desired zero and use the up and down arrows located on the “Home” and “Start” button to set the number.
- 6) When complete, toggle to the end of all the numbers until none of them are blinking.
- 7) Press “Set” to save the time.

## Setting the Mow Area



Note: Roughly measure the size of your lawn to determine its area.

- 1) Unlock the mower. (If locked, see steps 1-7 in the Unlocking the Mower section.)
- 2) Press the "Set" button until the meters squared icon is showing at the top of the LCD screen.
- 3) Use the up and down arrows located on the "Home" and "Start" to increase or decrease the mowing area.
- 4) Press the "Set" button to save your mowing area.

## Setting the Start Time



Note: The start time function will not work unless the clock time is set correctly on the mower. (See "Setting the Clock" Section)

Note: THE CLOCK IS FORMATTED TO MILITARY TIME.

- 1) Unlock the mower. (If locked, see steps 1-7 in the Unlocking the Mower section.)
- 2) Press the "Set" button until the hourglass icon is showing at the top of the LCD screen.
- 3) Upon reaching the hourglass icon, the first number in the sequence will be blinking.
- 4) Press the up and down arrows located on the "Home" and "Start" buttons to change the number.
- 5) Press the "OK" to shift to the next number in the sequence, and set the time you want the mower to start.
- 6) Once time is set, press the "OK" button until none of the numbers in the sequence are blinking, then press the "Start Button".
- 7) The mower will begin mowing the area of your lawn.

Note: The mower will begin its first session immediately, once the "Start" button is pressed manually. Scheduled mowing set by the user will begin 48 hours after the initial manual session has completed.

## Obstacle/Contact Sensor

When the Robot Mower meets an obstacle, it will reverse and change direction to avoid the obstacle. If it does not find a new path within 3 seconds, the cutting motor stops. If it does not find a new path within 10 seconds, the robot will shut down and it will require a manual restart.

## Rain Sensor

In case of heavy rain, the Robot Mower will automatically return to the docking station. It will automatically start mowing the next day at the time originally scheduled. NOTE: The rain icon will only display on the LCD screen if the rain sensor on the mower is wet. When the rain sensor is engaged, the mower will immediately find the boundary wire and return to the docking station. Once the sensor is dry, the mower will begin operation again.

## Lift Sensor

This sensor is placed close to the wheels and measures the gravity of the wheels. If the Robot Mower is lifted manually or if both wheels run into a hole, the robot will shut down and must be restarted manually.

## Tilt Sensor

A 6-axle sensor is integrated in the Robot Mower to measure the tilt angle in all directions. If the tilt angle exceeds  $20^\circ$ , the cutting motor will stop immediately but continue driving (see Figure 7). If the angle decreases to less than  $20^\circ$  within 10 seconds, the cutting motor will restart automatically. If, however, the angle does not decrease within 10 seconds the mower will shut down and will require a manual restart.

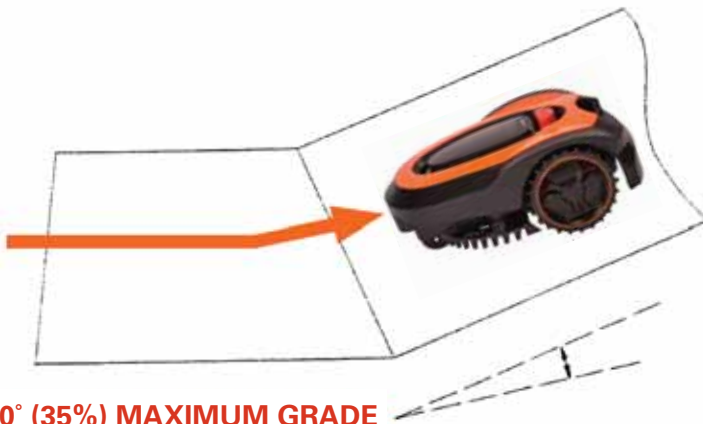

MowRo Model  
Grade Capabilities

RM18 -  $20^\circ$  (35%)

RM24 -  $30^\circ$  (50%)



# CUSTOMIZE FOR YOUR STYLE

WITH OPTIONAL DECORATIVE COLORED HOUSING

**ORANGE**



**RED**



**BLACK**



**PINK**



**BLUE**



**WHITE**



**GREEN**



**GRAY**



**TO BUY CUSTOM COLORS GOT TO**

**[WWW.MOWRO.COM](http://WWW.MOWRO.COM)**

*Installation instructions - <http://rm18colorswap.mowro.com>*

**PART#20740220-COLOR**

# Maintenance and Storage

## Cleaning the Robot Mower

Lift the front and rear covers and remove any collected debris, grass clippings and dust using a soft brush, vacuum or damp cloth. Repeat for the bottom side of the robot using care when handling the blade disc and blades. It is important to keep the blades free from accumulated grass clippings to ensure proper operation of the robot mower. Ensure all retaining screws are secure.

Clean and brush the contacts on the robot mower and the docking station charging arms with steel wool or emery paper.

## Cleaning the Docking Station

Remove dirt, grass and other debris from the docking station base plate on a regular basis.

## Blade Replacement

The Robot Mower blades are accessible when you turn the mower upside down (see Figure 8). Blades have two edges and two sides. The blades can be turned over one time before replacing. Blade replacement is indicated when grass shows prominent white edges after cutting or the mower makes excessive vibration noise. Turn all three blades over or replace all three blades by unscrewing the three retaining screws.

Figure 8

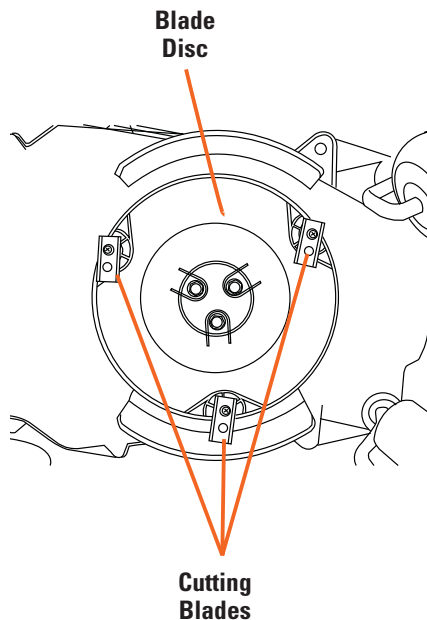



**DANGER**

**Blades are extremely sharp and will cut even when dull.  
Use caution when replacing.  
Wear gloves to protect hands from cuts.**

## **Storage**

Disconnect the docking station from the AC power adapter. Remove the ends of the boundary wire from the docking station. Turn the power switch off on the Robot Mower to protect the battery. Store the Robot Mower, docking station and AC adapter and cords in a dry frost free area. Cover the ends of the boundary wire with electrical tape. To help preserve the life of the battery, check the charge status of the battery and recharge the battery in the docking station at regular intervals.

## **Winter Storage**

During winter seasons, please follow all guidelines explained in the Storage Section above. Failure to properly care for your MowRo will void any remaining warranty.

# Troubleshooting

## Testing the Docking Station

Symptom	Cause	Action
Robot doesn't leave docking station. <i>NOTE: Forgot PIN? Contact customer service</i>	PIN not entered correctly.	Enter factory default PIN (0000) or PIN set by user.
	Battery is not charged.	Allow robot to charge until battery symbol has 4 bars on LCD screen.
	Docking station not installed correctly.	IN arrow on docking station should point to inside of working area.
	Boundary wire not installed correctly.	Wire end routed under docking station should be connected to the positive (+) metal prong.
Robot's initial tracking is incorrect.	Boundary wire not installed correctly.	Adjust boundary wire so robot follows desired path.
	Interference from underground power source.	Reroute boundary wire around obstacle source.
Robot does not reconnect to charging blades on return to docking station.	Docking station is not level.	Reinstall docking station on flat level surface.

## Normal Robot Mower Use

Symptom	Cause	Action
Excessive vibration and noise.	Cutting system unbalanced; blades are dull.	Turn power off and reverse or replace all three blades.
	Blade disc is damaged.	Replace blade disc.
	Disc retaining screws loose.	Tighten screws securely.
Working time between charges decreases.	Charging contacts are dirty.	Clean charging contacts on the robot and the docking station. Brush lightly with steel wool.
	Battery capacity diminished.	Replace battery.
Robot does not leave docking station after rain sensor is activated.	Rain sensor is still activated.	Dry and clean metal contacts. Then restart robot mower.

## First Robot Mower Use

Symptom	Cause	Action
Robot leaves boundary area or stops beyond boundary line.	Wheels are obstructed.	Remove debris from mowing area and/or clean robot's wheels.
	Grass is wet and/or slope is too close to boundary edge.	Reroute boundary wire to avoid slope. Do not operate in wet conditions.

# Information Codes

**Information Codes:** Displayed on LCD Screen

NOTE: How to Manually Restart - Place the machine within 1m near the boundary line, enter correct PIN code, then press "start".

Status Code	Cause	Solution
E1	STOP Button has been engaged.	Manually restart the mower.
E2	Lift sensor has been triggered.	Robot mower lifted? Wheel blocked? Remove foreign objects then manually restart the mower.
E3	Robot mower is out of the boundary line perimeter.	Relocate the robot mower in the boundary line perimeter then manually restart.
E4	No boundary line signal.	Check the status of the LED on the charging station. If it is blinking red, the boundary line is cut or the boundary wire is not properly connected to the docking station. Check boundary wire connection.
E5	A collision sensor is triggered.	Remove any obstacles or relocate the robot mower. Then manually restart the mower.
E6	Overcurrent on left propulsion motor.	Grass too tall and thick? Wheel blocked? If grass is > 2.6" tall cut with traditional mower. If grass is < 2.6" adjust height on mower to make sure the cutting can move without restriction.
E7	Overcurrent on right propulsion motor.	Grass too tall and thick? Wheel blocked? If grass is > 2.6" tall cut with traditional mower. If grass is < 2.6" adjust height on mower to make sure the cutting can move without restriction.
E8	Overcurrent on cutting motor.	Grass too tall and thick? Wheel blocked? If grass is > 2.6" tall cut with traditional mower. If grass is < 2.6" adjust height on mower to make sure the cutting can move without restriction.
E9	Faulty battery.	Battery malfunction, contact customer service.
E10	Under voltage of battery detected.	Place the robot mower back to the charging station and manually restart the mower. If the issue persists, please contact customer service.
E11	Tilt sensor triggered.	Tilting angle > 20°? Robot mower is overturned? Place the robot mower on flat ground and manually restart mower. All wheels must be on the ground to return to operation.
E12	Wheel spinning without grip.	Robot mower stuck in sand or holes? Check the surrounding lawn, place the robot mower on flat ground and manually restart the mower.

# Information Codes

**Information Codes:** Displayed on LCD Screen

NOTE: How to Manually Restart - Place the machine within 1m near the boundary line, enter correct PIN code, then press "start".

E13	Battery overheat.	If this issue persists, please contact customer service.
F1	Robot is out of boundary line perimeter.	Robot mower is outside boundary wire? Boundary line is connected reversely? Robot mower is too far from the boundary line? Check boundary line connections, place mower inside wire perimeter, manually restart mower.
F2	Won't start after pressing "start" button, boundary line signal not available.	Check the status of the LED on the charging station. If it is blinking red, boundary line is cut or the boundary wire is not properly connected to docking station. Check boundary wire connection.
F3	Won't start after pressing "start" button, bad charging contact.	Clean the charging contacts and remove any foreign objects. Place mower back in docking station and allow it to charge fully. Manually start mower while in the docking station.
F4	Won't start after pressing "start" button, battery voltage is too low.	Return the robot mower to the charging dock and let it fully recharge.

# Specifications

## IMPORTANT NOTICE

We, the manufacturer, reserve the right to change the product and/or specifications in this manual without notification. The manual is for information usage only and the pictures and drawings depicted herein are for reference only.

## Warranty Repair and Service

Do not return this product to the store for warranty issues or repair. Call our customer service department at **1-800-976-3009** or visit **[www.mowro.com](http://www.mowro.com)** for the location of the nearest service center.

**Record the information below for future reference.**

**Serial No.** \_\_\_\_\_

**Date of Purchase** \_\_\_\_\_

**Place of Purchase** \_\_\_\_\_

SKU/Part No.	RM18
Lithium Battery Voltage	28V
Lithium Battery Capacity	4Ah
Motor Type	Brushless
Blade Speed	2900 rpm
Cutter Type	3 Blades
Cutting Width	180mm (7")
Cutting Height	20 – 60mm (.8 – 2.4")
Mowing Areas	600m <sup>2</sup> (0.15 acre)
Maximum Climb Angle	20°
Maximum Walking Speed	0.5m/s (1.64ft/sec)
Boundary Wire Length	100m (330ft)
Warranty	2 Years Limited/1 Year Limited on Battery



**redback**

**Call 1-800-976-3009**

[www.mowro.com](http://www.mowro.com)



**Installation  
Video**

<http://rm18installvideo.mowro.com>