

CODE NUMBER

3451103

DESCRIPTION

1.6 gpf, Rough Brass Finish, Fixture Connection Rear Spud, Single Flush, 2-10.75 L Dimension, Electrical Override, Hardwired, Sensor-Operated, With Wall Box, Royal® Concealed Sensor Hardwired Water Closet Flushometer.

DETAILS

- Flush Volume: 1.6 gpf (6.0 Lpf)
- Finish: Rough Brass (RB)
- Power Type: Hardwired (HW)
- Valve: Diaphragm
- Valve Body Material: Semi-red Brass
- Fixture Type: Water Closet
- Fixture Connection: Rear Spud
- Rough-In Dimension: 14 ½" (368mm)
- Spud Coupling: 1 ½" (38mm)
- Supply Pipe: 1" (25mm)
- L Dimension: 2"-10 ¾" (51-273mm) (2-10-3/4-LDIM)
- Override: Electrical (OR)
- Wall Box: With (W/BOX)

FEATURES

- PERMEX® Synthetic Rubber Diaphragm with Dual Filtered Fixed Bypass
- 1" I.P.S. Wheel Handle Bak-Chek® Angle Stop
- User friendly three (3) second Flush Delay
- OPTIMA® EL-1500 Self-Adaptive Infrared Sensor with Indicator Light
- Adjustable Tailpiece
- Non-Hold-Open Integral Solenoid Operator, Fixed Metering Bypass and No External Volume Adjustment to Ensure Water Conservation
- Courtesy Flush® Override Button
- Diaphragm, Stop Seat and Vacuum Breaker to be molded from PERMEX® rubber compound for Chloramine resistance

VIDEOS

- ▶ [ESS Flushometer](#)

**COMPLIANCES & CERTIFICATIONS**

(ADA Compliant, cUPC Certified, BAA Compliant, UL Certified)

RECOMMENDED SPECIFICATION

Valve Body, Cover, Tailpiece and Control Stop shall be in conformance with ASTM Alloy Classification for Semi- Red Brass. Valve shall be in compliance with the applicable sections of ASSE 1037 and ANSI/ASME 112.19.2.

ELECTRICAL SPECIFICATIONS

- Arming Delay: 16 seconds
- Control Circuit: 24 VAC Input/24 VAC Output/Solid State
- Flush Delay: 3s
- Self-Adaptive Window: ±10
- Sensor Range: 22"-42" (559-1,067mm)
- Solenoid Operator: 24 VAC
- Transformers:
 - 0345154
 - 0345999

VALVE OPERATING PRESSURE (FLOWING)

15-80 PSI (103-552 kPa). Specific fixtures may require greater minimum flowing pressure - consult manufacturer requirements.

DOWNLOADS

- [Optima Sensor Activated Royal Installation Instructions](#)
- [Royal 140/152/153/195 ESS TMO SWB Installation Instructions](#)
- [Royal 152/195 ESS TMO Installation Instructions](#)
- [Control Stop Repair and Maintenance Guide](#)
- [Flush Connections Flanges Repair and Maintenance Guide](#)
- [Tail Piece Repair and Maintenance Guide](#)
- [Optima ESS Repair and Maintenance Guide](#)
- [Optima TMO Repair and Maintenance Guide](#)
- [Additional Downloads](#)

Sloan 10500 Seymour Ave, Franklin Park, IL 60131

Phone: 800.982.5839 • Fax: 800.447.8329 • sloan.com

NOTES

All information contained within this document subject to change without notice.

Looking for other variations of the ROYAL 140 ESS product?
[View the general spec sheet with all options.](#)

[Find a compatible urinal](#) for this flushometer.

[Find a compatible water closet](#) for this flushometer.

ROUGH-IN

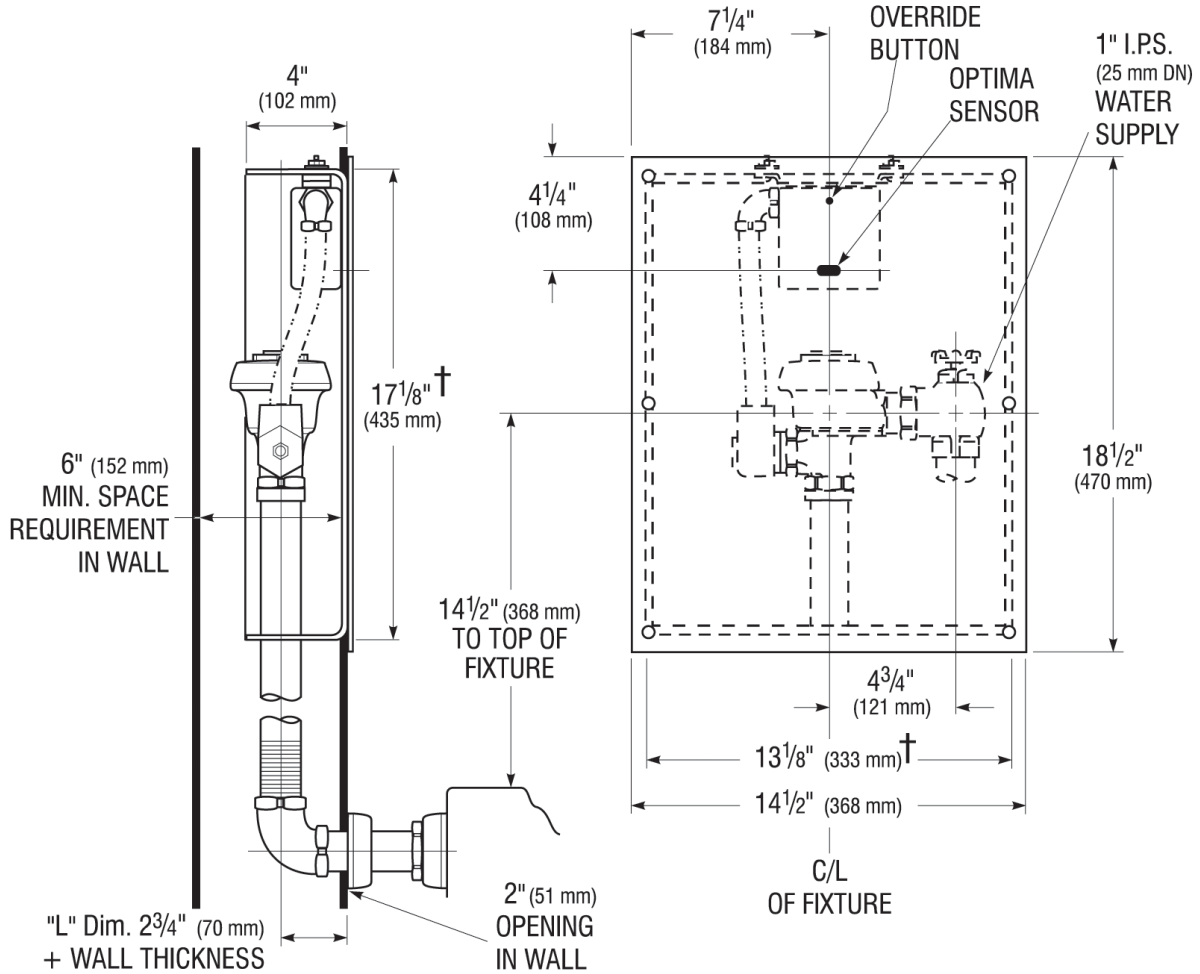

Sloan 10500 Seymour Ave, Franklin Park, IL 60131

Phone: 800.982.5839 • Fax: 800.447.8329 • sloan.com