









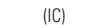

Cables and Flexible Leaders

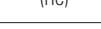
- Inner Core (IC) cables provide good flexibility and more cleaning power to the cable end.
- Integral Wound (IW) cables are wound tighter on the inner core creating a solid assembly.







| | Catalog No. | Model No. | Description | Weight | |
|-------------|---|-----------|--------------------------|--------|------|
| | | | | lb. | kg |
| 5/8" - 16mm |  92460 | C-25 | 25' IC Cable (7.6m) | 24 | 10.9 |
| |  92465 | C-26 | 50' IC Cable (15.2m) | 43 | 19.5 |
| |  92470 | C-27 | 75' IC Cable (22.9m) | 63 | 28.6 |
| |  43647 | C-24 | 100' IC Cable (30.5m) | 84 | 38.1 |
| |  32737 | C-27HC | 75' Hollow Core (22.9m) | 52¾ | 23.9 |
| |  58192 | C-24HC | 100' Hollow Core (30.5m) | 70½ | 32.0 |
| |  95762 | C-25 IW | 25' IW Cable (7.6m) | 24 | 10.9 |
| |  95757 | C-26 IW | 50' IW Cable (15.2m) | 43 | 19.5 |
| |  95752 | C-21 IW | 75' IW Cable (22.9m) | 63 | 28.6 |
| |  95747 | C-24 IW | 100' IW Cable (30.5m) | 84 | 38.1 |
| |  92555 | T-458 | 5/8" x 2' Leader | 2 | 0.85 |
| |  44122 | — | 5/8" Pigtail | 2½ | 1.13 |



Standard equipment included in all machine options

Tools and Replacement Blades – Fits 5/8" IC and IW Cables

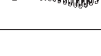
C-24, C-25, C-26, C-27, C-24IW, C-25IW, C-26 IW, C-27 IW, C-24HC, C-27HC

| | Catalog No. | Model No. | Description | Replacement | |
|---|-------------|-----------|--------------------|-------------|--------|
| | | | | Blade(s) | Holder |
|  | 92485 | T-403 | P-Trap Cutter, 3" | 92835 | 92900 |
| | 92490 | T-404 | P-Trap Cutter, 3½" | 92840 | 92900 |
|  | 92495 | T-406 | Spear Blade | 92850 | 92915 |
|  | 92500 | T-407 | Retrieving Auger | — | — |
|  | 92505 | T-408 | Sawtooth Cutter | 92890 | 92915 |
|  | 51762 | T-409 | H-D Bulb Auger | — | — |
|  | 92510 | T-411 | Double Cutter, 2" | 92815 | 92905 |
| | 92515 | T-412 | Double Cutter, 2½" | 92820 | 92905 |
| | 92520 | T-413 | Double Cutter, 3" | 92825 | 92910 |
| | 92525 | T-414 | Double Cutter, 4" | 92830 | 92910 |
| | 92530 | T-416 | Double Cutter, 6" | 92855 | 92910 |
|  | 92535 | T-432 | 3-Blade Cutter, 2" | 92860 | 92895 |
| | 92540 | T-433 | 3-Blade Cutter, 3" | 92865 | 92895 |
| | 92545 | T-434 | 3-Blade Cutter, 4" | 92870 | 92895 |
| | 92550 | T-436 | 3-Blade Cutter, 6" | 92875 | 92895 |

Optional Accessories

| Catalog No. | Description |
|-------------|-----------------------------------|
| 95812 | AUTOFEED – K-6200 |
| 49032 | Front Guide Hose Assembly, 3 feet |
| 95797 | Lifting Hook – K-6200 |
| 95792 | Swivel Loading Wheel Assembly |
| 95802 | K-6200 Drum Assy. w/5/8" Pigtail |
| 95807 | K-3800 Drum Assy. w/6200 Adapters |
| 95822 | K-3800 to K-6200 Adapter Kit Only |
| 59987 | Cable Rust Inhibitor 1 Gal. |
| 91047 | Female Repair Coupling |
| 70032 | RIDGID PVC Drain Cleaning Gloves |

Standard Accessories

- T-411 2" Double Cutter
- T-413 3" Double Cutter
- T-414 4" Double Cutter
- T-406 Spear Blade
- Pair Reclining Legs
- RIDGID Drain Cleaning Gloves
- T-458 5/8" x 2' Trap Leader (Not Shown)

Inner Core (IC) Cables



Good flexibility and more cleaning power to the cable end.

| | Catalog No. | Model No. | Description | Weight | |
|-------------|-------------|-----------|-----------------------|--------|------|
| | | | | lb. | kg |
| 5/8" - 16mm | 92460 | C-25 | 25' IC Cable (7.6m) | 24 | 10.9 |
| | 92465 | C-26 | 50' IC Cable (15.2m) | 43 | 19.5 |
| | 92470 | C-27 | 75' IC Cable (22.9m) | 63 | 28.6 |
| | 43647 | C-24 | 100' IC Cable (30.5m) | 84 | 38.1 |
| 3/4" - 20mm | 92475 | C-28 | 25' IC Cable (7.6m) | 30 | 13.6 |
| | 92480 | C-29 | 50' IC Cable (15.2m) | 60 | 27.2 |
| | 41212 | C-75 | 75' IC Cable (22.9m) | 93 | 42.5 |
| | 41697 | C-100 | 100' IC Cable (30.5m) | 122 | 55.3 |









Hollow Core Cables

| | Catalog No. | Model No. | Description | Weight | |
|-------------|-------------|-----------|-----------------------|--------|------|
| | | | | lb. | kg |
| 5/8" - 16mm | 32737 | C-27HC | 75' HC Cable (22.9m) | 52¾ | 23.9 |
| | 58192 | C-24HC | 100' HC Cable (30.5m) | 70½ | 32.1 |
| 3/4" - 20mm | 47427 | C-75HC | 75' HC Cable (22.9m) | 75 | 34.0 |
| | 47432 | C-100HC | 100' HC Cable (30.5m) | 100 | 45.5 |

Leaders and Pig Tails







| | Catalog No. | Model No. | Description | Weight | |
|---|-------------|-----------|------------------------|--------|------|
| | | | | lb. | kg |
|  | 92555 | T-458 | 5/8" x 2' Leader | 2 | 0.85 |
| | 92560 | T-468 | 3/4" x 2' Leader | 2¾ | 1.25 |
|  | 44122 | — | 5/8" Pigtail, 4½" Long | 2½ | 1.13 |
| | 44117 | — | ¾" Pigtail, 6" Long | 3½ | 1.59 |

Accessories

| | Catalog No. | Model No. | Description | Weight | |
|---|-------------|-----------|--------------------------------------|------------|----------|
| | | | | lb. | kg |
|  | 43637 | A-7558 | Drum Assembly w/5/8" Pigtail | 33 | 15 |
| | 41982 | A-7534 | Drum Assembly w/¾" Pigtail | 37½ | 17.0 |
|  | 43642 | A-75 | AUTOFEED Assembly | 8 | 3.5 |
| | 41992 | — | C-100IC Kit w/Tools, ¾" x 100' | — | — |
|  | 49032 | — | Front Guide Hose Assembly | 3 | 1.3 |
|  | 46015 | E-453 | Allen Wrench | — | — |
|  | 41937 | — | RIDGID Leather Drain Cleaning Gloves | ½ | 0.2 |
| | 70032 | — | RIDGID PVC Drain Cleaning Gloves | ½ | 0.2 |
|  | 59360 | A-3 | Tool Box | 5 | 2.3 |
|  | 59987 | — | Cable Rust Inhibitor 1 GAL. | 8½ | 3.9 |
| | | | | oz. | g |
|  | 31487 | A-7570 | 5/8" Repair Splicer | 1½ | 43 |
| | 92805 | A-6582 | 5/8" Male Coupling | 1 | 28 |
| | 92810 | A-6583 | 5/8" Female Coupling | 2 | 57 |
|  | 31492 | A-7571 | ¾" Repair Splicer | 2 | 57 |
| | 92880 | B-6840 | ¾" Male Coupling | 1 | 28 |
| | 92885 | B-6841 | ¾" Female Coupling | 2 | 57 |

Tools and Replacement Blades – Fit 5/8" and 3/4" Cables

C-24, C-25, C-26, C-27, C-28, C-29, C-75, C-100, C-27HC, C-24HC, C-75HC and C-100HC

| | Catalog No. | Model No. | Description | Replacement | |
|---|---|-----------|--------------------------|--------------------|---------|
| | | | | Blade(s) | Holder* |
|  | 92485 | T-403 | P-Trap Cutter, 3" | 92835 | 92900 |
| | 92490 | T-404 | P-Trap Cutter, 3½" | 92840 | 92900 |
|  | 92495 | T-406 | Spear Blade, 1¾" | 92850 | 92915 |
|  | 92500 | T-407 | Retrieving Auger, 29/16" | — | — |
|  | 92505 | T-408 | Sawtooth Cutter, 3" | 92890 | 92915 |
|  | 51762 | T-409 | H-D Bulb Auger, 1¾" | — | — |
|  | 92510 | T-411 | Double Cutter, 2" | 92815 | 92905 |
| | 92515 | T-412 | Double Cutter, 2½" | 92820 | 92905 |
| | 92520 | T-413 | Double Cutter, 3" | 92825 | 92910 |
| | 92525 | T-414 | Double Cutter, 4" | 92830 | 92910 |
| | 92530 | T-416 | Double Cutter, 6" | 92855 | 92910 |
| |  | 92535 | T-432 | 3-Blade Cutter, 2" | 92860 |
| 92540 | | T-433 | 3-Blade Cutter, 3" | 92865 | 92895 |
| 92545 | | T-434 | 3-Blade Cutter, 4" | 92870 | 92895 |
| 92550 | | T-436 | 3-Blade Cutter, 6" | 92875 | 92895 |

QUICK-CONNECT CABLE & TOOLS

Rotate pin one-half turn in either direction to quickly add cable or tools:

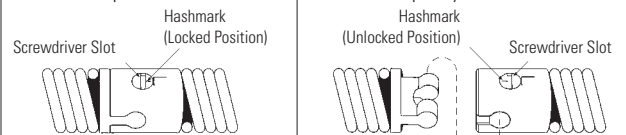

LOCKED

Hashmark "CLOSED" aligned with "L" stamped on coupling.

UNLOCKED

Hashmark "OPEN" aligned opposite "L" stamped on coupling.

Coupling features stainless steel pin and spring; eliminates need for punches, stands, or expansion pins.

For C-24, C-25, C-26, C-27, C-28, C-29, C-75, C-100, C-27HC, C-24HC, C-75HC, and C-100HC.

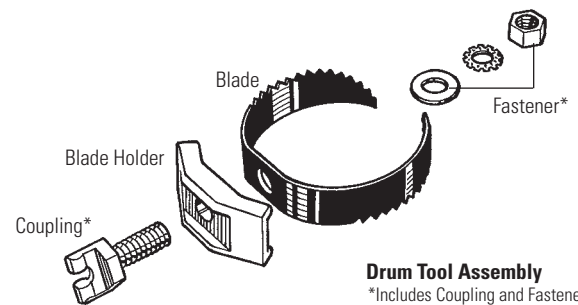

Drum Tool Assembly
*Includes Coupling and Fastener

Cable Control & Performance –

When Tool Engages Tough Obstructions

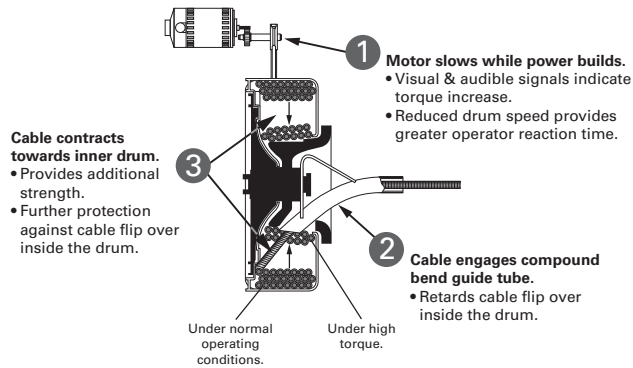

Accessories

| | Catalog No. | Model No. | Description | Weight | |
|--|-------------|-----------|--------------------------------------|------------|----------|
| | | | | lb. | kg |
| | 60042 | A-7534D | Drum Assembly w/3/4" Pigtail | 31 | 14 |
| | 61107 | A-7558D | Drum Assembly w/5/8" Pigtail | 30 | 13.6 |
| | 60047 | A-75DR | Drum Only | 20 | 9 |
| | 60032 | A-75PF | AUTOFEED Assembly | 10 | 4.5 |
| | 60037 | | AUTOFEED Spacers | | |
| | 41992 | | C-100 IC Kit w/Tools 3/4" x 100' | | |
| | 49032 | | Front Guide Hose Assembly | 3 | 1.3 |
| | 41937 | – | RIDGID Leather Drain Cleaning Gloves | .5 | 0.2 |
| | 70032 | – | RIDGID PVC Drain Cleaning Gloves | .5 | 0.2 |
| | 59360 | A-3 | Tool Box | 5 | 2.3 |
| | 59987 | | Cable Rust Inhibitor 1 GAL. | 8.5 | 3.9 |
| | | | | oz. | g |
| | 31487 | A-7570 | 5/8" Repair Splicer | 1½ | 43 |
| | 92805 | A-6582 | 5/8" Male Coupling | 1 | 28 |
| | 92810 | A-6583 | 5/8" Female Coupling | 2 | 57 |
| | 31492 | A-7571 | 3/4" Repair Splicer | 2 | 56 |
| | 92880 | B-6840 | 3/4" Male Coupling | 1 | 28 |
| | 92885 | B-6841 | 3/4" Female Coupling | 2 | 57 |

QUICK-CONNECT CABLE & TOOLS

Rotate pin one-half turn in either direction to quickly add cable or tools:

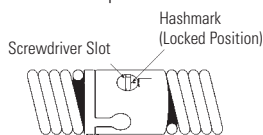

LOCKED
Hashmark "CLOSED" aligned with "L" stamped on coupling.

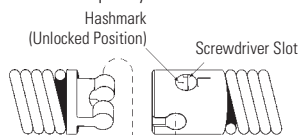

UNLOCKED
Hashmark "OPEN" aligned opposite "L" stamped on coupling.

Coupling features stainless steel pin and spring; eliminates need for punches, stands, or expansion pins.

Inner Core (IC) Cables

Good flexibility and more cleaning power to the cable end.

| | Catalog No. | Model No. | Description | Weight | |
|-------------|-------------|-----------|-----------------------|--------|------|
| | | | | lb. | kg |
| 5/8" - 16mm | 92460 | C-25 | 25' IC Cable (7.6m) | 24 | 10.9 |
| | 92465 | C-26 | 50' IC Cable (15.2m) | 43 | 19.5 |
| | 92470 | C-27 | 75' IC Cable (22.9m) | 63 | 28.6 |
| | 43647 | C-24 | 100' IC Cable (30.5m) | 84 | 38.1 |
| 3/4" - 20mm | 92475 | C-28 | 25' IC Cable (7.6m) | 30 | 13.6 |
| | 92480 | C-29 | 50' IC Cable (15.2m) | 60 | 27.2 |
| | 41212 | C-75 | 75' IC Cable (22.9m) | 93 | 42.5 |
| | 41697 | C-100 | 100' IC Cable (30.5m) | 122 | 55.3 |

Hollow Core (HC) Cables

| | Catalog No. | Model No. | Description | Weight | |
|-------------|-------------|-----------|-----------------------|--------|------|
| | | | | lb. | kg |
| 5/8" - 16mm | 32737 | C-27HC | 75' HC Cable (22.9m) | 52¾ | 23.9 |
| | 58192 | C-24HC | 100' HC Cable (30.5m) | 70½ | 32.0 |
| 3/4" - 20mm | 47427 | C-75HC | 75' HC Cable (22.9m) | 75 | 34.0 |
| | 47432 | C-100HC | 100' HC Cable (30.5m) | 100 | 45.5 |

Leaders and Pigtails

| | Catalog No. | Model No. | Description | Weight | |
|--|-------------|-----------|------------------|--------|------|
| | | | | lb. | kg |
| | 92555 | T-458 | 5/8" x 2' Leader | 2 | 0.85 |
| | 92560 | T-468 | 3/4" x 2' Leader | 2¾ | 1.25 |
| | 44122 | — | 5/8" Pigtail | 2½ | 1.13 |
| | 44117 | — | 3/4" Pigtail | 3½ | 1.59 |

Tools and Replacement Blades – Fits 5/8" and 3/4" Cables

C-24, C-25, C-26, C-27, C-28, C-29, C-75, C-100, C-24HC, C-27HC, C-75HC and C-100HC

| | Catalog No. | Model No. | Description | Replacement | |
|--|-------------|-----------|--------------------|-------------|--------|
| | | | | Blade(s) | Holder |
| | 92485 | T-403 | P-Trap Cutter, 3" | 92835 | 92900 |
| | 92490 | T-404 | P-Trap Cutter, 3½" | 92840 | 92900 |
| | 92495 | T-406 | Grease Blade | 92850 | 92915 |
| | 92500 | T-407 | Retrieving Auger | – | – |
| | 92505 | T-408 | Sawtooth Cutter | 92890 | 92915 |
| | 51762 | T-409 | H-D Bulb Auger | – | – |
| | 92510 | T-411 | Double Cutter, 2" | 92815 | 92905 |
| | 92515 | T-412 | Double Cutter, 2½" | 92820 | 92905 |
| | 92520 | T-413 | Double Cutter, 3" | 92825 | 92910 |
| | 92525 | T-414 | Double Cutter, 4" | 92830 | 92910 |
| | 92530 | T-416 | Double Cutter, 6" | 92855 | 92910 |
| | 92535 | T-432 | 3-Blade Cutter, 2" | 92860 | 92895 |
| | 92540 | T-433 | 3-Blade Cutter, 3" | 92865 | 92895 |
| | 92545 | T-434 | 3-Blade Cutter, 4" | 92870 | 92895 |
| | 92550 | T-436 | 3-Blade Cutter, 6" | 92875 | 92895 |